

# INSTALLATION INSTRUCTIONS

## 541-Bath Light

WS-54127/WS-54139

# MODERN FORMS

**CAUTION:** To prevent electrical shock, ensure electricity has been turned off at the circuit breaker before beginning.

- Read all instructions before installing.
- System is intended for installation by a licensed electrician in accordance with the National Electrical Code (NEC) and local regulations.
- When handling the fixture, do not apply pressure to the LEDs. Hold the fixture by the base only.
- Retain installation instructions for future maintenance reference.

**WARNING:** All parts must be used as indicated in these instructions. This product is designed for use only with the supplied parts and/or accessories designated for use by Modern Forms. Substitution of parts or accessories not designated for use with this product by Modern Forms could result in personal injury or property damage, and will void the warranty. Contact an authorized dealer or the manufacturer if any parts are damaged or missing.

**MAINTENANCE NOTE:** Coastal conditions may cause mineral and residue build-up on the fixture. We recommend that customers in coastal areas clean all external surfaces of the fixture once every two weeks with a wet cloth.

**MISE EN GARDE:** Pour éviter tout choc électrique, assurez-vous que le disjoncteur soit mis hors tension avant de commencer.

- Lisez toutes les instructions avant l'installation.
- Le système doit être installé par un électricien licencié conformément au code national de l'électricité (NEC), et également aux règlements locaux.
- Lors de la manipulation du luminaire, n'appuyez pas sur les LED. Tenez-le uniquement par la base.

**ATTENTION:** Toutes les pièces doivent être utilisées comme indiqué dans ces instructions. Ce produit est conçu pour être utilisé seulement avec les pièces et/ou accessoires fournis pour être utilisés avec les produits Modern Forms. Remplacer des pièces ou accessoires non conçus pour ce produit Modern Forms pourrait causer des dommages corporels ou matériels et pourrait également causer l'annulation de la garantie. Veuillez contacter un revendeur autorisé ou le fabricant si des pièces manquent ou sont endommagées.

**NOTE D'ENTRETIEN:** Les conditions côtières peut causer une accumulation de minéraux et de résidus sur le luminaire. Nous recommandons aux clients qui résident dans les zones côtières de nettoyer toutes les surfaces externes du luminaire une fois toutes les deux semaines avec un chiffon humide.

## HARDWARE

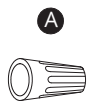

Wire Connector  
Qty:3+1Extra



Wire Connector  
Qty:2+1Extra



Mounting Screw  
Qty:2+1 Extra



Plastic Anchor  
Qty:4+2Extra



Wood Screw  
Qty: 4+2Extra

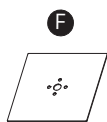

Square Plate  
Qty:2pcs



Round Plate  
Qty:2pcs



Mounting Bracket A  
Qty:1pc



Mounting Bracket B  
Qty:2pcs



Driver  
Qty:1pc

modernforms.com  
Phone (800) 526.2588  
Fax (800) 526.2585

Headquarters/Eastern Distribution Center  
44 Harbor Park Drive  
Port Washington, NY 11050

Central Distribution Center  
1600 Distribution Ct  
Lithia Springs, GA 30122

Western Distribution Center  
1750 Archibald Avenue  
Ontario, CA 91760



# INSTALLATION INSTRUCTIONS

## 541-Bath Light

WS-54127/WS-54139

# MODERN FORMS

### PREPARATION

1. Shut off the power at the circuit breaker and remove existing fixture, including the crossbar.
2. Carefully unpack your new fixture and lay out all the parts on a clear area. Be careful not to lose any small parts necessary for installation.

### MOUNTING WITH JUNCTION BOX (Fig. 1)

3. Drill two mounting holes in the wall aligned with the hole location in the mounting bracket B (I), parallel to the junction box center, 24" or 36" in distance (refer to the mounting hole dimensions). Then insert the plastic anchors (D).
4. Choose between a square or round plate (F or G). Using wood screw (E), secure the plate and mounting bracket B (I) to the plastic anchors (D).
5. Connect the driver's (J) input wires to junction box wires as shown in Fig. 3, make sure that all wire connectors (A) are secured. If your junction box has a green or bare copper ground wire, connect the fixture's ground wire to it. Otherwise, connect the fixture's ground wire directly to the back plate using the screw provided. After wires are connected, tuck driver and connectors carefully inside the junction box.
6. Secure the cross bar to the junction box using standard junction box screws that comes with the junction box.  
Note: (i) Using any other non-original-manufacturer provided junction box screw may result in safety issue;  
(ii) The side of the mounting plate marked "GND" must face out.  
(iii) Ensure the cross bar and junction box screws sit flush with or are recessed into the wall.
7. Choose the desired round or square plate (F or G) to cover the junction box, thread the driver's output wire through the hole of the plate. Secure it to the cross bar using the mounting bracket A (H).
8. Detach the cover from both standoffs. Connect the driver's output wires to power feed standoff wires, red to red, and black to black. Make sure that all wire connectors (B) are secured, then tuck them carefully inside the power feed standoff.
9. Insert the LED tube to both standoffs, ensure the electric end of the tube is connected to the power feed standoff, and the non-electrical end is connected to the standard standoff.  
Note: Fixture will not illuminate with improper connection.
10. Secure the standoff over the mounting bracket A (H) and mounting bracket B (I) with mounting screw (C).
11. Attach the covers to both standoffs to complete installation.

### DIMMING WIRING INFORMATION (Fig. 4)

12. This fixture features electronic low voltage (ELV) or 0-10V dimming capabilities. See notes below for specific dimming wires information.
13. To utilize ELV dimming: use wires black (hot), white (neutral) and green ground wire (ground).
14. To utilize 0-10V dimming: use wire purple (dim+), gray (dim-), black (hot), white (neutral) and green ground wire (ground).

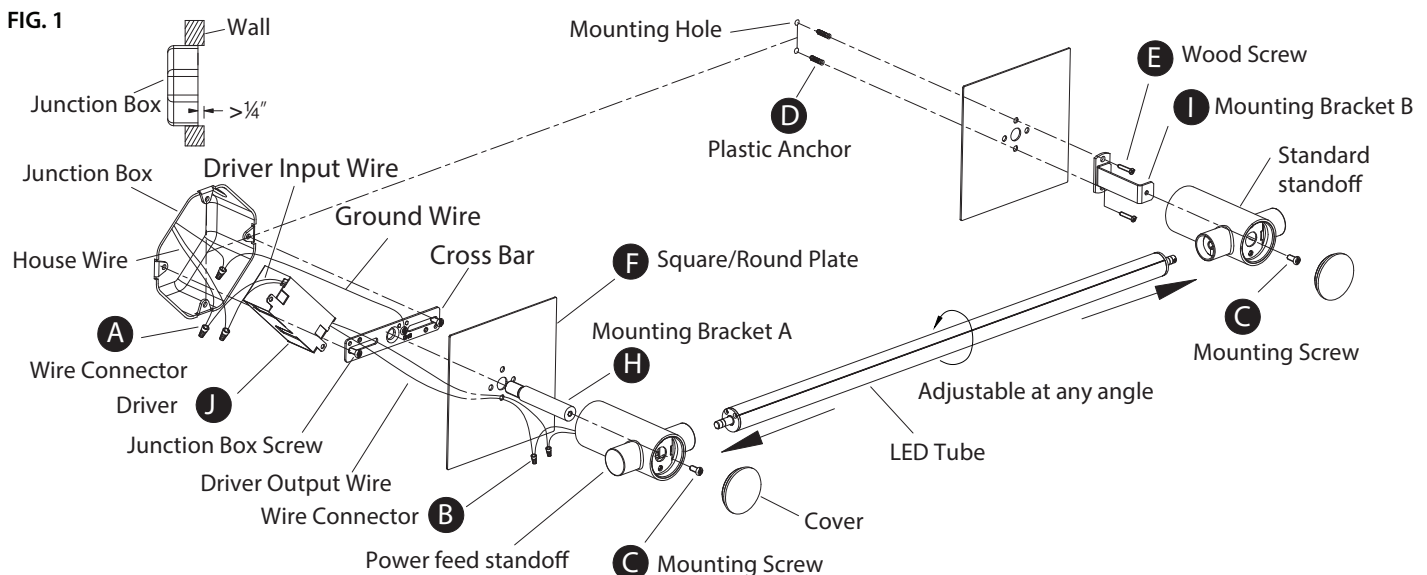

modernforms.com  
Phone (800) 526.2588  
Fax (800) 526.2585

Headquarters/Eastern Distribution Center  
44 Harbor Park Drive  
Port Washington, NY 11050

Central Distribution Center  
1600 Distribution Ct  
Lithia Springs, GA 30122

Western Distribution Center  
1750 Archibald Avenue  
Ontario, CA 91760



# INSTALLATION INSTRUCTIONS

## 541-Bath Light

WS-54127/WS-54139

# MODERN FORMS

### MOUNTING WITHOUT JUNCTION BOX (Fig. 2)

3. Drill a small access hole in the wall and pull the driver's output wires through the wall.
  4. Center mounting bracket B (I) directly beside the access hole, drill 2 mounting holes that are in aligned with the hole location of mounting bracket B (I). Repeat and drill 2 additional mounting holes in parallel, 24" or 36" in distance (refer to mounting hole dimensions below), then insert the plastic anchors (D).
  5. Secure mounting bracket B (I) to the plastic anchors (D) using the wood screws (E) on each end.
  6. Detach the cover from both standoffs. Connect the driver's output wires to power feed standoff wires, red to red, and black to black. Make sure that all wire connectors (B) are secured, then tuck them carefully inside the power feed standoff.
  7. Insert the LED tube to both standoffs, ensure the electric end of the tube is connected to the power feed standoff, and non-electrical end is connected to the standard standoff.
- Note: Fixture will not illuminate with improper connection.
8. Secure the standoff over mounting bracket B (I) with mounting screw (C).
  9. Attach the covers to both standoffs to complete installation.

FIG. 2

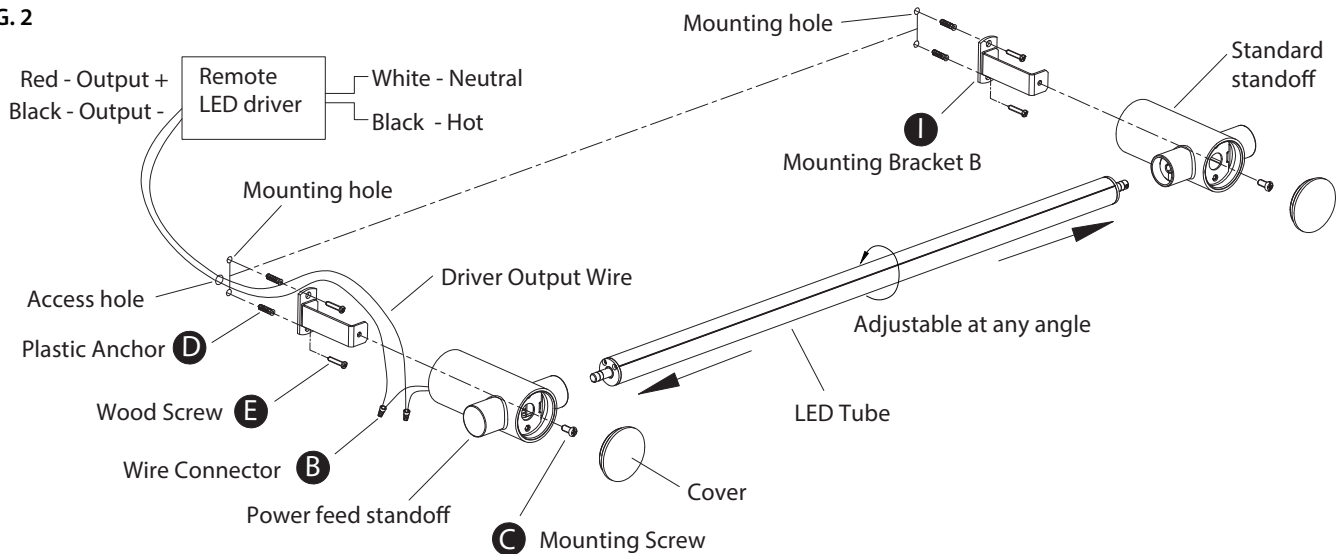
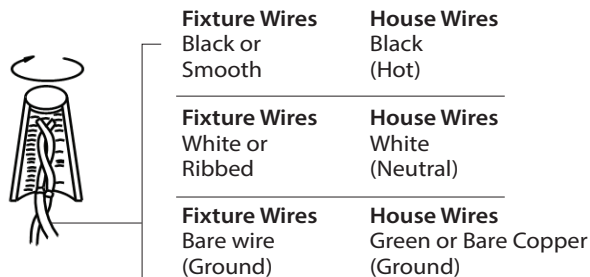
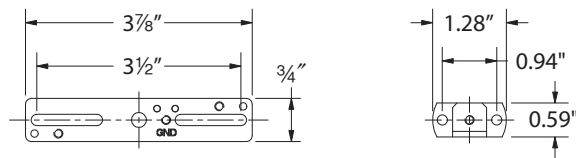

FIG. 3 Wiring



Mounting Backplate Dimension



Mounting Hole Dimensions

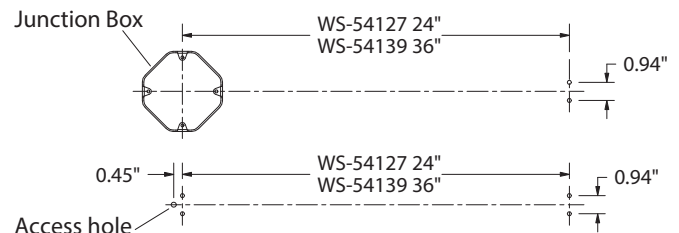
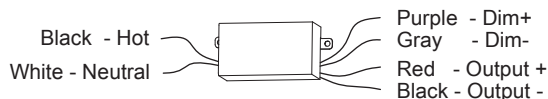

FIG.4 Driver Wiring



modernforms.com  
Phone (800) 526.2588  
Fax (800) 526.2585

Headquarters/Eastern Distribution Center  
44 Harbor Park Drive  
Port Washington, NY 11050

Central Distribution Center  
1600 Distribution Ct  
Lithia Springs, GA 30122

Western Distribution Center  
1750 Archibald Avenue  
Ontario, CA 91760

