

INSTALLATION INSTRUCTION

348-LED Pendant

PD-34865



MODERN FORMS
A WAC LIGHTING COMPANY

WARNING

IMPORTANT: NEVER attempt any work without shutting off the electricity.

- Read all instructions before installing.
- System is intended for installation by a qualified electrician in accordance with the National Electrical Code and local regulations.
- Go to the main fuse box, or circuit breaker. Place the main power switch in the "OFF" position and unscrew the fuse(s) or switch "OFF" the circuit breaker switch(es) that control the power to the fixture or room that you are working on.
- Place the wall switch in the "OFF" position.

CAUTION

- All parts must be used as indicated in these instructions. Do not substitute any parts, leave parts out, or use any parts that are worn out or broken. Failure to follow this instruction could invalidate the ETL/CETL listing of this fixture.
CAUTION When handling the fixture, do not apply pressure to the LEDs. Hold the fixture by the base only.

AVERTISSEMENT

IMPORTANT : Coupez l'électricité avant TOUTE manipulation.

- Lisez toutes les instructions avant d'installer.
- Système est destiné à être installé par un électricien qualifié en conformité avec le code national de l'électricité et les règlements locaux.
- Accédez au panneau central de disjoncteurs ou de fusibles de votre demeure et placez l'interrupteur principal en position d'arrêt (« OFF »).
- Placez l'interrupteur mural en position d'arrêt (« OFF »).

MISE EN GARDE

- Toutes les pièces doivent être utilisées tel qu'il est indiqué dans ces instructions. Ne remplacez pas les pièces, n'en laissez pas de côté et ne les utilisez pas si elles sont usées ou brisées. Le non-respect de ces instructions peut annuler l'homologation ETL/CETL du luminaire. MISE EN GARDE Ors de la manipulation de l'appareil, ne pas appliquer de pression à la LED, tenir l'appareil par la seule base.

ADVERTENCIA







IMPORTANTE: NUNCA intente hacer trabajos sin desconectar el suministro eléctrico.

- Lea y comprenda todas las instrucciones e ilustraciones por completo antes de proceder con el ensamblaje e instalación de esta lámpara.
- Sistema está diseñado para ser instalado por un electricista calificado, de acuerdo con el código eléctrico nacional y las normas locales.
- Diríjase a la caja de fusibles o a la caja del interruptor de circuito principal en su hogar. Coloque el interruptor de alimentación principal en la posición "OFF" (APAGADO).
- Coloque el interruptor de la pared en la posición "OFF" (APAGADO).

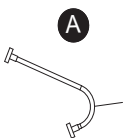
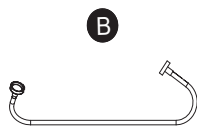
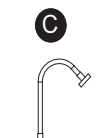
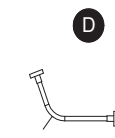
PRECAUCIÓN

- Todas las piezas deben usarse como lo indican estas instrucciones. No reemplace las piezas, no omita piezas durante la instalación ni utilice piezas gastadas o rotas. El incumplimiento de esta indicación podría invalidar la calificación ETL/CETL esta lámpara. PRECAUCIÓN Al manipular el aparato, no aplique presión a los LED, mantenga el aparato en la base sólo.

HARDWARE

								
Tube_A Setion QTY:1pcs Nickle Plating	Tube_B Setion QTY:1pcs Nickle Plating	Tube_C Setion QTY:1pcs Nickle Plating	Tube_D Setion QTY:1pcs Nickle Plating	Plastic Anchor QTY:2pcs+1Extra 7TCH421301	Drop Hanger QTY:2pcs+1Extra 4EAL572501NI Nickle Plating	Decorative Ring QTY:2pcs+1Extra 4MBC251006NI Nickle Plating	Wire Connector Qty: 3pcs+1 Extra 7EAC112201 P3	Junction Box Screw Qty: 2pcs+1 Extra 7MPF0825F1 #8-32x1 Nickle Plating

modernforms.com
Phone (800) 526.2588
Fax (800) 526.2585

Headquarters/Eastern Distribution Center
44 Harbor Park Drive
Port Washington, NY 11050

Central Distribution Center
1600 Distribution Ct
Lithia Springs, GA 30122

Western Distribution Center
1750 Archibald Avenue
Ontario, CA 91760









INSTALLATION INSTRUCTION

348-LED Pendant

PD-34865

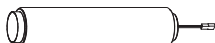

MODERN FORMS
A WAC LIGHTING COMPANY

J	K	L	M	N	O	P
						
Mounting Screw QTY: 1 Extra 7MPF0412S1 (NI) #8-32x1/2 Nickle Plating	Lighting Section with two Connectors QTY:5pcs	Lighting Section with male Connectors QTY:1pcs	Lighting Section with female Connectors QTY:1pcs	Wire Clamp QTY:2pcs+1Extra 4MPE090602NI Nickle Plating	Allen Screw Qty: 4pcs+1 Extra 7MPF0303K1 1/8"-40x1/8 Nickel Plating	Allen Wrench Qty: 1 Extra 7MPE155003

PREPARATION

1. Shut off the power at the circuit breaker and remove existing fixture, including the crossbar.
2. Carefully unpack your new fixture and lay out all the parts on a clear area. Be careful not to lose any small parts necessary for installation.

Fig.1

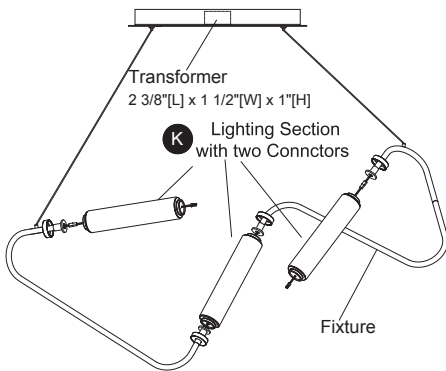

Fig.2

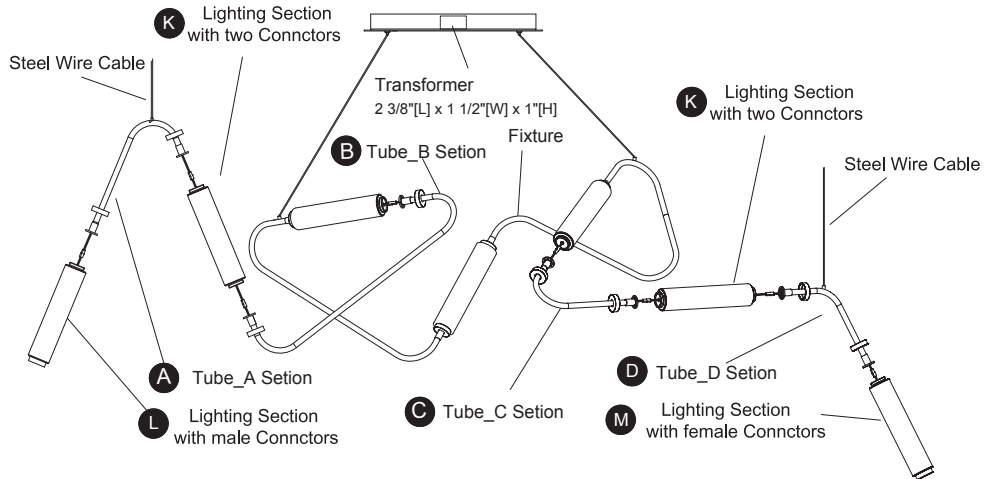

Fig.3

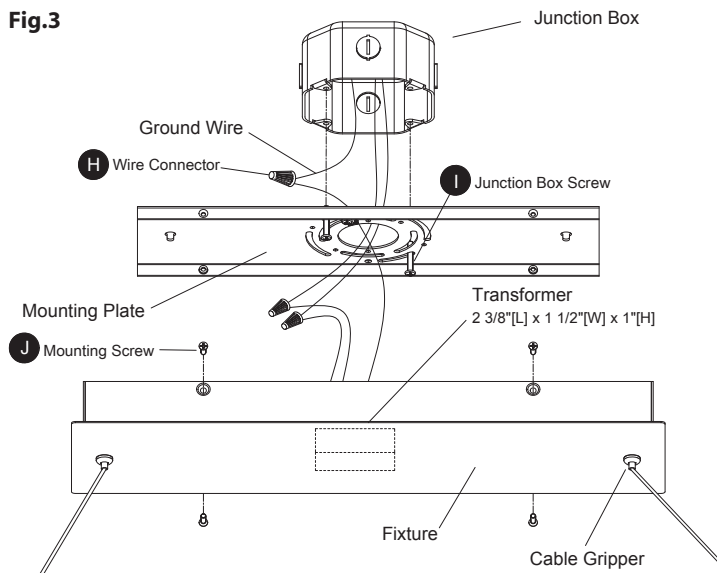
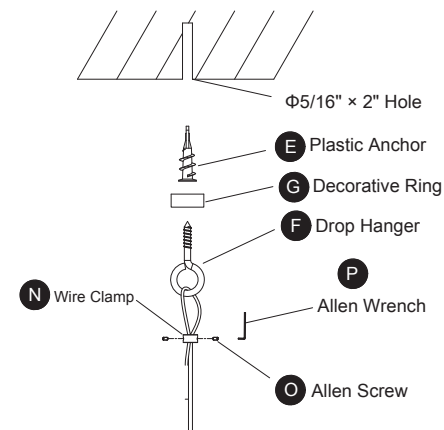

Fig.4



modernforms.com
Phone (800) 526.2588
Fax (800) 526.2585

Headquarters/Eastern Distribution Center
44 Harbor Park Drive
Port Washington, NY 11050

Central Distribution Center
1600 Distribution Ct
Lithia Springs, GA 30122

Western Distribution Center
1750 Archibald Avenue
Ontario, CA 91760



INSTALLATION INSTRUCTION

348-LED Pendant

PD-34865



MODERN FORMS
A WAC LIGHTING COMPANY

Fig.5

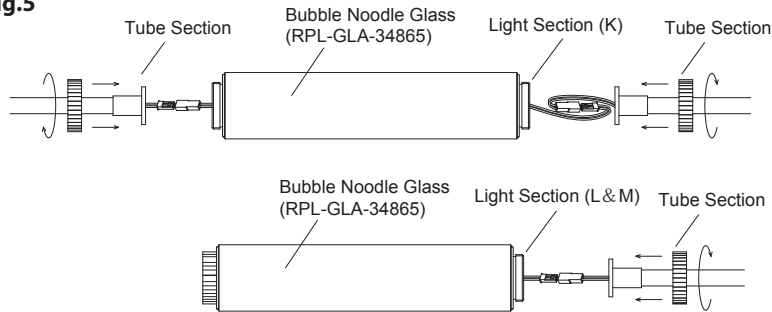

Fig.6 Wiring



Fixture Wires	House Wires
Black or Smooth	Black (Hot)
White or Ribbed	White (Neutral)
Bare wire (Ground)	Green or Bare Copper (Ground)

ASSEMBLE THE LIGHT(Fig. 1)

- Remove the mounting screw (J) as shown in Fig. 3.
- Secure the mounting plate to the switch box using junction box screws (I). The side of the mounting plate marked "GND" must face out.
- Connect the fixture's wire to three light section(K) as shown in Fig.1, and put the parts together as shown in Fig.5.
- Connect the fixture's wire to tube section(B and C) as shown in Fig.2, and put the parts together.
- Connect the fixture's wire to two light section(K) as shown in Fig.2, and put the parts together as shown in Fig.5.
- Connect the fixture's wire to tube section(A and D) as shown in Fig.2, and put the parts together.
- Connect the fixture's wire to the light section(L and M) as shown in Fig.2, and put the parts together as shown in Fig.5.

MOUNT ON JUNCTION BOX (Fig. 2)

- Connect the fixture's wire to switch box wires as shown in Fig. 3, making sure that all wire connectors (H) are secured as shown in Fig.6. If your outlet box has a green or bare copper ground wire, connect the fixture's ground wire to it. Otherwise, connect the fixture's ground wire directly to the back plate using the green screw provided. After wires are connected, tuck them carefully inside the switch box.
- Adjust the fixture wire length by pushing the cable grippers on the canopy and pulling the wires as desired .
- Secure the fixture to the mounting plate using the mounting screw (J).
- Use a drill to bore a 5/16"x2" hole in the ceiling.
- Knock the plastic anchor(E) in to the hole.
- Put two drop hanger(F) cross over the decorative ring(G) and screw they on the plastic anchor(E) as shown in Fig.4.
- Put the fixture steel wire cable through the wire clamp(N) and drop hanger , and then put it through the wire clamp(N) again as shown in Fig.4.
- Screw two allen screw(O)to each wire clamp by using the allen wrench(P).

BACK PLATE DIMENSIONS

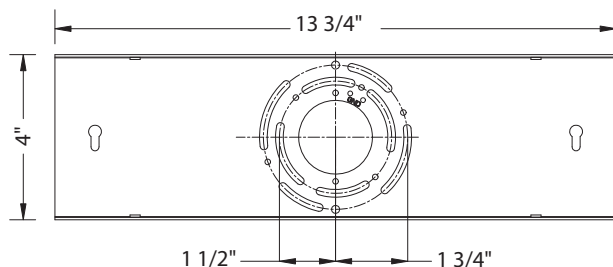

modernforms.com
Phone (800) 526.2588
Fax (800) 526.2585

Headquarters/Eastern Distribution Center
44 Harbor Park Drive
Port Washington, NY 11050

Central Distribution Center
1600 Distribution Ct
Lithia Springs, GA 30122

Western Distribution Center
1750 Archibald Avenue
Ontario, CA 91760

