

PALECEK®

601 PARR BOULEVARD | RICHMOND | CA 94801

WALL SCONCE INSTALLATION INSTRUCTIONS

VERALDI SCONCE

227979

PROFESSIONAL INSTALLATION REQUIRED

CAUTION: BEFORE INSTALLING FIXTURE, MAKE SURE THE POWER TO THE CIRCUIT IS TURNED OFF AT THE MAIN FUSE BOX / CIRCUIT BREAKER UTILITY BOX.

Important Safety Instructions:

- These instructions are provided for your safety. It is important that they are read carefully before use to ensure safe operation of the product.
- THIS PRODUCT MUST BE INSTALLED IN ACCORDANCE WITH THE APPLICABLE INSTALLATION CODES BY A PERSON FAMILIAR WITH THE CONSTRUCTION AND OPERATION OF THE PRODUCT AND THE HAZARDS INVOLVED.
- The lighting fixture is meant for indoor use. It must be connected only to 3-wire, single-phase electrical supply systems (provided with Ground wire or equivalent protection system).
- For your safety, it is strongly recommended that two people install the lighting fixture.
- This fixture has been rated for up to one (1) X **25 watt maximum Type B bulb** (not included). To avoid the risk of fire, do not exceed the recommended lamp wattage. Consider LED Bulbs if brighter light output is desired.
- DRY LOCATIONS ONLY.
- **Save these instructions.**





WARNING:

- **To reduce the risk of fire, electrical shock or personal injury, always turn off light fixture and allow it to cool prior to replacing light bulb.**
- **Do not touch bulb when fixture is turned on. Do not look directly at lit bulb.**
- **Keep flammable materials away from lit bulb.**
- **Check the cable properly for any loose or damaged connections.**
- **If the unit is no longer functioning, do not attempt to fix it by yourself. Only a qualified technician is allowed to disassemble and repair.**
- **If the external flexible cable cord of this luminaire is damaged it shall be exclusively replaced by a qualified electrician in order to avoid hazard.**

Pre-Assembly:

- Remove all parts and hardware from the box along with any plastic protective packaging. Do not discard contents until after assembly is complete to avoid accidentally discarding small parts or hardware.
- Lay the product out on the floor. If there is no carpet, cover the floor with a soft cloth so as not to scratch the finish of the light or the floor.

TOOLS REQUIRED (not included): Ladder, Phillips Head & Flat Blade Screwdrivers, Wire Cutter/Stripper and Electrical Tape.

Parts List:			
CODE	IMAGE	DESCRIPTION	QTY.
A		SCONCE FIXTURE	1 Pc.
B		MOUNTING PLATE	1 Pc.
C		MOUNTING SCREWS	2 Pcs.
D		WIRE CONNECTOR	3 Pcs.
E		BACK PLATE SCREWS	2 Pcs.

Installation Instructions:

1. **SHUT OFF THE MAIN ELECTRICAL SUPPLY FROM THE MAIN FUSE BOX/CIRCUIT BREAKER.**
2. Separate Mounting Plate (B) from Sconce Fixture (A) by removing the two Back Plate Screws (E). Do not discard Back Plate Screws (E) as these will be used later.

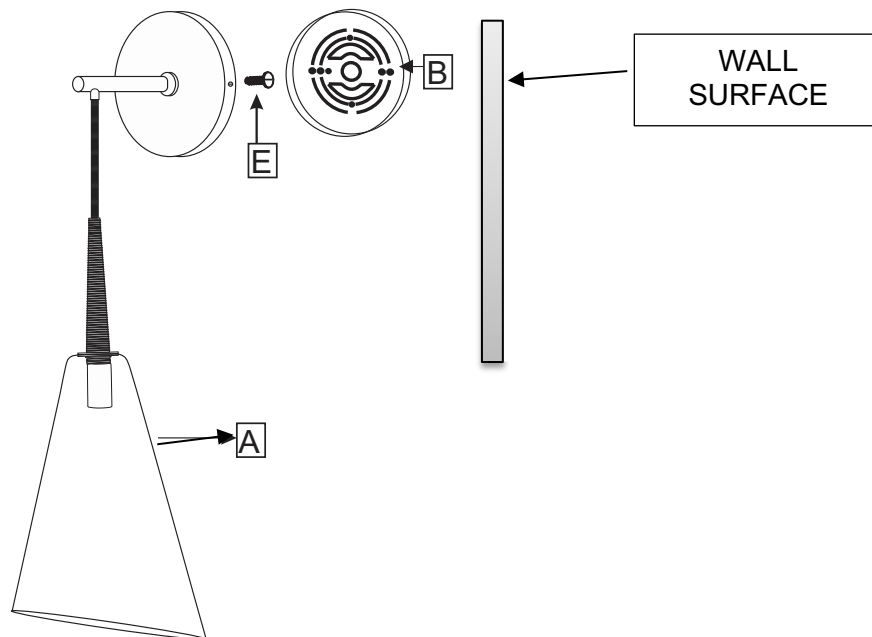

3. Gently pull existing wires out from the wall junction box and allow them to hang. The hot or live wire is often black and smooth or neutral wire is often white and ridged. Check to see if there is a ground wire that is green. If needed, use a pair of wire strippers to remove about 1/2 inch of insulation from each wire.

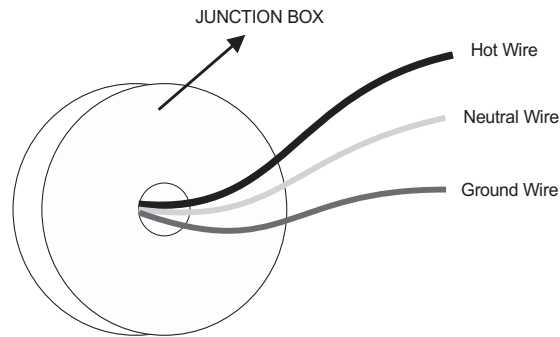

4. Insert the junction box wires through the center opening of the Mounting Plate (B). Attach the mounting plate to the wall Junction Box using the two Mounting Screws (C).

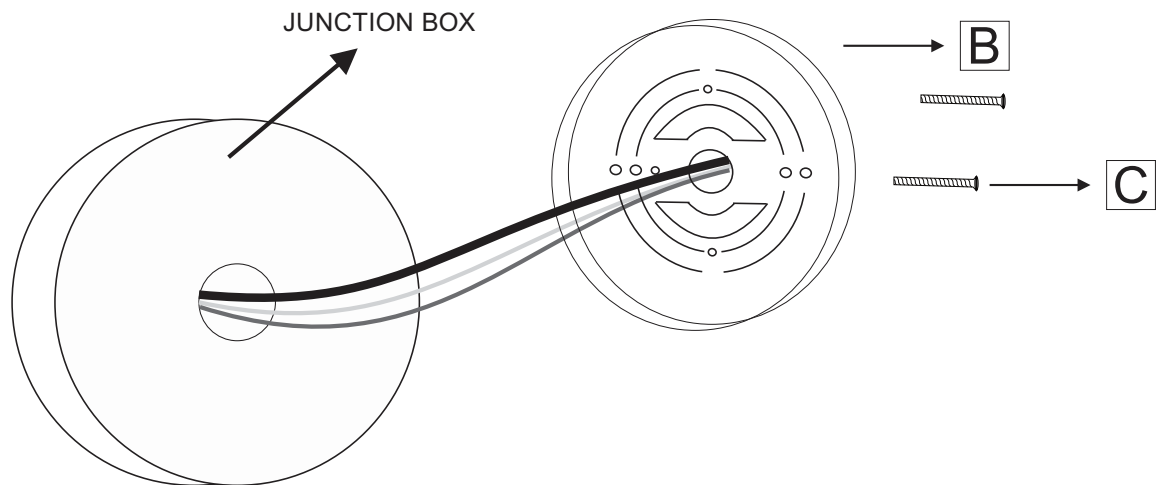

5. Establish electrical connections:

- Connect the NEUTRAL (-) FIXTURE WIRE to the NEUTRAL (-) JUNCTION BOX WIRE. Fasten each together with a wire connector (D) and wrap the connection with electrical tape. Be sure that no wire strands are exposed.
- Connect the HOT (+) FIXTURE WIRE to the HOT (+) JUNCTION BOX WIRE. Fasten each together with a wire connector (D) and wrap the connection with electrical tape. Be sure that no wire strands are exposed.
DO NOT REVERSE THE HOT (+) AND NEUTRAL (-) CONNECTIONS OR SAFETY WILL BE COMPROMISED.

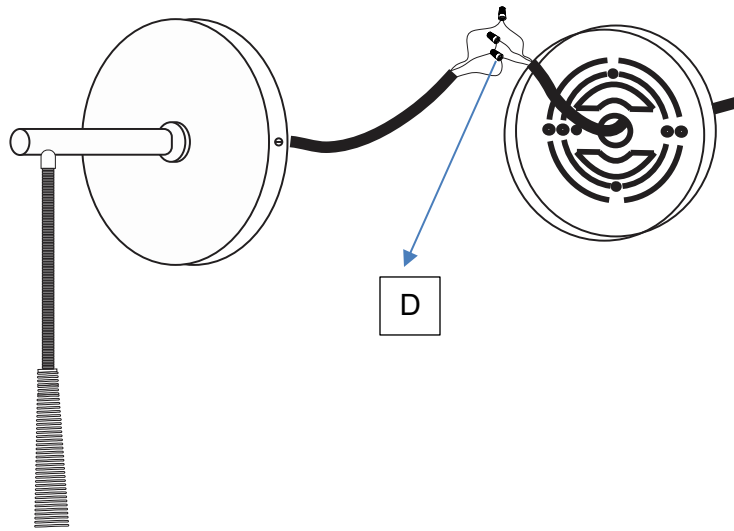

- c) Connect the **GROUND WIRE** of the fixture to the **GROUND J-BOX WIRE**. Fasten each together with a wire connector (D) and wrap the connection with electrical tape. Be sure that no wire strands are exposed. If there is no ground wire in the Junction-Box, use a screwdriver to secure the end of the fixture ground wire to the mounting plate (B). After wire connections, tighten the connectors on the wire joints.
6. After all connections are made, Insert the two Back Plate screws (E) and tighten each using a screwdriver until secure. Do not over-tighten the screws.

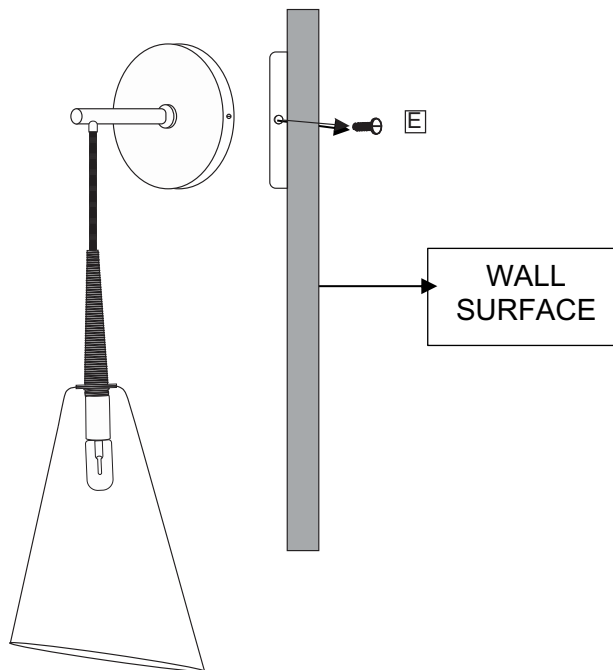

7. Insert One (1) X 25 **watt maximum Type B bulb** (not included) into the socket. **DO NOT EXCEED THERECOMMENDED WATTAGE**. Consider LED Bulbs if brighter light output is desired.
8. Restore power to ceiling outlet junction box and test fixture.
9. Installation is complete.

Care Instructions:

- Do not use abrasive cleaning solution as it may cause damage to the fixture's finish.
- Wipe clean with a soft, dry cloth or static duster.