

ASSEMBLY INSTRUCTIONS

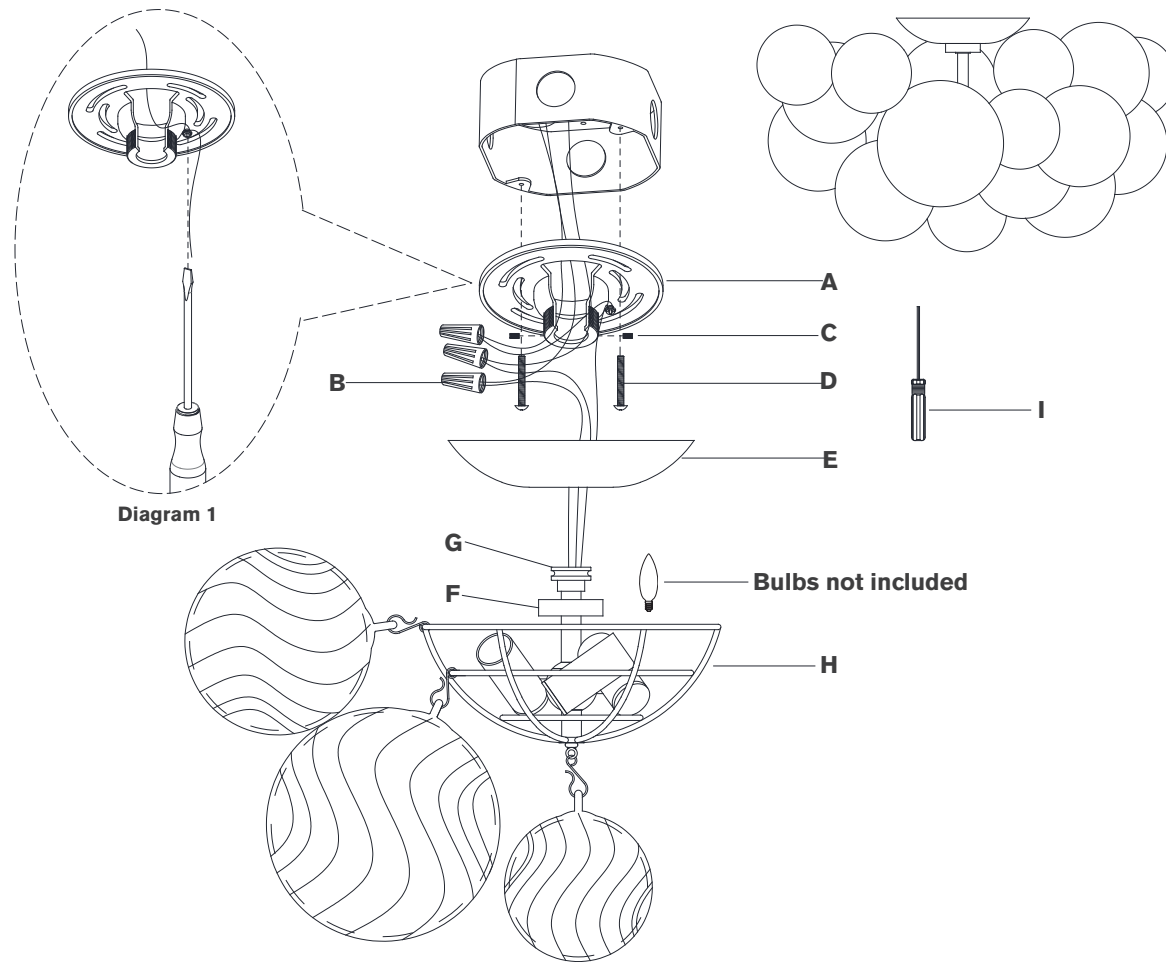

Talia Large Flush Mount

Item # JN 4112

NOTICE:

This light fixture should be installed in accordance with all applicable, local installation codes, and by a person familiar with the construction and operation of it, as well as the hazards involved. Inspect item and contents carefully. If any damage or defect is found, do not install. Retain all packaging material until installation is complete and approved.

TOOLS REQUIRED (NOT INCLUDED):

Phillips Screwdriver	Slotted Screwdriver	Wire Strippers
Slip Joint Pliers	Measuring Tape	Wire Cutters

1. Carefully remove all parts from the box. Place on a clean, soft surface.
2. Remove mounting plate (A) from canopy (E) by removing canopy ring (F).
3. Install mounting plate (A) to junction box and secure with mounting screws (D).
4. Slide canopy (E) down rod and rest on fixture, then hang fan mount (G) to center of mounting plate (A) and secure with set screws (C) using provided wrench (I).
5. Cut excess wires, being sure to leave enough to reach the junction box.
6. Separate two sides of molded wire, and strip insulation on each 5/8".
7. Wrap fixture ground wire (bare copper) around the green grounding screw (see diagram 1). Tighten. Continue fixture ground wire and connect to supply ground wire (usually green or bare copper) using wire nut (B).
8. Connect fixture neutral wire (ribbed) to the supply neutral wire (usually white) using wire nut (B).
9. Connect fixture hot wire (smooth with markings) to the supply hot wire (usually black) using wire nut (B).

NOTE: It is imperative that the fixture is grounded.

CAUTION: Do not reverse the hot and neutral connections.

ASSEMBLY INSTRUCTIONS

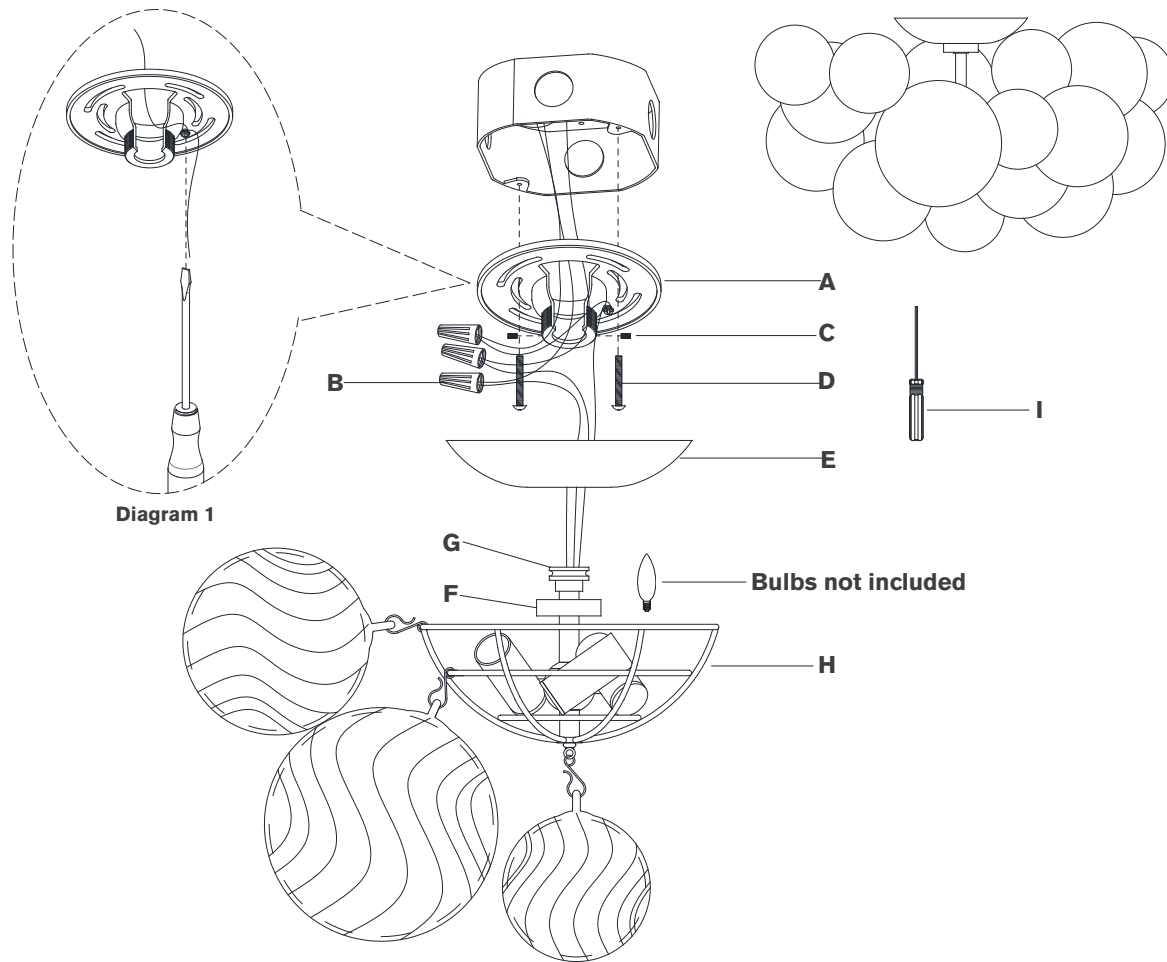

Talia Large Flush Mount

Item # JN 4112

NOTICE:

This light fixture should be installed in accordance with all applicable, local installation codes, and by a person familiar with the construction and operation of it, as well as the hazards involved. Inspect item and contents carefully. If any damage or defect is found, do not install. Retain all packaging material until installation is complete and approved.

10. Make sure all wire connections are tight, then carefully tuck into the junction box.
11. Install canopy (**E**) to mounting plate (**A**) and secure with canopy ring (**F**).
12. Insert light bulbs into the sockets.
13. Install glass balls starting from bottom (layer 1) and working your way to the top (layer 4) as shown in figures L1-L14.

Care Instructions: Clean only with a soft dry cloth or feather duster. Do not use abrasive or chemical agents.

ASSEMBLY INSTRUCTIONS

Talia Large Flush Mount

Item # JN 4112

NOTICE:

This light fixture should be installed in accordance with all applicable, local installation codes, and by a person familiar with the construction and operation of it, as well as the hazards involved. Inspect item and contents carefully. If any damage or defect is found, do not install. Retain all packaging material until installation is complete and approved.

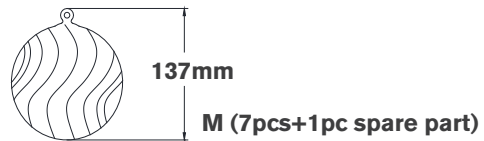
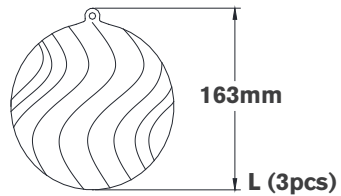
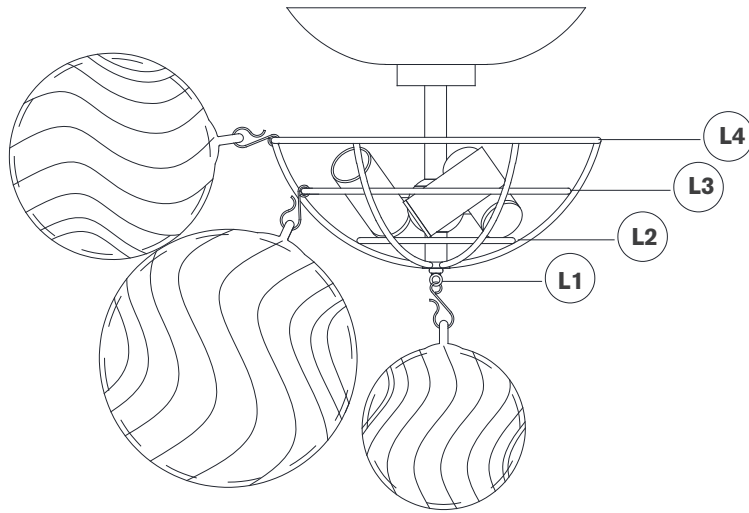

ASSEMBLY INSTRUCTIONS

Talia Large Flush Mount

Item # JN 4112

NOTICE:

This light fixture should be installed in accordance with all applicable, local installation codes, and by a person familiar with the construction and operation of it, as well as the hazards involved. Inspect item and contents carefully. If any damage or defect is found, do not install. Retain all packaging material until installation is complete and approved.

L1

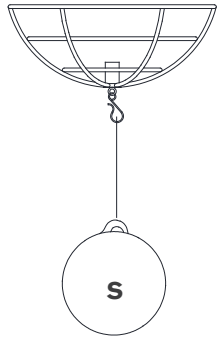

L2

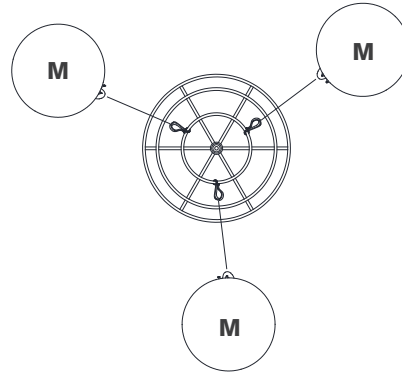

L3

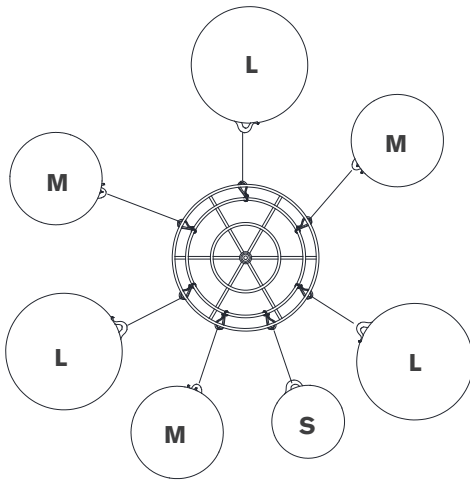

L4

