

# LED Step Light

**ER7110**  
INSTALLATION SHEET

## START FROM HERE

- Make sure **POWER** is **COMPLETELY OFF** at the fuse box.
- Have your fixture installed by a qualified licensed electrician
- Prepare everything in a clear area.
- Wear gloves at all times during this installation.
- Read instructions carefully before you start assembly.
- Keep this instruction sheet for future reference.

Technical Support: 1-855-855-8926

## Please Note:

- This Kuzco LED fixture comes with pre-wired LED module(s).
- Unless instructed to do so, please do not touch any part of the LED module(s) as any unnecessary contact with the module could cause permanent damage.
- For dimming, an ELV (Electronic Low Voltage) type of dimmer is required.
- 120V input

## INSTALLING FROM STUD WALLS

1. With the switch box secured to the wall, attach the fixture (2a). Make proper electrical connections (**black to hot "L", white to neutral "N", ground to "GND"**) with wire nuts (1d) provided in hardware package. Secure fixture (2a) to switch box (3a) with fixture screws (2b).

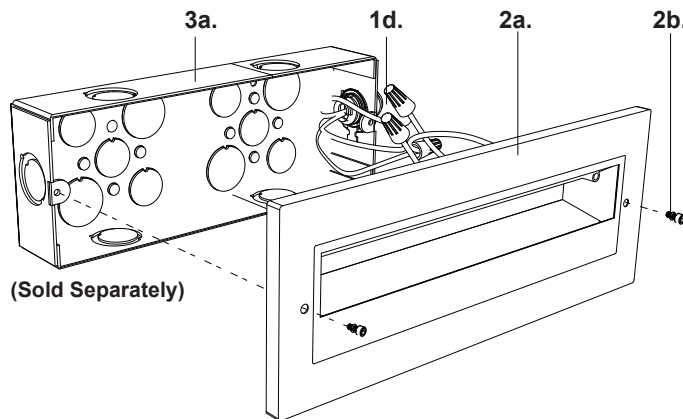

## INSTALLING THE CONCRETE BOX

1. The concrete box (1a) is suitable for installation in outdoor wall mount applications including concrete pour. **IMPORTANT NOTE:** For proper waterproof seal, ensure that Face A of the concrete box (1a) is flush against the finished wall (Illustration 1) such that the lip of the concrete box (1a) is protruding at least 2mm from the finished wall (Illustration 2).
2. Install the concrete box (1a) in opening using brackets (1e) by attaching them to the mounting surface using the appropriate screws (not provided).
3. Provide electrical wiring to the concrete box (1a) (according to local electrical code) by removing the conduit plug (1f) and using conduit with appropriate fittings (not provided). Ensure that all unused conduit openings are adequately closed/sealed with the conduit plug (1f). Pull supply wires into the concrete box (1a).
4. If ready to install fixture, proceed to Step 5, otherwise use cover plate (1c) to protect supply wires inside concrete box (1a) and secure with cover plate screws (1b).

## INSTALLING THE FIXTURE

5. Remove cover plate (1c) from the concrete box (1a) by removing cover plate screws (1b). Make proper electrical connections (**black to hot "L", white to neutral "N", ground to "GND"**) with wire nuts (1d) provided in hardware package.
6. Verify that the housing gasket is free of debris to ensure proper seal. Align the fixture body (2a) to the concrete box (1a) and use the fixture screws (2b) to secure to concrete box (1a).
7. **Outdoor use:** To prevent moisture from entering the concrete box (1a) and causing a short, seal around the top and side perimeter between the fixture and the wall surface with weather resistant caulking (Illustration 3). The space at the bottom should be left un-caulked to prevent moisture build up.

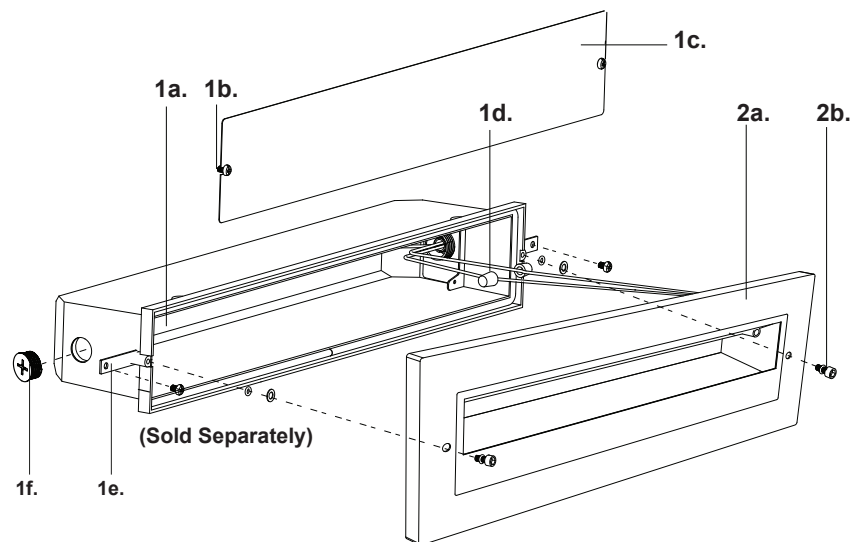
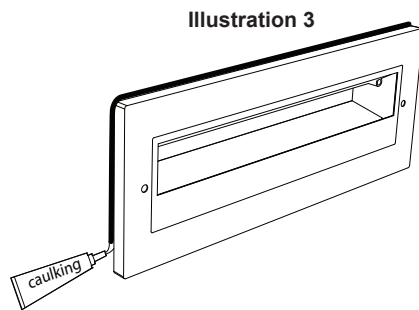
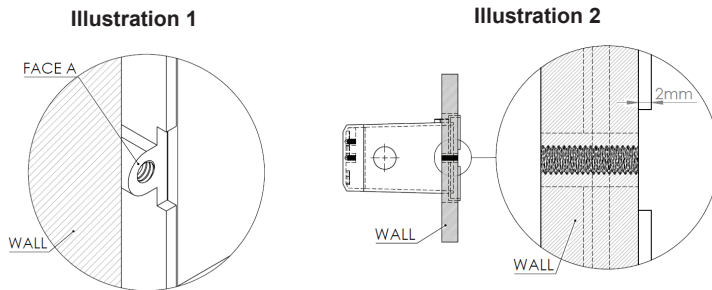

**KUZCO**

19054 28th Avenue Surrey, BC Canada V3Z 6M3  
T: 604 538 7162 TF: 1-855 85 KUZCO F: 604 538 7196  
W: kuzcolighting.com  
20220302