

# Artemide®

## La Petite

design  
A. Quaglio  
M. Simonelli

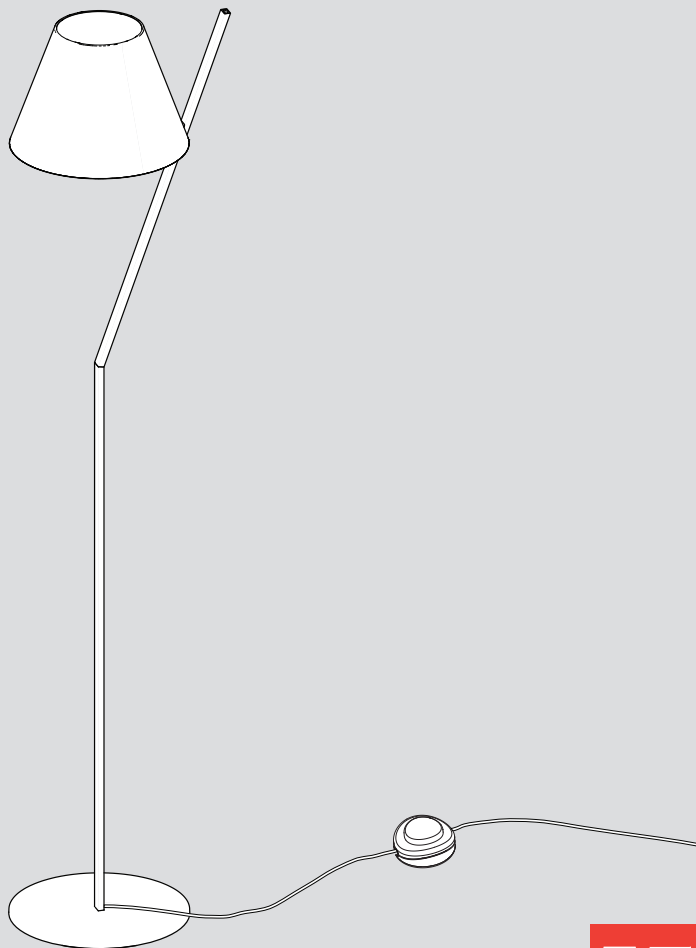



i

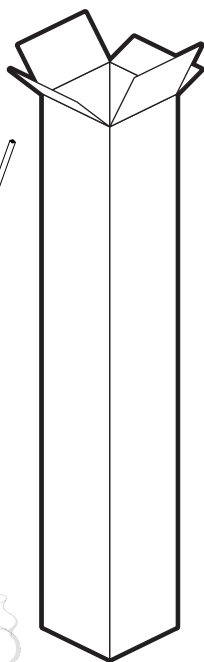
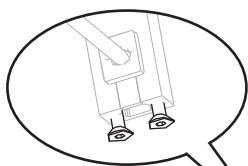
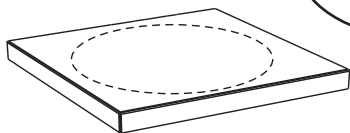
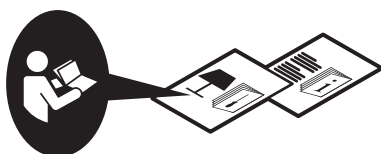
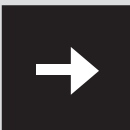
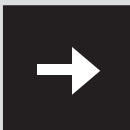
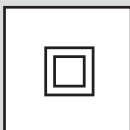
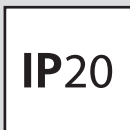



1

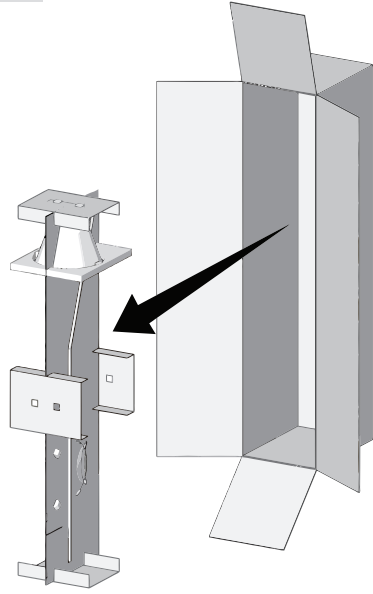

2

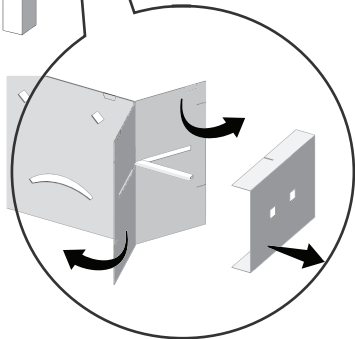
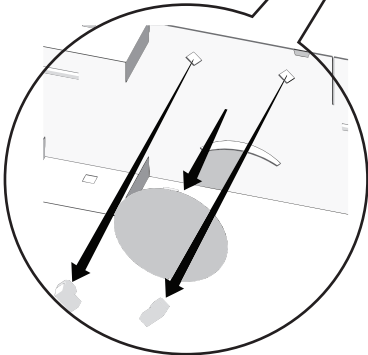
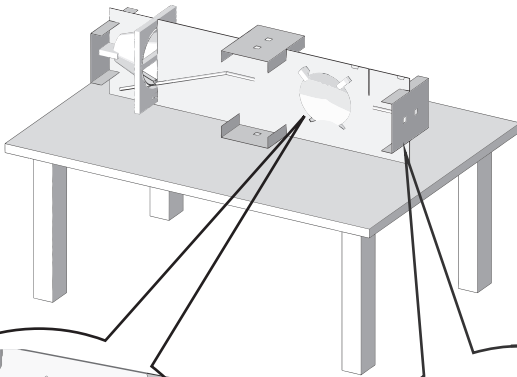

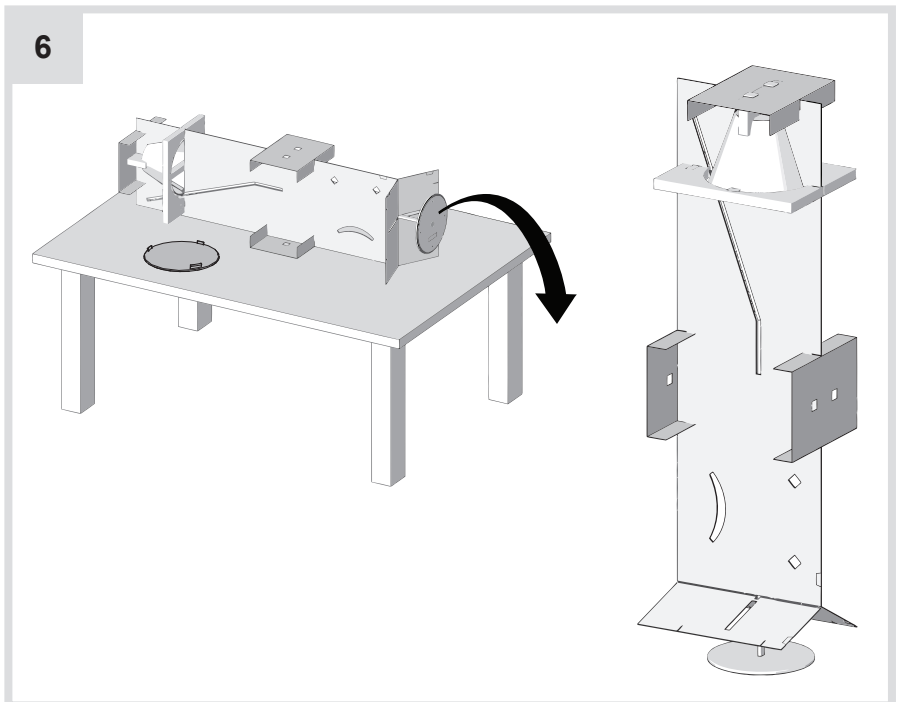
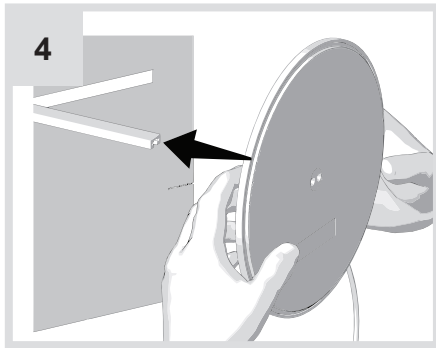
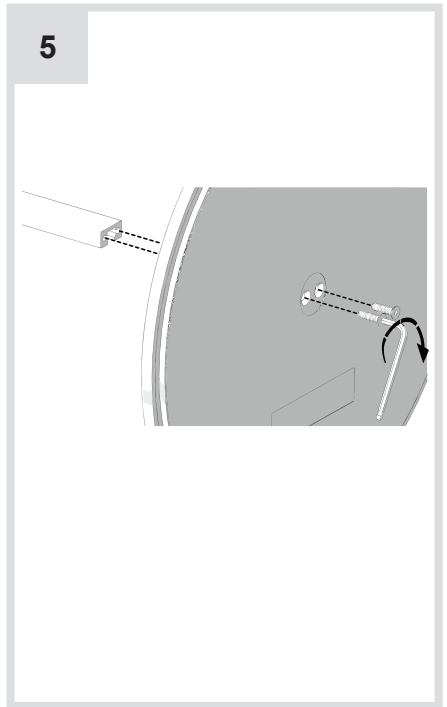
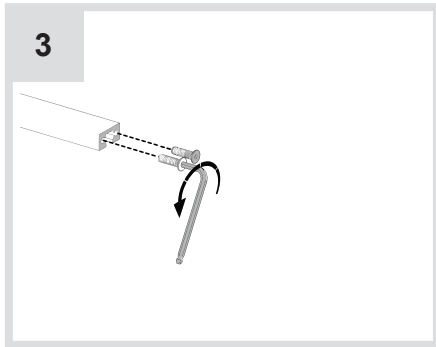

7

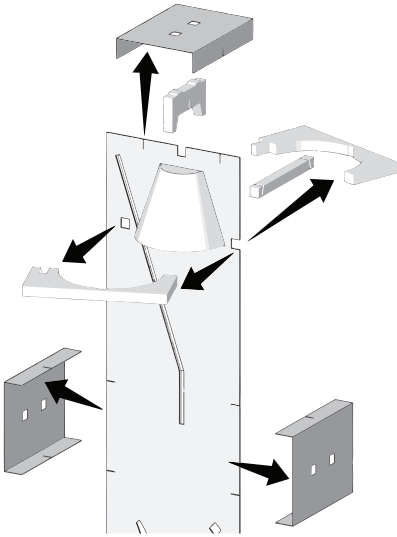

8

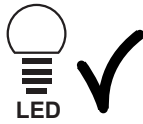
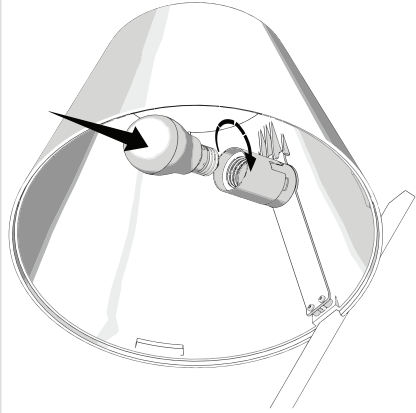

9

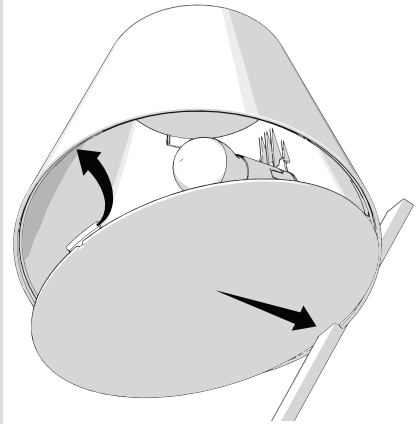

10

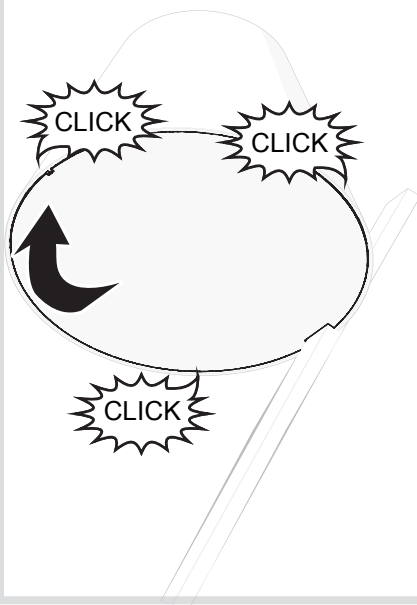

11



12

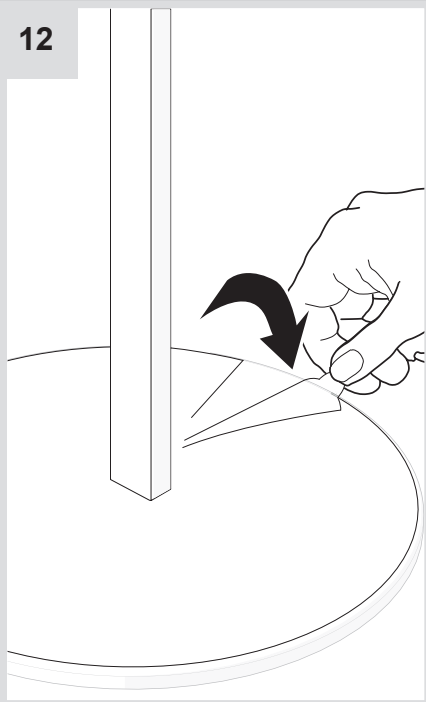

13

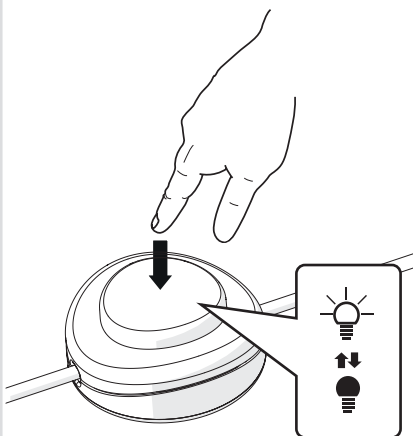

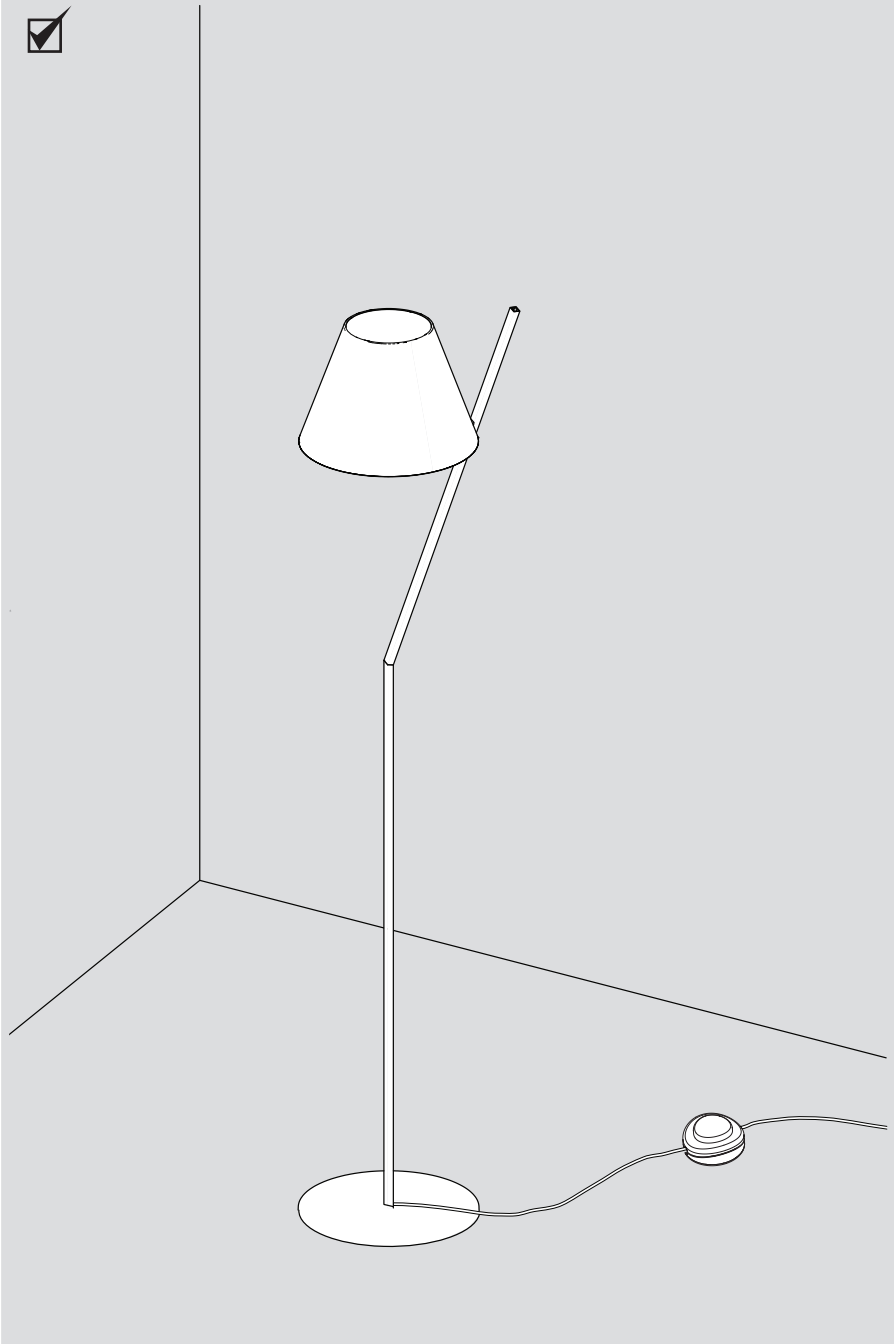



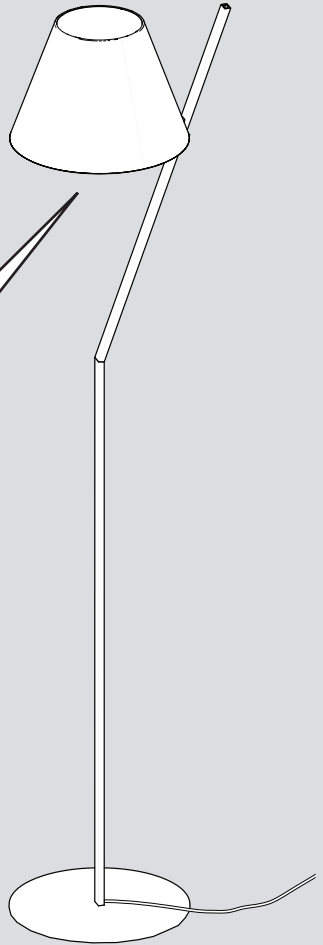

i



**MAX 12W LED - E27**



LED



LED



HALO



HALO



FLUO

**for USA/CANADA only**

**MAX 12W - E26  
cULus SBLED**



LED



LED



HALO



HALO



FLUO



1

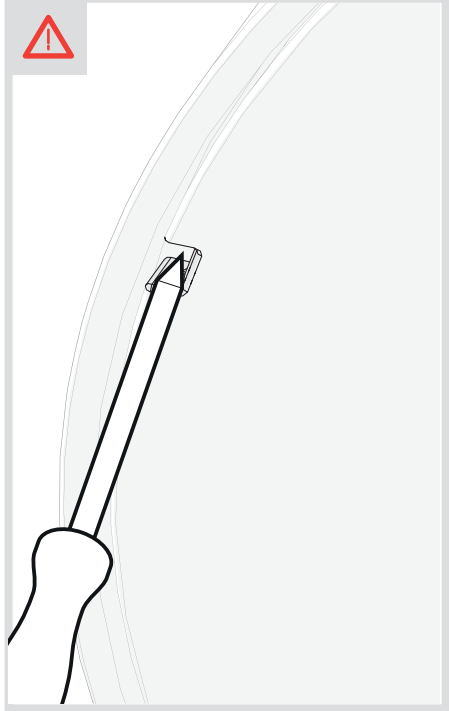
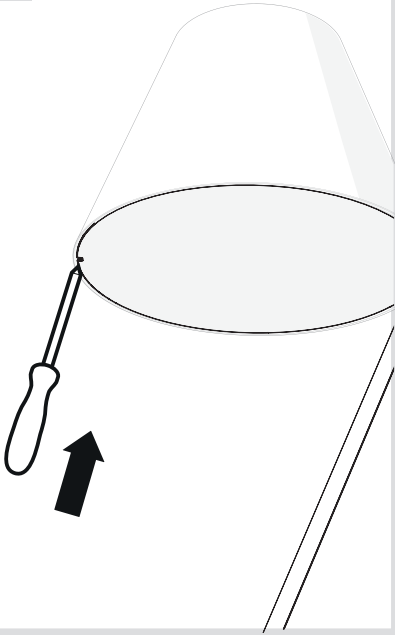

2

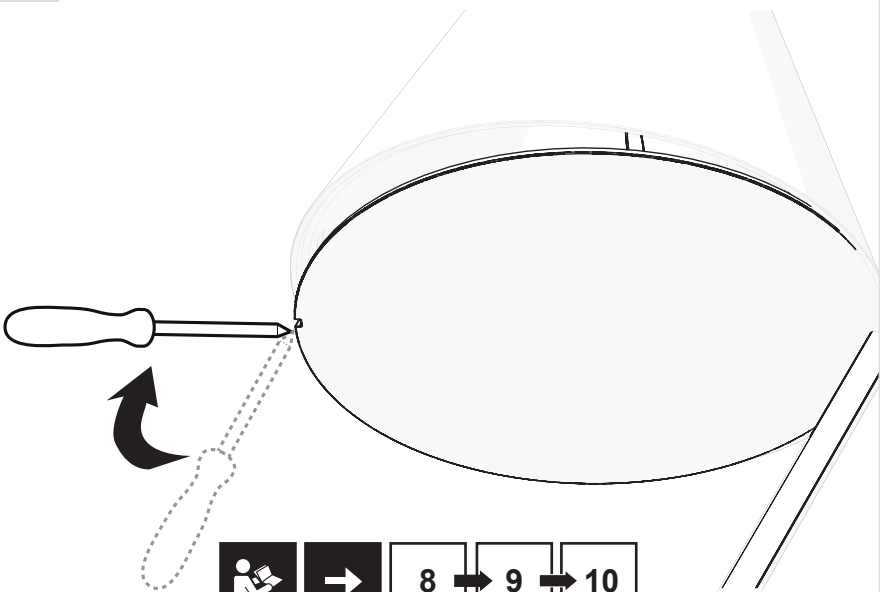

8

→ 9

→ 10

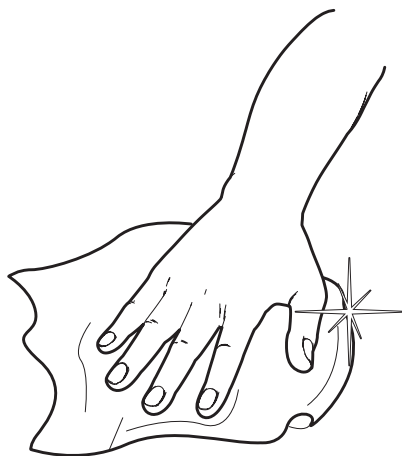



# Artemide®



## **Artemide**

via Bergamo, 18  
20010 Pregnana M.se (MI)  
ITALIA

tel. +39 02 935 181  
fax +39 02 935 90 254  
fax +39 02 935 90 496

[www.artemide.com](http://www.artemide.com)

VAT IT00846890150

## **Artemide Inc.**

250 Karin Lane  
Hicksville, NY 11801

Tel. 631 694 9292  
Toll Free 1-877-Art-9111  
Fax 631 694 9275

[www.artemide.net](http://www.artemide.net)

## **Artemide Ltée/Ltd.**

11105 rue Renaude Lapointe  
Montréal, Québec H1J 2T4

Tel. 514 323 6537  
Toll Free 888 777 2783  
Fax 514 323 8864

[www.artemide.net](http://www.artemide.net)

cod. Y513000659