

# Artemide®

## Meteorite

design  
Pio & Tito Toso

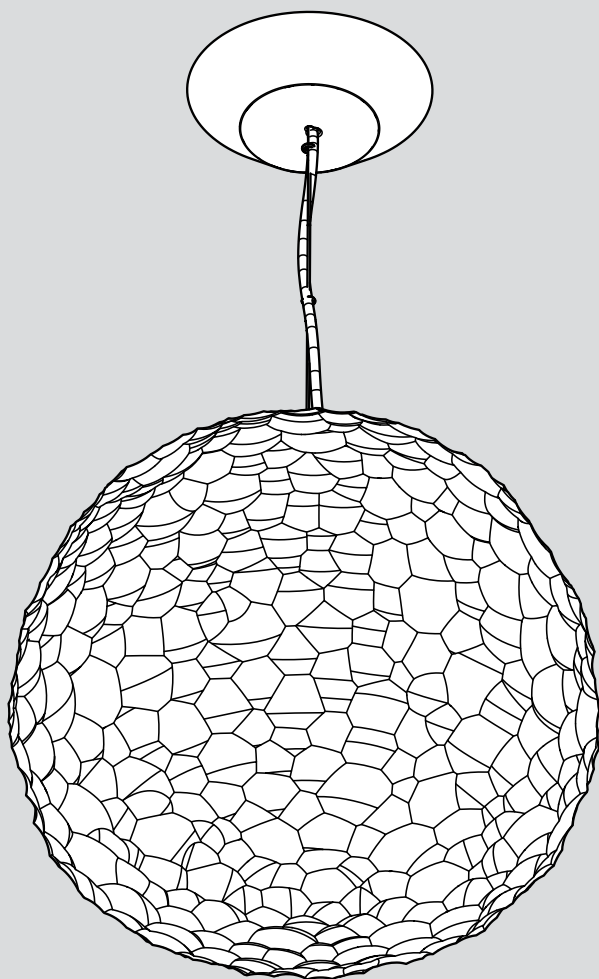



i

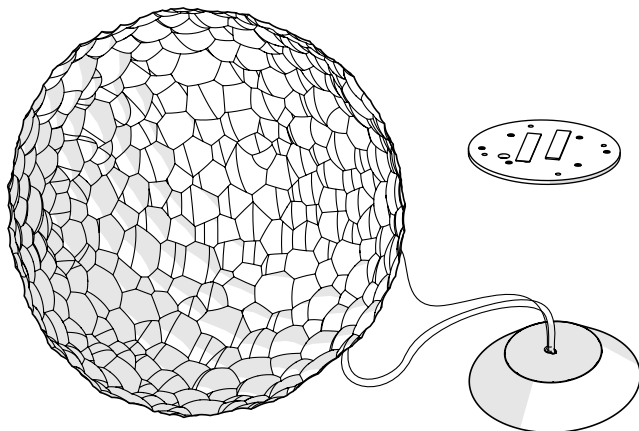
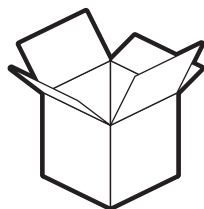
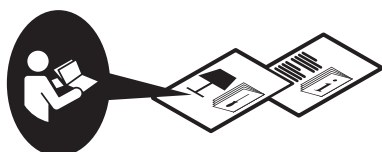

1

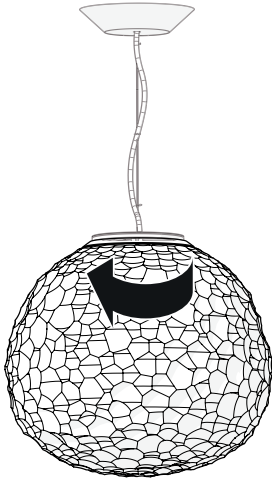

2

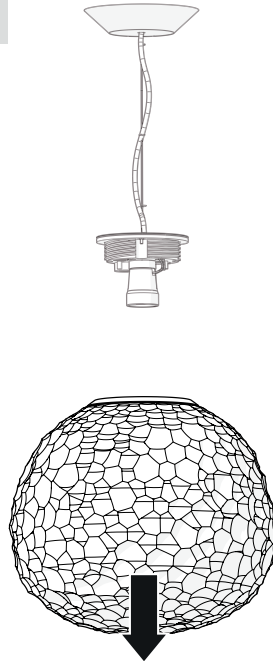

3

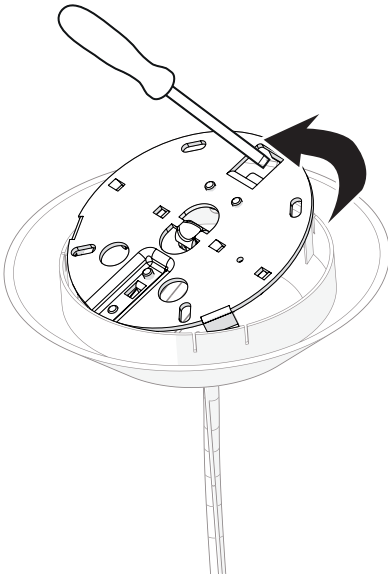

4

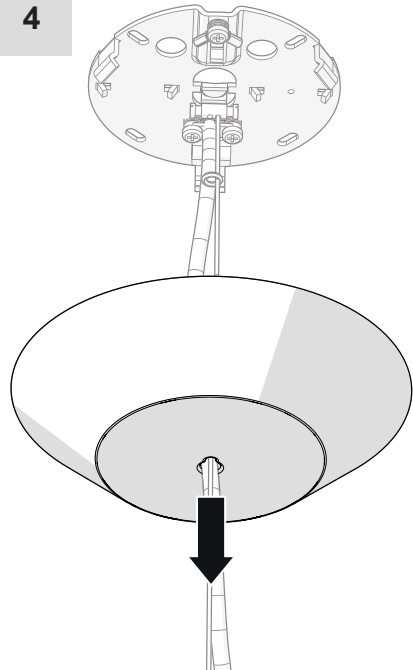

5

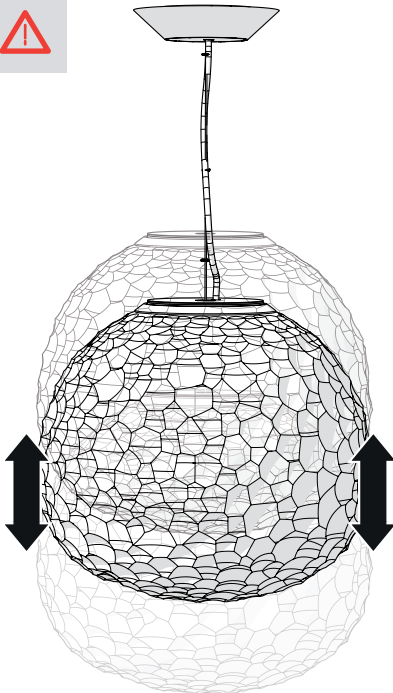
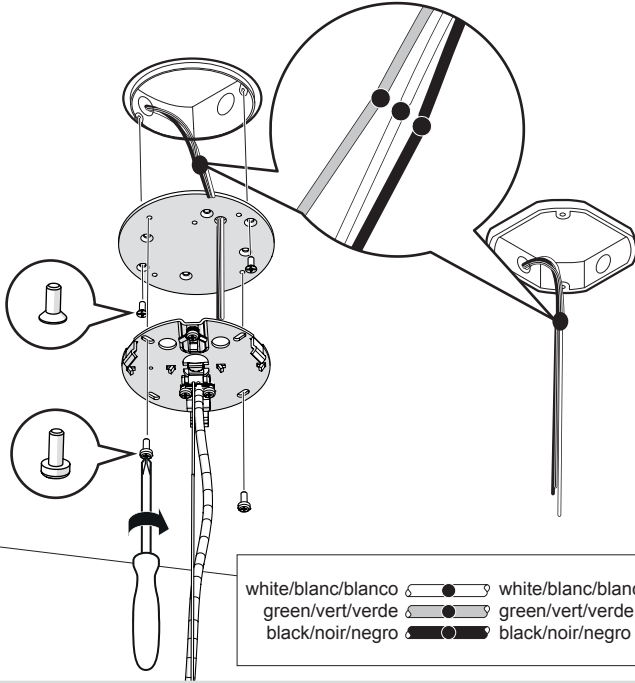

6

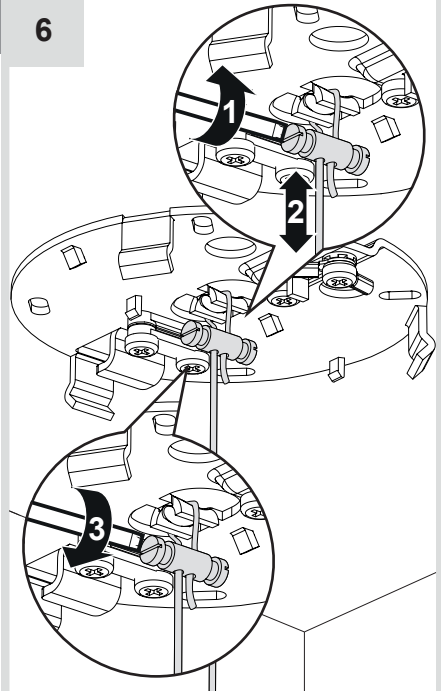

7

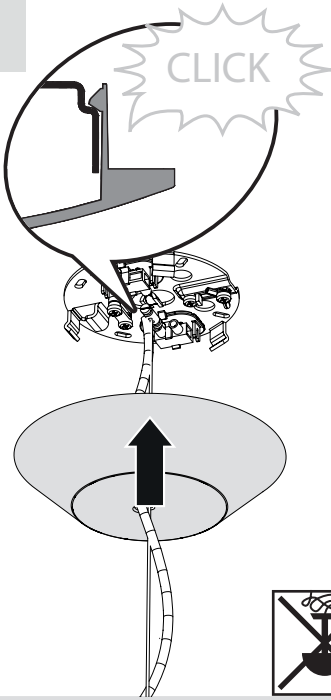

8

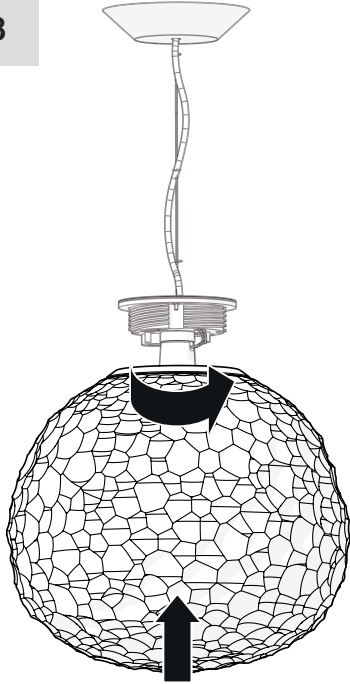

1

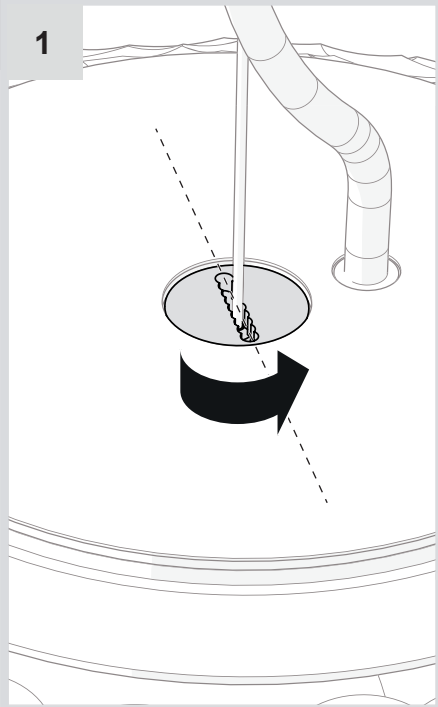

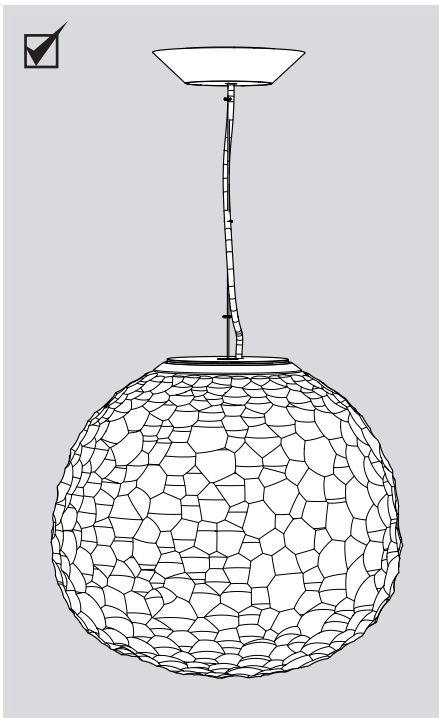
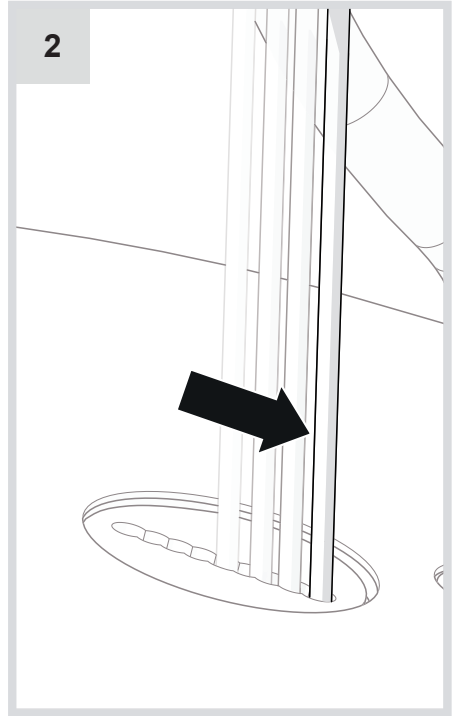
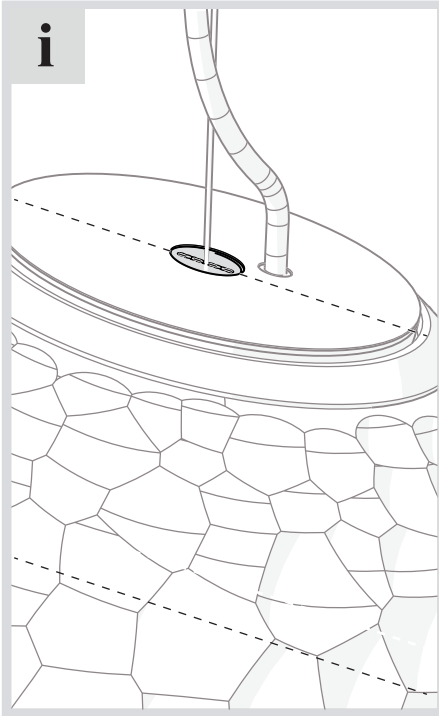

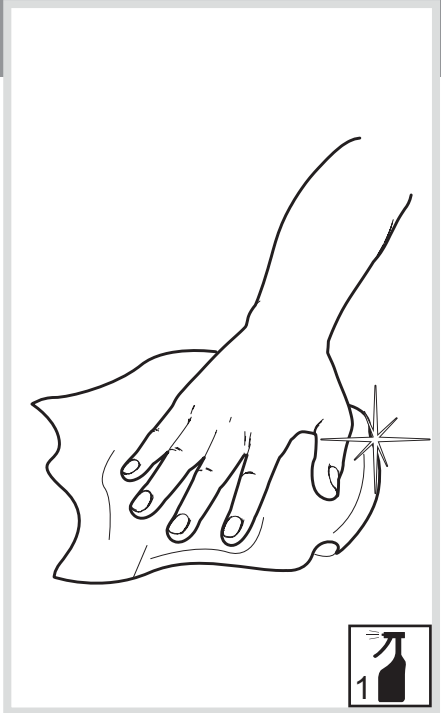

# Artemide®



## **Artemide**

via Bergamo, 18  
20010 Pregnana M.se (MI)  
ITALIA

tel. +39 02 935 181  
fax +39 02 935 90 254  
fax +39 02 935 90 496

[www.artemide.com](http://www.artemide.com)

VAT IT00846890150

## **Artemide Inc.**

1980 New Highway  
Farmingdale NY 11735

Tel. 631 694 9292  
Toll Free 1-877-Art-9111  
Fax 631 694 9275

[www.artemide.us](http://www.artemide.us)

## **Artemide Ltée/Ltd.**

11105 rue Renaude Lapointe  
Montréal, Québec H1J 2T4

Tel. 514 323 6537  
Toll Free 888 777 2783  
Fax 514 323 8864

[www.artemide.ca](http://www.artemide.ca)

cod. Y513000212