

Gaia, earth mother.

design Jean-François Crochet
terzani.com







Product Name

Gaia
linear chandelier

Materials

raw metal | raw brass

Finishes | Code

-  raw metal
OG41S N8 C8
-  raw brass
OG41S P1 C8
-  nickel
OG41S E7 C8
-  gold plated
OG41S L6 C8
-  matt walnut | raw brass
OG41S P2 C8

Body

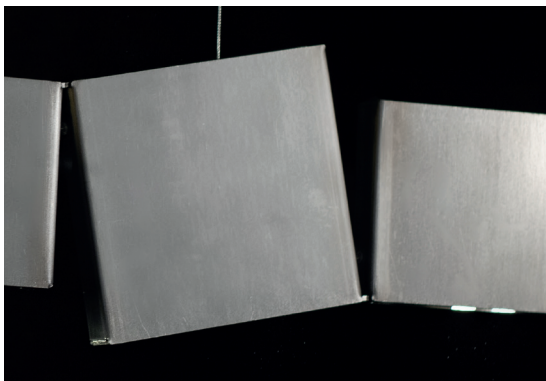
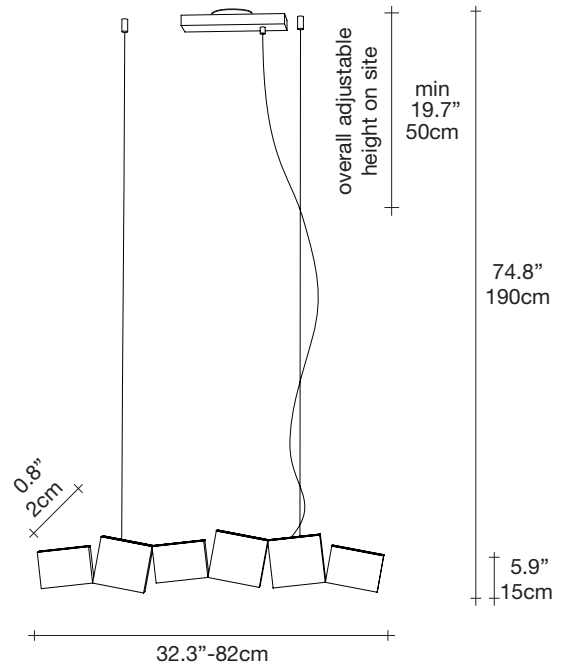

Light source

120V ~ 50/60Hz

-  Built in Replaceable LED Module
12 x 1.5W 2160 lm 3000K
or optional 2700K
- dimmmable with
-  1-10V
PUSH

Canopy

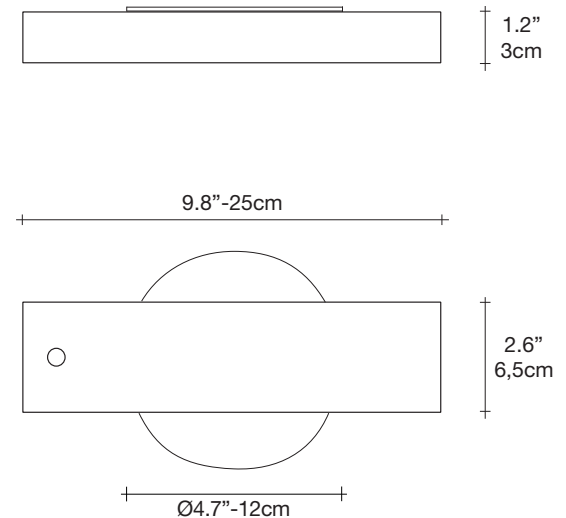

In Greek mythology, Gaia is the personification of the Earth and the mother of all life. Looking to capture the mythical and natural beauty of this Earth goddess, designer Jean-François Crochet has created the Gaia pendant light. Consisting of geometric frames of brass or steel reminiscent of the mountains Gaia created, the pendant uses led light to push light through the "cracks" formed. The resulting light creates a magical feeling, as if the lights peaking through were alive themselves. Available to custom configurations, Gaia adds a vibrancy and sacred light to any space.