

# FLEX NEON LRF5 BENDS LEFT/RIGHT 0.5" FLAT LENS

24VDC OUTDOOR / INDOOR STATIC WHITE, WARM DIM & TUNABLE WHITE

ASSEMBLED IN AMERICA

REV 11.14.22

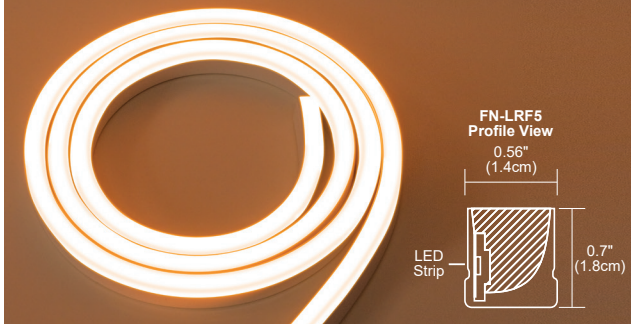

## DESCRIPTION

LRF5 Flexible Neon Bends Left or Right with a 0.5" wide Flat lens, offering superior color rendering while creating uniform illumination without visible dots. May be surface mounted or Flush mounted. Choose from 9 different color temperatures ranging from 2000K to 3500K, including two Warm Dim options of 2400K (24D) or 2700K (27D) and Tunable White (2K6K). Available Tunable White technology grants independent control for adjusting LED color temperature and brightness. Use with two dimmers or, our proprietary Tunable White Controller (CDMX-1) for fast and accurate adjustment with three pre-set scenes (Ordered separately). The (W) is an IP67 rated wet location fixture featuring watertight barrel connections. Seamless (S) for seamless continuous runs, is rated for Indoor Damp Locations ONLY and uses Class 2 bare wire connectors. Patent pending.

## SPECIFICATIONS

Flat top view 0.56" wide 0.7" high

|                       |  |
|-----------------------|--|
| INPUT                 | 24VDC with 5" leads  |
| POWER SUPPLIES        | Remote 24VDC power supply required   |
| POWER CONSUMPTION     | 2.5 or 4.4 watts per foot  |
| INCREMENTS            | 2.4" or 3"   |
| MAX LENGTH            | 40' at 2 watts, 20' at 5 watts   |
| BENDING               | 4" Minimum Radius  |
| MATERIAL              | UV Resistant PVC   |
| OPERATING TEMPERATURE | -4° F (-20° C) to 122° F (+50° C)  |
| AVERAGE LED LIFE      | 50,000 hrs   |
| WARRANTY              | 5 Year pro-rated   |
| COMPLIANCE            | Class 2 Wiring Indoor Applications, Outdoor Wet Location with Water Tight Barrel Connectors IP67 Rated, ETL listed |

## LUMEN PERFORMANCE AT 3000K 5W PER FOOT (SEE COMPLETE CHART PG 2)

|              |           |                |            |
|--------------|-----------|----------------|------------|
| LUMEN OUTPUT | 232 lm/ft | EFFICIENCY     | 50 lm/watt |
| CRI          | 92        | R9             | 76         |
| BEAM ANGLE   | 120°      | BEAM TOLERANCE | +/- 30CCT  |



## REMOTE POWER SUPPLIES\*, DIMMERS & CONTROLS (SOLD SEPARATELY)

24VDC, Class 2 wiring

### OUTDOOR/WET LOCATION

#### Static White & Warm Dim

- [Pure Smart™ WIZ Pro Power Supplies & Controls](#)
- [UNI Driver: Universal Dimming \(TRIAC, ELV, 0-10V\)](#)

#### Tunable White

- [Pure Smart™ WIZ Pro Power Supplies & Controls](#)
- [0-10V](#): Requires two dimmers, one for intensity and one for color temperature
- [DMX Dynamic Color Changing](#): Must be used with PureEdge [Controllers](#)

### INDOOR

#### Static White & Warm Dim

- [Pure Smart™ WIZ Pro Power Supplies & Controls](#)
- [UNI Driver: Universal Dimming \(TRIAC, ELV, 0-10V\)](#)

#### Tunable White

- [Pure Smart™ WIZ Pro Power Supplies & Controls](#)
- [0-10V](#): Requires two dimmers, one for intensity and one for color temperature
- [DMX Dynamic Color Changing](#): Must be used with PureEdge [Controllers](#)

\*In-Wall Mounting and drop ceiling Kits available for select power supplies

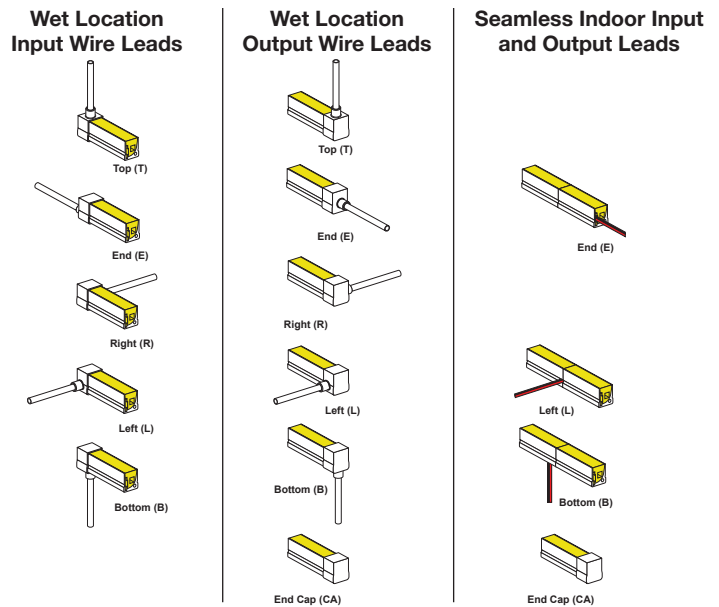

| System           | Viewing Angle Model Shape                              | Wattage                                      | Length in Inches   | Color Temperature   | 5" Input Wire Feed  | 5" Inch Output Wire  | Environment   |
|------------------|--|--|--|---|---|--|---|
| <b>FN</b>        | <b>LRF5</b>  | <b>2W</b>                                    | <b>120</b>   | <b>27K</b>  | <b>E</b>  | <b>L</b>   | <b>W</b>  |
| FN Flex Neon 24V | LRF5 Left or Right side bend Top View Flat 0.5" x 0.7" | 2W 2.5 watts per foot<br>5W 5 watts per foot | 6-480 (40' max)<br>6-240 (20' max)<br><br>*Static & Tunable White:<br>2.4" Increments<br>Warm Dim: 3" increments | 24K 2400K Very Warm White<br>24D* 2400K Warm Dim, Dims to 1800K<br>27K 2700K Incandescent White<br><br>27D* 2700K Warm Dim, Dims to 2000K<br>30K 3000K Warm White<br>35K 3500K Neutral White<br>2K6K* Tunable White 2000K-6500K | T Top Power Input Wire<br>E* End Power Input Wire<br>L* Left Power Input Wire<br>R Right Power Input Wire<br>B* Bottom Power Input Wire | T Top Wire Lead Out<br>E* End Wire Lead Out<br>L* Left Wire Lead Out<br>R Right Wire Lead Out<br>B* Bottom Wire Lead Out<br>CA Cap at end, no feed through | S Seamless Indoor/ Damp location bare wire leads Bottom and Left Feed Only<br>W Outdoor wet location Barrel Connector cable leads |

|         |              |      |
|---------|--------------|------|
| PROJECT | FIXTURE TYPE | DATE |
|---------|--------------|------|

# FLEX NEON LRF5 BENDS LEFT/RIGHT 0.5" FLAT LENS

24VDC OUTDOOR / INDOOR STATIC WHITE, WARM DIM & TUNABLE WHITE

REV 11.14.22

## Lamp Data: Lamp Data for Flex Neon

| WATTS PER FOOT          |     |     |     |     |     |     |     |     |     |     |     |     |
|-------------------------|-----|-----|-----|-----|-----|-----|-----|-----|-----|-----|-----|-----|
| COLOR TEMPERATURE       | 22K | 24K | 27K | 30K | 40K | 22K | 24K | 24D | 27K | 27D | 30K | 35K |
| LUMENS PER FOOT (lm/ft) | 108 | 118 | 147 | 162 | 167 | 195 | 206 | 304 | 237 | 304 | 260 | 297 |
| LUMENS PER WATT (lm/w)  | 39  | 42  | 52  | 58  | 61  | 38  | 42  | 56  | 46  | 56  | 50  | 58  |
| CRI                     | 92  | 92  | 94  | 92  | 84  | 92  | 92  | 93  | 92  | 93  | 84  | 85  |

| 2K6K*                   |     |     |     |     |     |     |     |     |  |
|-------------------------|-----|-----|-----|-----|-----|-----|-----|-----|--|
| 5w                      |     |     |     |     |     |     |     |     |  |
| COLOR TEMPERATURE       | 20K | 24K | 27K | 30K | 35K | 40K | 57K | 65K |  |
| LUMENS PER FOOT (lm/ft) | 176 | 196 | 188 | 195 | 203 | 211 | 198 | 202 |  |
| LUMENS PER WATT (lm/w)  | 34  | 38  | 42  | 43  | 44  | 44  | 44  | 45  |  |
| CRI                     | 92  | 92  | 93  | 92  | 92  | 84  | 84  | 85  |  |

\*Tunable White has a variance in color temperature due to the curvature of the material.

## Drawings: Dimensions for the Flex Neon LRF5

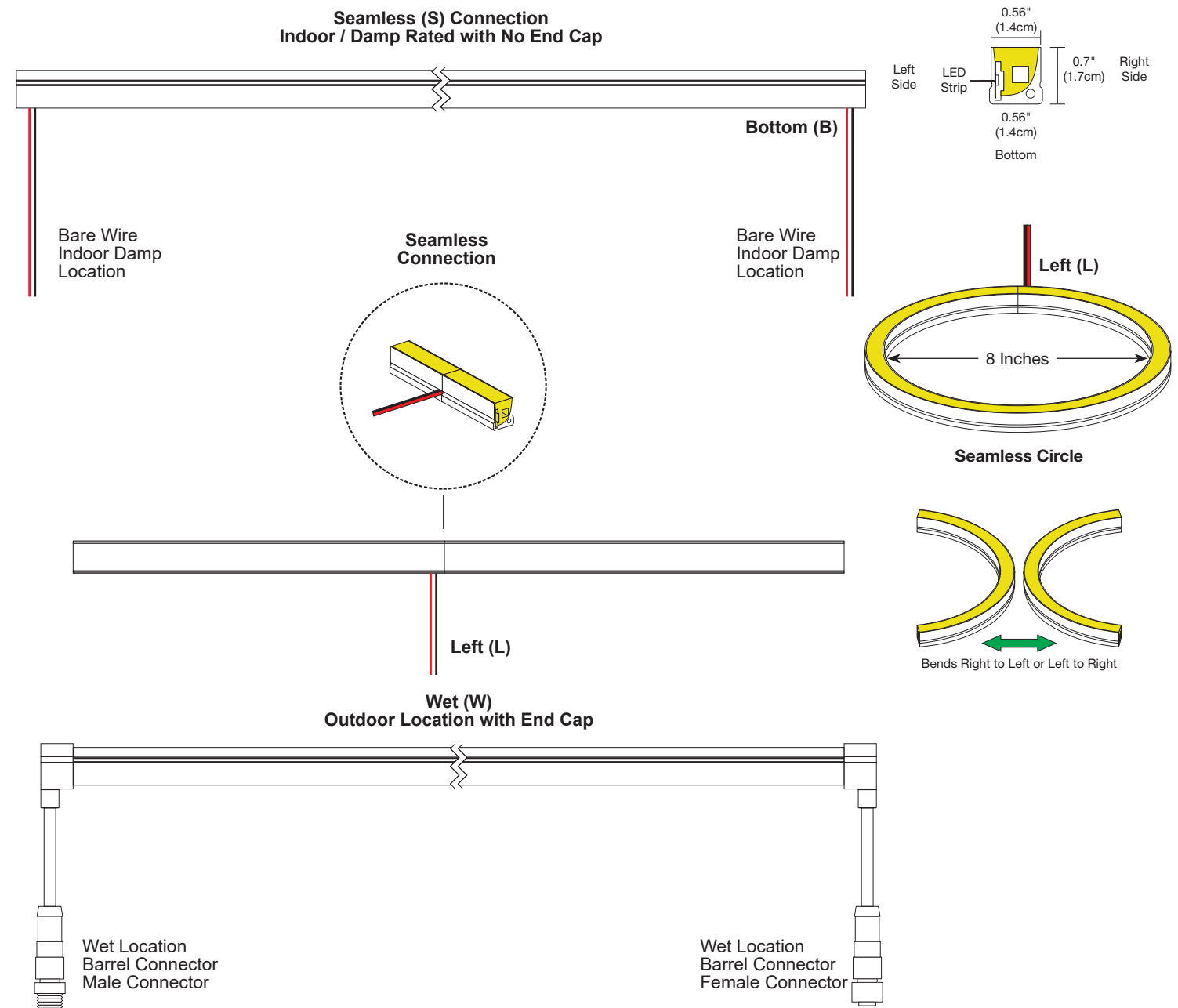

|         |              |      |
|---------|--------------|------|
| PROJECT | FIXTURE TYPE | DATE |
|---------|--------------|------|

# FLEX NEON LRF5 BENDS LEFT/RIGHT 0.5" FLAT LENS

24VDC OUTDOOR / INDOOR STATIC WHITE, WARM DIM & TUNABLE WHITE

**Drawings:** Exploded View for Flexible Aluminum Channel with 1RE J-box

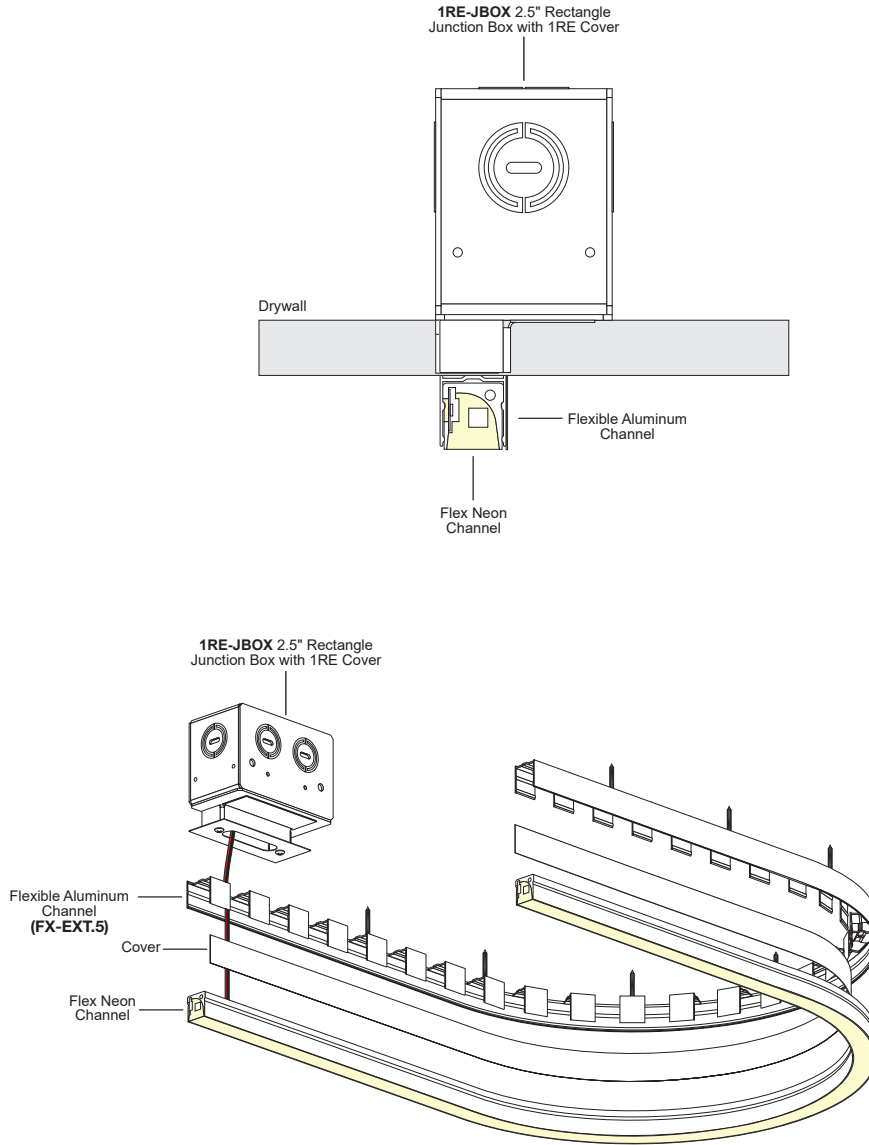

|         |              |      |
|---------|--------------|------|
| PROJECT | FIXTURE TYPE | DATE |
|---------|--------------|------|

# FLEX NEON LRF5 BENDS LEFT/RIGHT 0.5" FLAT LENS

24VDC OUTDOOR / INDOOR STATIC WHITE, WARM DIM & TUNABLE WHITE

## LENGTH CHART Actual lengths for Flex Neon LRF5

### LENGTH CHART - STATIC WHITE

| Ordering Code (Nominal Size) | Actual Length | Ordering Code (Nominal Size) | Actual Length | Ordering Code (Nominal Size) | Actual Length | Ordering Code (Nominal Size) | Actual Length | Ordering Code (Nominal Size) | Actual Length | Ordering Code (Nominal Size) | Actual Length | Ordering Code (Nominal Size) | Actual Length |
|------------------------------|---------------|------------------------------|---------------|------------------------------|---------------|------------------------------|---------------|------------------------------|---------------|------------------------------|---------------|------------------------------|---------------|
| 3                            | 3.15          | 72                           | 72.75         | 142                          | 142.35        | 212                          | 211.95        | 281                          | 281.55        | 348                          | 348.75        | 416                          | 415.95        |
| 5                            | 5.55          | 75                           | 75.15         | 144                          | 144.75        | 214                          | 214.35        | 284                          | 283.95        | 351                          | 351.15        | 418                          | 418.35        |
| 8                            | 7.95          | 77                           | 77.55         | 147                          | 147.15        | 216                          | 216.75        | 286                          | 286.35        | 353                          | 353.55        | 420                          | 420.75        |
| 10                           | 10.35         | 80                           | 79.95         | 149                          | 149.55        | 219                          | 219.15        | 288                          | 288.75        | 356                          | 355.95        | 423                          | 423.15        |
| 12                           | 12.75         | 82                           | 82.35         | 152                          | 151.95        | 221                          | 221.55        | 291                          | 291.15        | 358                          | 358.35        | 425                          | 425.55        |
| 15                           | 15.15         | 84                           | 84.75         | 154                          | 154.35        | 224                          | 223.95        | 293                          | 293.55        | 360                          | 360.75        | 428                          | 427.95        |
| 17                           | 17.55         | 87                           | 87.15         | 156                          | 156.75        | 226                          | 226.35        | 296                          | 295.95        | 363                          | 363.15        | 430                          | 430.35        |
| 20                           | 19.95         | 89                           | 89.55         | 159                          | 159.15        | 228                          | 228.75        | 298                          | 298.35        | 365                          | 365.55        | 432                          | 432.75        |
| 22                           | 22.35         | 92                           | 91.95         | 161                          | 161.55        | 231                          | 231.15        | 300                          | 300.75        | 368                          | 367.95        | 435                          | 435.15        |
| 24                           | 24.75         | 94                           | 94.35         | 164                          | 163.95        | 233                          | 233.55        | 303                          | 303.15        | 370                          | 370.35        | 437                          | 437.55        |
| 27                           | 27.15         | 96                           | 96.75         | 166                          | 166.35        | 236                          | 235.95        | 305                          | 305.55        | 372                          | 372.75        | 440                          | 439.95        |
| 29                           | 29.55         | 99                           | 99.15         | 168                          | 168.75        | 238                          | 238.35        | 308                          | 307.95        | 375                          | 375.15        | 442                          | 442.35        |
| 32                           | 31.95         | 101                          | 101.55        | 171                          | 171.15        | 240                          | 240.75        | 310                          | 310.35        | 377                          | 377.55        | 444                          | 444.75        |
| 34                           | 34.35         | 104                          | 103.95        | 173                          | 173.55        | 243                          | 243.15        | 312                          | 312.75        | 380                          | 379.95        | 447                          | 447.15        |
| 36                           | 36.75         | 106                          | 106.35        | 176                          | 175.95        | 245                          | 245.55        | 315                          | 315.15        | 382                          | 382.35        | 449                          | 449.55        |
| 39                           | 39.15         | 108                          | 108.75        | 178                          | 178.35        | 248                          | 247.95        | 317                          | 317.55        | 384                          | 384.75        | 452                          | 451.95        |
| 41                           | 41.55         | 111                          | 111.15        | 180                          | 180.75        | 250                          | 250.35        | 320                          | 319.95        | 387                          | 387.15        | 454                          | 454.35        |
| 44                           | 43.95         | 113                          | 113.55        | 183                          | 183.15        | 252                          | 252.75        | 322                          | 322.35        | 389                          | 389.55        | 456                          | 456.75        |
| 46                           | 46.35         | 116                          | 115.95        | 185                          | 185.55        | 255                          | 255.15        | 324                          | 324.75        | 392                          | 391.95        | 459                          | 459.15        |
| 48                           | 48.75         | 118                          | 118.35        | 188                          | 187.95        | 257                          | 257.55        | 327                          | 327.15        | 394                          | 394.35        | 461                          | 461.55        |
| 51                           | 51.15         | 120                          | 120.75        | 190                          | 190.35        | 260                          | 259.95        | 329                          | 329.55        | 396                          | 396.75        | 464                          | 463.95        |
| 53                           | 53.55         | 123                          | 123.15        | 192                          | 192.75        | 262                          | 262.35        | 332                          | 331.95        | 399                          | 399.15        | 466                          | 466.35        |
| 56                           | 55.95         | 125                          | 125.55        | 195                          | 195.15        | 264                          | 264.75        | 334                          | 334.35        | 401                          | 401.55        | 468                          | 468.75        |
| 58                           | 58.35         | 128                          | 127.95        | 197                          | 197.55        | 267                          | 267.15        | 336                          | 336.75        | 404                          | 403.95        | 471                          | 471.15        |
| 60                           | 60.75         | 130                          | 130.35        | 200                          | 199.95        | 269                          | 269.55        | 339                          | 339.15        | 406                          | 406.35        | 473                          | 473.55        |
| 63                           | 63.15         | 132                          | 132.75        | 202                          | 202.35        | 272                          | 271.95        | 341                          | 341.55        | 408                          | 408.75        | 476                          | 475.95        |
| 65                           | 65.55         | 135                          | 135.15        | 204                          | 204.75        | 274                          | 274.35        | 344                          | 343.95        | 411                          | 411.15        | 478                          | 478.35        |
| 68                           | 67.95         | 137                          | 137.55        | 207                          | 207.15        | 276                          | 276.75        | 346                          | 346.35        | 413                          | 413.55        | 480                          | 480.75        |
| 70                           | 70.35         | 140                          | 139.95        | 209                          | 209.55        | 279                          | 279.15        |                              |               |                              |               |                              |               |

### LENGTH CHART - WARM DIM

| Ordering Code (Nominal Size) | Actual Length | Ordering Code (Nominal Size) | Actual Length | Ordering Code (Nominal Size) | Actual Length | Ordering Code (Nominal Size) | Actual Length | Ordering Code (Nominal Size) | Actual Length | Ordering Code (Nominal Size) | Actual Length | Ordering Code (Nominal Size) | Actual Length |
|------------------------------|---------------|------------------------------|---------------|------------------------------|---------------|------------------------------|---------------|------------------------------|---------------|------------------------------|---------------|------------------------------|---------------|
| 3                            | 3.75          | 75                           | 75.75         | 138                          | 138.75        | 207                          | 207.75        | 276                          | 276.75        | 345                          | 345.75        | 414                          | 414.75        |
| 6                            | 6.75          | 78                           | 78.75         | 141                          | 141.75        | 210                          | 210.75        | 279                          | 279.75        | 348                          | 348.75        | 417                          | 417.75        |
| 9                            | 9.75          | 81                           | 81.75         | 144                          | 144.75        | 213                          | 213.75        | 282                          | 282.75        | 351                          | 351.75        | 420                          | 420.75        |
| 12                           | 12.75         | 84                           | 83.75         | 147                          | 147.75        | 216                          | 216.75        | 285                          | 285.75        | 354                          | 354.75        | 423                          | 423.75        |
| 15                           | 15.75         | 87                           | 86.75         | 150                          | 150.75        | 219                          | 219.75        | 288                          | 288.75        | 357                          | 357.75        | 426                          | 426.75        |
| 18                           | 18.75         | 90                           | 89.75         | 153                          | 153.75        | 222                          | 222.75        | 291                          | 291.75        | 360                          | 360.75        | 429                          | 429.75        |
| 21                           | 21.75         | 93                           | 92.75         | 156                          | 156.75        | 225                          | 225.75        | 294                          | 294.75        | 363                          | 363.75        | 432                          | 432.75        |
| 24                           | 24.75         | 96                           | 95.75         | 159                          | 159.75        | 228                          | 228.75        | 297                          | 297.75        | 366                          | 366.75        | 435                          | 435.75        |
| 27                           | 27.75         | 99                           | 98.75         | 162                          | 162.75        | 231                          | 231.75        | 300                          | 300.75        | 369                          | 369.75        | 438                          | 438.75        |
| 30                           | 30.75         | 102                          | 101.75        | 165                          | 165.75        | 234                          | 234.75        | 303                          | 303.75        | 372                          | 372.75        | 441                          | 441.75        |
| 33                           | 33.75         | 105                          | 104.75        | 168                          | 168.75        | 237                          | 237.75        | 306                          | 306.75        | 375                          | 375.75        | 444                          | 444.75        |
| 36                           | 36.75         | 108                          | 107.75        | 171                          | 171.75        | 240                          | 240.75        | 309                          | 309.75        | 378                          | 378.75        | 447                          | 447.75        |
| 39                           | 39.75         | 111                          | 110.75        | 174                          | 174.75        | 243                          | 243.75        | 312                          | 312.75        | 381                          | 381.75        | 450                          | 450.75        |
| 42                           | 42.75         | 114                          | 113.75        | 177                          | 177.75        | 246                          | 246.75        | 315                          | 315.75        | 384                          | 384.75        | 453                          | 453.75        |
| 45                           | 45.75         | 117                          | 116.75        | 180                          | 180.75        | 249                          | 249.75        | 318                          | 318.75        | 387                          | 387.75        | 456                          | 456.75        |
| 48                           | 48.75         | 120                          | 119.75        | 183                          | 183.75        | 252                          | 252.75        | 321                          | 321.75        | 390                          | 390.75        | 459                          | 459.75        |
| 51                           | 51.75         | 123                          | 122.75        | 186                          | 186.75        | 255                          | 255.75        | 324                          | 324.75        | 393                          | 393.75        | 462                          | 462.75        |
| 54                           | 54.75         | 126                          | 125.75        | 189                          | 189.75        | 258                          | 258.75        | 327                          | 327.75        | 396                          | 396.75        | 465                          | 465.75        |
| 57                           | 57.75         | 129                          | 128.75        | 192                          | 192.75        | 261                          | 261.75        | 330                          | 330.75        | 399                          | 399.75        | 468                          | 468.75        |
| 60                           | 60.75         | 132                          | 131.75        | 195                          | 195.75        | 264                          | 264.75        | 333                          | 333.75        | 402                          | 402.75        | 471                          | 471.75        |
| 63                           | 63.75         | 135                          | 133.75        | 198                          | 198.75        | 267                          | 267.75        | 336                          | 336.75        | 405                          | 405.75        | 474                          | 474.75        |
| 66                           | 66.75         |                              |               | 201                          | 201.75        | 270                          | 270.75        | 339                          | 339.75        | 408                          | 408.75        | 477                          | 477.75        |
| 69                           | 69.75         |                              |               | 204                          | 204.75        | 273                          | 273.75        | 342                          | 342.75        | 411                          | 411.75        | 480                          | 480.75        |
| 72                           | 72.75         |                              |               |                              |               |                              |               |                              |               |                              |               |                              |               |

|         |  |              |  |      |  |
|---------|--|--------------|--|------|--|
| PROJECT |  | FIXTURE TYPE |  | DATE |  |
|---------|--|--------------|--|------|--|

# FLEX NEON LRF5 BENDS LEFT/RIGHT 0.5" FLAT LENS

24VDC OUTDOOR / INDOOR STATIC WHITE, WARM DIM & TUNABLE WHITE

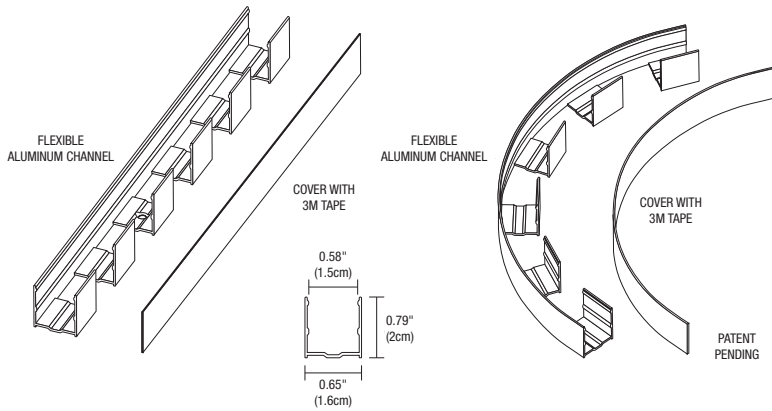

## FLEXIBLE ALUMINUM CHANNEL

Flexible aluminum channel is designed to work specifically with Flex Neon for practical and professional mounting. The channel can make large radius 90° turns and sweeping bends that follow the form of architectural details, soffits, signage and more - consider using this channel to guide your linear LED lighting design. Patent Pending.

| Product                               | Length     | Finish               |
|---------------------------------------|------------|----------------------|
| <b>FX-EXT.5</b>                       | <b>4FT</b> | <b>WH</b>            |
| FX-EXT.5 Flexible Extrusion 0.5" Wide | 4FT 4 Feet | BK Black<br>WH White |

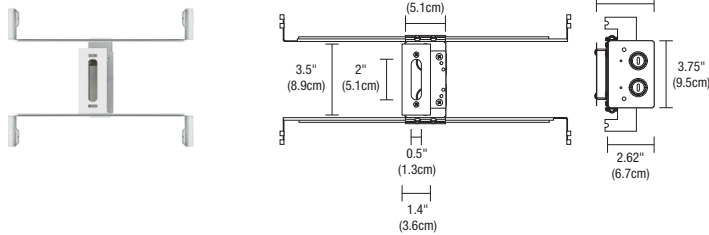

## 1" RECTANGLE CANOPY & J-BOX\*

The Slim-Profile Junction Box with Hanger Bars mounts to studs spaced between 14.5" and 25" apart behind drywall. Allows low voltage DC wires from Remote Power Supply to connect to channel wires. The Junction Box opening is covered by the fixture for a clean, safe connection. Includes a Goof Plate, for poor plastering around J-box.

\*Only to be used with Seamless Indoor Bottom Lead-In and Out

| Canopy           | Product           |
|------------------|-------------------|
| <b>1RE</b>       | <b>JBOX</b>       |
| 1RE 1" Rectangle | JBOX Junction Box |

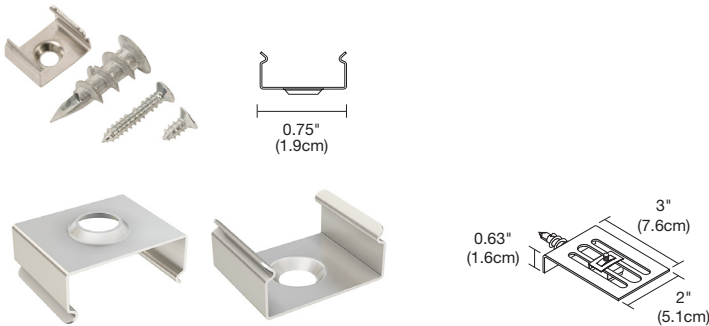

## MOUNTING CLIPS

NX.5-MCL mounting clips are provided with every 12" of Flex Neon and may be ordered separately as replacement parts.

| System                           | Product           |
|----------------------------------|-------------------|
| <b>NX.5</b>                      | <b>MCL</b>        |
| NX.5 Flex Neon .5" Mounting Clip | MCL Mounting Clip |

|         |              |      |
|---------|--------------|------|
| PROJECT | FIXTURE TYPE | DATE |
|---------|--------------|------|

# FLEX NEON LRF5 BENDS LEFT/RIGHT 0.5" FLAT LENS

24VDC OUTDOOR / INDOOR STATIC WHITE, WARM DIM & TUNABLE WHITE

## FLEX NEON TIE STRAP

Use for mounting to poles for extra support, every 6"-12" (30 per package).



| Product          | Type         |
|------------------|--------------|
| <b>SS</b>        | <b>ST</b>    |
| SS LED Flex Neon | ST Tie Strap |

## DIRECT BURIAL LOCATION CABLE ORDER PER FOOT

Our Direct Burial, 2 Conductor Plus ground, 12 Gauge Cable is a durable and adaptable cable suitable for transmitting power, control, and switching in outdoor wet and in ground environments. Keep within 60 ft between fixture and power supply. Cable sold by the foot, simply specify the length needed by the foot.



| Product          | Gauge        | Cable          |
|------------------|--------------|----------------|
| <b>DB</b>        | <b>12G</b>   | <b>2C</b>      |
| DB Direct Burial | 12G 12 Gauge | 2C 2 Conductor |

## WET AND DAMP LOCATION CABLE ORDER PER FOOT

Our Wet Location, 5 Conductor, 14 Gauge Cable is a durable and adaptable cable suitable for transmitting power, control, and switching in indoor and outdoor wet and damp environments. Cable sold by the foot, simply specify the length needed by the foot. Keep within 50 ft between fixture and power supply. Cable sold by the foot, simply specify the length needed by the foot.

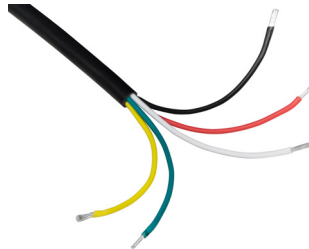

| Product          | Gauge        | Cable          |
|------------------|--------------|----------------|
| <b>OC</b>        | <b>14G</b>   | <b>5C</b>      |
| OC Outdoor Cable | 14G 14 Gauge | 5C 5 Conductor |

|         |              |      |
|---------|--------------|------|
| PROJECT | FIXTURE TYPE | DATE |
|---------|--------------|------|

# FLEX NEON LRF5 BENDS LEFT/RIGHT 0.5" FLAT LENS

24VDC OUTDOOR / INDOOR STATIC WHITE, WARM DIM & TUNABLE WHITE

## WET LOCATION JUNCTION BOX

Wet-rated low voltage Splice Box with connectors.

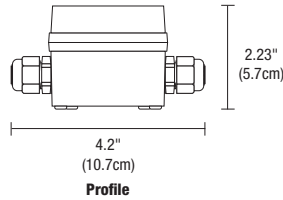
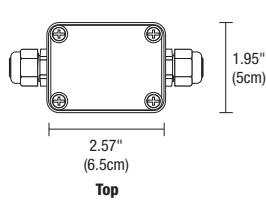

| Product          | Type              | Option         |
|------------------|-------------------|----------------|
| <b>2RE</b>       | <b>JBOX</b>       | <b>W</b>       |
| 2RE 2" Rectangle | JBOX Junction Box | W Wet Location |

## WET LOCATION JUNCTION BOX WITH 6" POWER CABLE

This watertight, multi-fixture Junction Box is especially designed for lighting in wet and damp locations. It is versatile, rugged and simple to install. The Junction Box comes standard with a 6" Flexible Cable providing easy, safe, and reliable connections for 24V low voltage luminaires. This box is approved for indoor and outdoor usage and complies with all the requirements of UL1241 and the National Electric Code.



| Product                     | Canopy           | Product           | Size                        | Option         |
|-----------------------------|------------------|-------------------|-----------------------------|----------------|
| <b>SS</b>                   | <b>2RE</b>       | <b>JBOX</b>       | <b>6IN</b>                  | <b>W</b>       |
| SS LED Soft Strip Flex Neon | 2RE 2" Rectangle | JBOX Junction Box | 6IN 6" Four Wire Connection | W Wet Location |

## POWER CABLE CONNECTOR WET LOCATION

The flexible power cable connector is designed to work in outdoor environments for safe and reliable connections. This Flexible Connector is easy to install and configure, helping you create innovative lighting designs in an outdoor commercial or residential space.

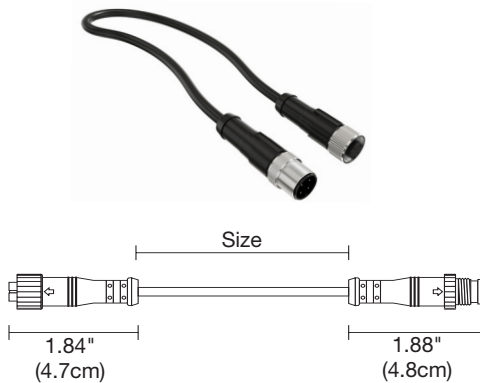

| Product                     | Type                          | Size                 | Option         |
|-----------------------------|-------------------------------|----------------------|----------------|
| <b>SS</b>                   | <b>CFX</b>                    | <b>12IN</b>          | <b>W</b>       |
| SS Soft Strip and Flex Neon | CFX Flexible 4 Wire Connector | 12IN 12"<br>96IN 96" | W Wet Location |

## WET LOCATION T-CONNECTOR

Our Wet Location T-Connector is a robust rugged design especially suited to withstand the challenges of damp and wet environments. This unique T-Connector has one Male and two Female Connectors and is suitable for multiple indoor and outdoor uses. Versatile design is easy to use, making installation quick and efficient.



| Product                     | Type                  | Option         |
|-----------------------------|-----------------------|----------------|
| <b>SS</b>                   | <b>TC</b>             | <b>W</b>       |
| SS Soft Strip and Flex Neon | TC T-Connector 4 Wire | W Wet Location |

|         |              |      |
|---------|--------------|------|
| PROJECT | FIXTURE TYPE | DATE |
|---------|--------------|------|

# LED STRIP TM30 DATA

24VDC, STATIC WHITE, WARM DIM & DYNAMIC/TUNABLE WHITE

**TM-30-15 DATA:** The data below is for ST2A, ST5A, ST7A and ST10A bare LED Soft Strips. Consistent color temperatures throughout a single strip and among multiple strips is possible through a 3 phase binning process in which each order is inspected with a color meter to ensure uniformity.

**2200K** | Rf: 90.5 | Rg: 99.9

Color Vector Graphic

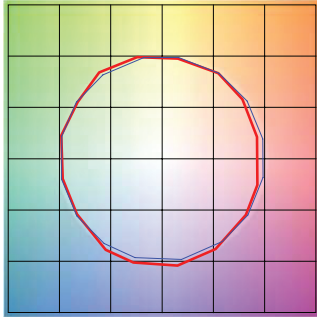

■ Test ■ Reference

| GRAPHIC SHIFTS % |      |        |        |
|------------------|------|--------|--------|
| HUE BIN          | Rf   | CHROMA | HUE    |
| 1                | 88.3 | -5.2%  | 1.0%   |
| 2                | 90.1 | -3.6%  | 3.7%   |
| 3                | 87.5 | -0.5%  | 5.6%   |
| 4                | 93.9 | -1.2%  | 1.3%   |
| 5                | 94.7 | 0.7%   | 2.1%   |
| 6                | 93.7 | 2.6%   | 0.7%   |
| 7                | 93.5 | -1.5%  | -2.2%  |
| 8                | 97.8 | -0.4%  | -0.2%  |
| 9                | 93.7 | -1.5%  | 2.4%   |
| 10               | 90.8 | -0.8%  | 4.9%   |
| 11               | 89.3 | 3.7%   | 5.4%   |
| 12               | 90.2 | 4.6%   | 1.0%   |
| 13               | 89.0 | 4.4%   | -9.7%  |
| 14               | 75.4 | 0.6%   | -15.1% |
| 15               | 90.7 | -1.7%  | -5.0%  |
| 16               | 84.2 | -4.4%  | -9.1%  |

**2400K** | Rf: 90.2 | Rg: 99.3

Color Vector Graphic

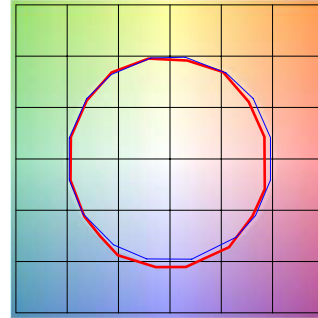

■ Test ■ Reference

| GRAPHIC SHIFTS % |      |        |        |
|------------------|------|--------|--------|
| HUE BIN          | Rf   | CHROMA | HUE    |
| 1                | 89.0 | -4.8%  | 1.1%   |
| 2                | 90.4 | -3.7%  | 3.2%   |
| 3                | 88.1 | -0.7%  | 5.2%   |
| 4                | 93.0 | -2.1%  | 0.9%   |
| 5                | 94.5 | -0.1%  | 2.0%   |
| 6                | 94.7 | 1.7%   | 0.6%   |
| 7                | 93.7 | -1.9%  | -1.5%  |
| 8                | 96.8 | -1.2%  | 0.2%   |
| 9                | 91.9 | -1.8%  | 3.7%   |
| 10               | 88.8 | -0.9%  | 6.1%   |
| 11               | 87.5 | 3.8%   | 7.1%   |
| 12               | 89.6 | 4.3%   | 0.3%   |
| 13               | 88.1 | 4.2%   | -9.1%  |
| 14               | 82.5 | 2.8%   | -10.6% |
| 15               | 91.4 | -2.1%  | -4.2%  |
| 16               | 84.0 | -3.6%  | -9.9%  |

**2700K** | Rf: 89.5 | Rg: 98.3

Color Vector Graphic

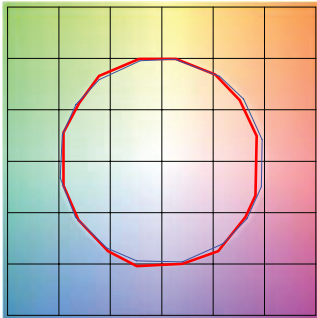

■ Test ■ Reference

| GRAPHIC SHIFTS % |      |        |        |
|------------------|------|--------|--------|
| HUE BIN          | Rf   | CHROMA | HUE    |
| 1                | 88.6 | -5.2%  | 0.9%   |
| 2                | 90.3 | -3.6%  | 2.9%   |
| 3                | 88.4 | -1.5%  | 5.0%   |
| 4                | 91.9 | -2.5%  | 1.4%   |
| 5                | 93.5 | -0.9%  | 2.3%   |
| 6                | 95.7 | 0.9%   | -0.4%  |
| 7                | 91.1 | -3.7%  | -0.5%  |
| 8                | 95.8 | -2.0%  | 0.4%   |
| 9                | 90.5 | -2.6%  | 4.5%   |
| 10               | 84.9 | -1.1%  | 8.7%   |
| 11               | 85.0 | 2.3%   | 9.8%   |
| 12               | 88.1 | 5.5%   | 1.5%   |
| 13               | 90.9 | 2.9%   | -5.2%  |
| 14               | 86.2 | 4.3%   | -8.9%  |
| 15               | 90.7 | -2.4%  | -3.6%  |
| 16               | 83.0 | -2.7%  | -11.3% |

**3000K** | Rf: 88.7 | Rg: 98.2

Color Vector Graphic

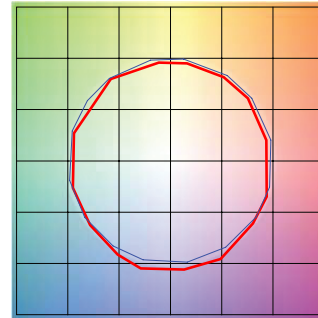

■ Test ■ Reference

| GRAPHIC SHIFTS % |      |        |        |
|------------------|------|--------|--------|
| HUE BIN          | Rf   | CHROMA | HUE    |
| 1                | 88.3 | -5.2%  | 0.8%   |
| 2                | 90.2 | -3.7%  | 2.7%   |
| 3                | 88.3 | -1.6%  | 4.9%   |
| 4                | 92.2 | -2.0%  | 1.8%   |
| 5                | 91.0 | -3.5%  | 1.8%   |
| 6                | 95.8 | 0.4%   | -0.4%  |
| 7                | 90.2 | -4.4%  | -0.0%  |
| 8                | 94.8 | -2.6%  | 0.8%   |
| 9                | 89.2 | -2.9%  | 6.0%   |
| 10               | 81.4 | -1.5%  | 9.7%   |
| 11               | 82.9 | 2.3%   | 10.5%  |
| 12               | 88.3 | 6.7%   | 1.9%   |
| 13               | 91.9 | 2.8%   | -4.0%  |
| 14               | 86.3 | 4.9%   | -8.3%  |
| 15               | 87.1 | -1.2%  | -6.1%  |
| 16               | 83.2 | -1.7%  | -11.6% |

**3500K** | Rf: 88.1 | Rg: 97.1

Color Vector Graphic

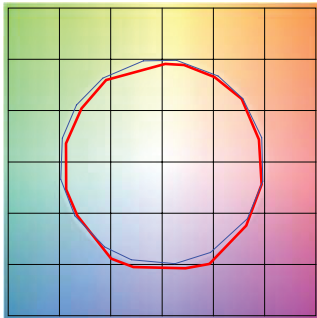

■ Test ■ Reference

| GRAPHIC SHIFTS % |      |        |       |
|------------------|------|--------|-------|
| HUE BIN          | Rf   | CHROMA | HUE   |
| 1                | 87.8 | -5.2%  | 1.0%  |
| 2                | 90.8 | -3.3%  | 2.3%  |
| 3                | 89.8 | -1.6%  | 3.9%  |
| 4                | 91.0 | -2.7%  | 0.9%  |
| 5                | 90.0 | -5.4%  | 0.7%  |
| 6                | 95.6 | -0.9%  | -0.4% |
| 7                | 90.0 | -5.3%  | 1.4%  |
| 8                | 91.8 | -3.6%  | 3.0%  |
| 9                | 87.1 | -2.9%  | 7.3%  |
| 10               | 80.1 | -1.3%  | 12.2% |
| 11               | 81.8 | 4.1%   | 10.5% |
| 12               | 88.2 | 5.1%   | 2.3%  |
| 13               | 92.4 | 2.1%   | -3.8% |
| 14               | 86.6 | 5.0%   | -7.9% |
| 15               | 86.2 | -0.7%  | -6.8% |
| 16               | 84.5 | -2.1%  | -7.0% |

**5700K** | Rf: 87.6 | Rg: 98.0

Color Vector Graphic

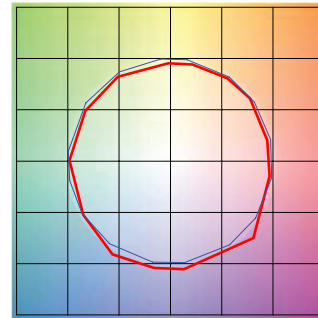

■ Test ■ Reference

| GRAPHIC SHIFTS % |      |        |        |
|------------------|------|--------|--------|
| HUE BIN          | Rf   | CHROMA | HUE    |
| 1                | 87.9 | -3.9%  | 1.5%   |
| 2                | 92.3 | -1.7%  | 2.7%   |
| 3                | 91.0 | -1.2%  | 2.4%   |
| 4                | 91.5 | -1.2%  | 1.6%   |
| 5                | 86.2 | -5.9%  | -0.4%  |
| 6                | 93.5 | -3.2%  | -0.2%  |
| 7                | 93.1 | -3.8%  | 0.6%   |
| 8                | 85.9 | -4.6%  | 5.9%   |
| 9                | 83.6 | -4.0%  | 12.7%  |
| 10               | 75.8 | -0.6%  | 13.6%  |
| 11               | 80.2 | 4.3%   | 10.4%  |
| 12               | 83.4 | 3.4%   | 1.8%   |
| 13               | 90.8 | 5.0%   | -2.0%  |
| 14               | 91.8 | 1.3%   | -3.3%  |
| 15               | 79.4 | 8.6%   | -12.7% |
| 16               | 93.4 | -2.7%  | -0.2%  |

|         |              |      |
|---------|--------------|------|
| PROJECT | FIXTURE TYPE | DATE |
|---------|--------------|------|



# LED STRIP TM30 DATA

24VDC, STATIC WHITE, WARM DIM & DYNAMIC/TUNABLE WHITE

**TM-30-15 DATA:** The data below is for ST2A, ST5A, ST7A and ST10A bare LED Soft Strips. Consistent color temperatures throughout a single strip and among multiple strips is possible through a 3 phase binning process in which each order is inspected with a color meter to ensure uniformity.

**2700D** | Rf: 90.7 | Rg: 101.1

Color Vector Graphic

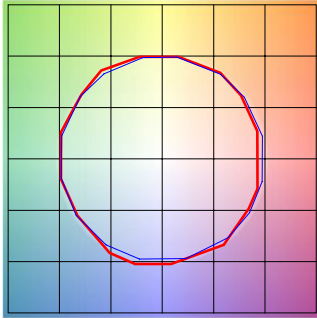

■ Test ■ Reference

| GRAPHIC SHIFTS % |      |        |        |
|------------------|------|--------|--------|
| HUE BIN          | Rf   | CHROMA | HUE    |
| 1                | 90.9 | -4.1%  | 1.1%   |
| 2                | 91.8 | -2.2%  | 3.2%   |
| 3                | 89.0 | 0.2%   | 5.0%   |
| 4                | 92.9 | -1.1%  | 0.8%   |
| 5                | 93.9 | 1.1%   | 1.7%   |
| 6                | 93.3 | 3.3%   | 0.0%   |
| 7                | 93.1 | -0.5%  | -1.9%  |
| 8                | 97.2 | -0.3%  | -0.9%  |
| 9                | 93.4 | -1.0%  | 3.2%   |
| 10               | 89.9 | -0.1%  | 5.6%   |
| 11               | 87.0 | 4.7%   | 7.2%   |
| 12               | 89.2 | 5.8%   | -0.2%  |
| 13               | 89.1 | 3.5%   | -6.7%  |
| 14               | 86.3 | 4.1%   | -9.2%  |
| 15               | 91.4 | -2.0%  | -3.6%  |
| 16               | 84.7 | -2.1%  | -10.3% |

**3000D** | Rf: 90.6 | Rg: 101.1

Color Vector Graphic

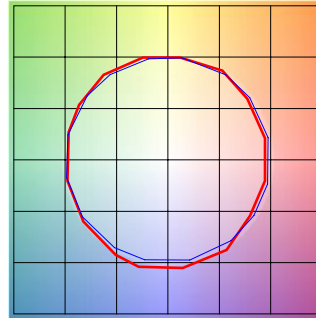

■ Test ■ Reference

| GRAPHIC SHIFTS % |      |        |        |
|------------------|------|--------|--------|
| HUE BIN          | Rf   | CHROMA | HUE    |
| 1                | 91.5 | -3.5%  | 1.3%   |
| 2                | 92.2 | -1.8%  | 3.0%   |
| 3                | 89.3 | 0.5%   | 4.8%   |
| 4                | 92.7 | -1.1%  | 0.6%   |
| 5                | 93.3 | 0.5%   | 1.4%   |
| 6                | 93.8 | 2.7%   | -0.8%  |
| 7                | 91.2 | -2.1%  | -0.2%  |
| 8                | 97.0 | -0.5%  | -0.7%  |
| 9                | 92.5 | -0.7%  | 3.8%   |
| 10               | 88.3 | 0.9%   | 7.1%   |
| 11               | 87.5 | 3.9%   | 7.6%   |
| 12               | 88.2 | 6.2%   | -0.2%  |
| 13               | 89.9 | 3.4%   | -6.0%  |
| 14               | 86.9 | 4.4%   | -8.5%  |
| 15               | 91.9 | -1.9%  | -2.9%  |
| 16               | 84.7 | -1.3%  | -10.6% |

|         |              |      |
|---------|--------------|------|
| PROJECT | FIXTURE TYPE | DATE |
|---------|--------------|------|