



MONORAIL HEADS, PENDANTS AND SUSPENSIONS

12VAC



DESIGNED BY GREGORY KAY | ASSEMBLED IN AMERICA

REV 10.13.22

PISTON

LED, MONORAIL FIXTURE HEAD

DESCRIPTION

Compact yet packed with power, the 12VAC FJ Piston LED is a classic flat-back cylindrical fixture that tilts 90° vertically; 360° horizontally. Using the FJ Fast Jack 12 volt Connector, you can choose to mount this fixture head to a Monorail, 2" or 4" Round MonoPoint Canopies, and MultiPoint Canopies. Its 15°, 25°, 35°, or 45° beam spread TRI Lens gives off a smooth, uniformed beam up to 517 Lumens at 9W/3000K/95CRI.

FINISH & MATERIAL



Satin Nickel **SN**
White **WH**

- Machined from Billet Aluminum
- Tilts 90°
- Rotates 360°

LENS

Field changeable TRI Lens gives a smooth uniform beam at 15°, 25°, 35° or 45° beam spreads

APPLICATIONS

Suitable for damp or dry location, interior use only

LAMP SPECIFICATIONS

9 watt integrated LED chip, up to 517 Lumens, 3000K

DIMMING

- Dimmable to 1% Percent of Flicker <25%
- ELV dimming standard. Compatible with Lutron Diva, Skylark, and Legrand ELV dimmers

WARRANTY / LABELS

Prorated 5 year warranty. Assembled in America
ETL (Conforms to UL1598 and CSA 22.2 #250.0)



LINK TO 3D FILES

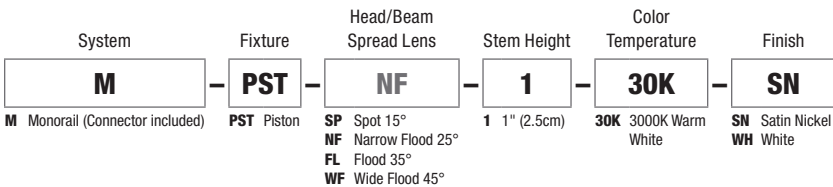

FJ-PST-NF-1-30K-SN
Satin Nickel

FJ-PST-NF-1-30K-WH
White

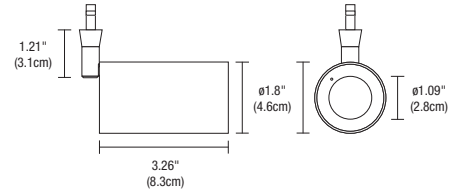

3000K | Rf: 93.2 | Rg: 100.8

Color Vector Graphic

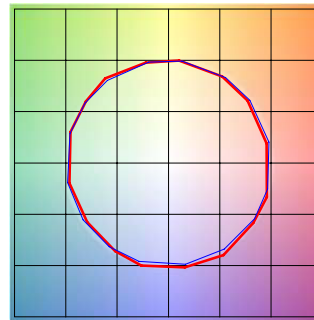

		GRAPHIC SHIFTS %	
HUE BIN	Rf	CHROMA	HUE
1	94.1	-2.5%	0.9%
2	95.4	-2.0%	1.1%
3	92.2	-0.9%	3.4%
4	94.5	0.0%	2.8%
5	94.0	0.1%	2.8%
6	94.9	2.7%	0.5%
7	95.4	0.2%	-1.9%
8	97.5	-0.1%	-1.5%
9	96.0	-1.7%	0.8%
10	91.1	-2.1%	4.0%
11	88.9	0.2%	7.4%
12	90.5	3.5%	3.0%
13	94.4	2.9%	-1.3%
14	91.4	4.5%	-3.9%
15	92.5	1.1%	-4.1%
16	89.0	0.7%	-7.9%

Red Test Blue Reference

BEAM ANGLE 16°

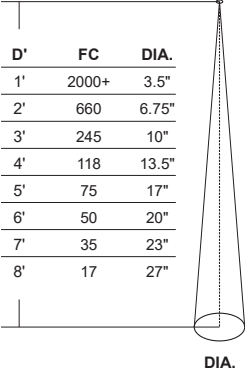

BEAM ANGLE 23°

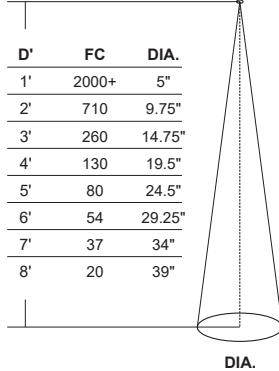

BEAM ANGLE 36°

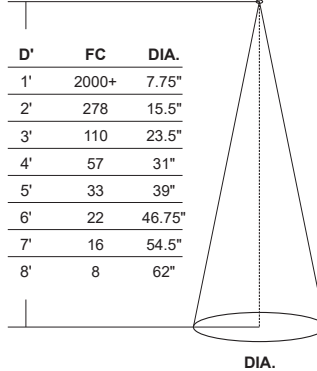

BEAM ANGLE 47°

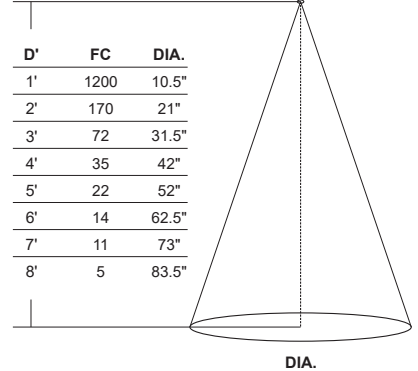

PROJECT	FIXTURE TYPE	DATE
---------	--------------	------

SCOPE

LED, MONORAIL FIXTURE HEAD

DESCRIPTION

The Scope LED, a classic flat-back cylinder fixture, tilts 90° vertically. The cool-to-the-touch rotating lens allows adjustment of the beam angle from 20° spot to 50° flood while the fixture is lit. Fixture includes 5 year warranty.

FINISH & MATERIAL



Satin Nickel
SN

LENS

Adjustable TRI Lens gives a smooth uniform beam at 20° and 50° beam spreads

APPLICATION

Suitable for damp or dry location, interior use only

LED LAMP SPECIFICATIONS

Total Wattage: 9.3 Watts
 Color Temp: 3000K
 CRI: 92+
 Lumens: 360lm
 Lumen Per Watt: 38lm/w

DIMMING

- Dimmable to 1% Percent of Flicker <25%
- Triac and ELV dimming standard. Compatible with Lutron Diva, Skylark and Legrand ELV dimmers

COMPLIANCE LABEL

ETL (Conforms to UL1598 and CSA 22.2 #250.0)

WARRANTY

5 year warranty. See PureEdgeLighting.com

LINK TO 3D FILES

System	Fixture	Stem Height	Finish
M	SCO	1	SN
M Monorail	SCO Scope	1 1" (2.5cm)	SN Satin Nickel



FJ-SCO-1-SN
Satin Nickel

3000K | Rf: 90 | Rg: 103.5

Color Vector Graphic

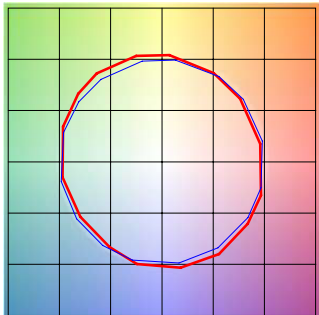

■ Test ■ Reference

HUE BIN	Rf	GRAPHIC SHIFTS %	
		CHROMA	HUE
1	92.5	-2.4%	-2.4%
2	93.6	-2.3%	2.1%
3	87.2	-0.1%	6.0%
4	86.9	3.8%	6.5%
5	90.1	6.0%	4.8%
6	88.1	7.1%	-0.0%
7	85.9	4.9%	-6.5%
8	90.7	1.6%	-5.3%
9	92.7	-1.9%	-3.9%
10	91.2	-3.9%	0.3%
11	88.6	-2.4%	6.4%
12	88.1	3.0%	4.9%
13	92.2	4.8%	0.7%
14	90.9	5.8%	-2.6%
15	89.4	3.2%	-5.3%
16	89.7	1.2%	-7.3%

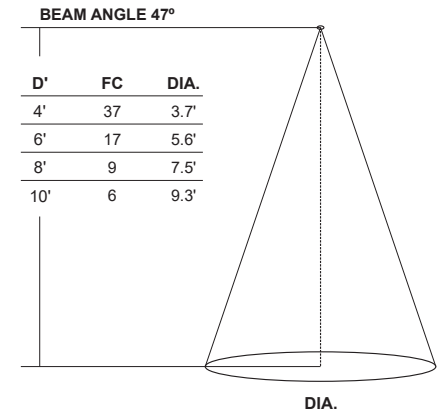
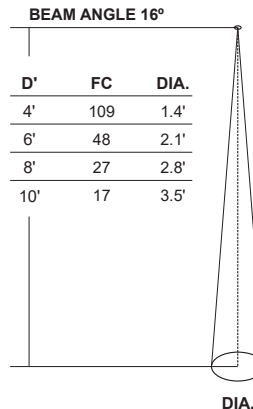

PROJECT	FIXTURE TYPE	DATE
---------	--------------	------



MONORAIL HEADS, PENDANTS AND SUSPENSIONS

12VAC

REBEL

LED, MONORAIL FIXTURE HEAD

DESCRIPTION

The contemporary cylinder-shaped Rebel is a versatile spotlight with a handle that can be removed after hot aiming. It rotates 360° and tilts 90°, performing as either an accent light or a stylish down light. The fixture allows easy re-lamping and holds up to three accessories.

FINISH & MATERIAL



Antique Bronze
BZ

Satin Nickel
SN

White
WH

- Tilt: 90°
- Rotation: 360°

SYSTEM MOUNTING OPTIONS

For use with any 12VAC Fast Jack Port including Monorail 1 Circuit Rail, MonoPoint canopies 2" or 4" round (**RD**), and multi-port canopies

APPLICATION

Suitable for damp or dry location, interior use only

LAMP SPECIFICATIONS

- Maximum 9 watt LED MR16 lamp GU 5.3 base - 12 volt (sold separately) up to 490 Lumens
- 2700K, 3000K, may be order in warm dim to 1800K

ACCESSORIES

May take up to 3, 2" round accessories, including glass lens or film lens. Louvers or snoot (see pg 4).

DIMMING

- Dimmable to 1% Percent of Flicker <25%
- Triac and ELV dimming standard. Compatible with Lutron Diva, Skylark and Legrand ELV dimmers

COMPLIANCE LABEL

ETL (Conforms to UL1598 and CSA 22.2 #250.0)

WARRANTY

5 year warranty. See PureEdgeLighting.com



FJ-REB-1-BZ
Antique Bronze



FJ-REB-1-SN
Satin Nickel



FJ-REB-1-WH
White

System	Fixture	Stem Height	Finish
M	REB	1	SN
M Monorail	REB Rebel	1 1.2" (2.5cm)	BZ Antique Bronze SN Satin Nickel WH White

PROJECT	FIXTURE TYPE	DATE
---------	--------------	------

2700K MR16 12V LED LAMPS					
Brand	SORAA			SOL-Light	
Ordering Code	SMT6-07-100-927-03	SMT6-09-25D-927-03	SMT6-09-36D-927-03	MR16-12V-8W-24D-300KWD-SL	MR16-12V-8W-36D-300KWD-SL
Wattage	8	9	9	8	8
CRI	95	95	95	97	97
Beam Angle (Degrees)	10	25	36	24	36
Total Lumens	390	465	465	468	450
Lumens Per Watt	52	52	52	50	55
Halogen Equivalent	50	60	60	50	50

3000K MR16 12V LED LAMPS					
Brand	SORAA			SOL-Light	
Ordering Code	SMT6-07-100-930-03	SMT6-09-25D-930-03	SMT6-09-36D-930-03	MR16-12V-8W-24D-300KWD-SL	MR16-12V-8W-36D-300KWD-SL
Wattage	8	9	9	8	8
CRI	95	95	95	97	97
Beam Angle (Degrees)	10	25	36	24	36
Total Lumens	410	490	490	468	450
Lumens Per Watt	55	54	54	53	58
Halogen Equivalent	50	60	60	50	50

SORAA VIVID MR16 36° FL

3000K | Rf: 90.4 | Rg: 99.5

Color Vector Graphic

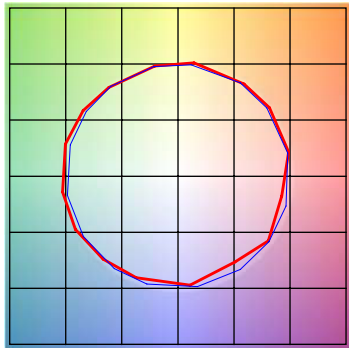

■ Test ■ Reference

GRAPHIC SHIFTS %				
HUE BIN	Rf	CHROMA	HUE	
1	94.4	1.0%	0.8%	
2	94.6	2.1%	-1.1%	
3	91.9	1.1%	-3.3%	
4	91.9	2.1%	-2.1%	
5	93.9	0.4%	-0.9%	
6	95.2	0%	1.9%	
7	93.4	2.7%	-0.7%	
8	92.7	4.2%	0.1%	
9	90.5	3.6%	-3.9%	
10	84.3	2.3%	-9.2%	
11	81.3	2.3%	-12.7%	
12	81.3	-3.6%	-10.3%	
13	90.5	-2.5%	-6.2%	
14	88.5	-8.2%	-0.4%	
15	96.2	-1.0%	0.3%	
16	86.6	-5.4%	8.2%	

SOL-LIGHT WARM DIM MR16 36° FL

3000K | Rf: 94.2 | Rg: 101.2

Color Vector Graphic

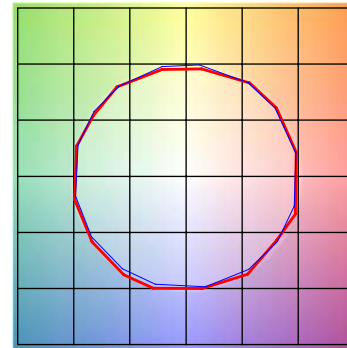

■ Test ■ Reference

GRAPHIC SHIFTS %				
HUE BIN	Rf	CHROMA	HUE	
1	96.0	0.3%	0.7%	
2	96.8	0.9%	-0.8%	
3	95.6	0.5%	-0.8%	
4	93.1	-3.2%	-2.7%	
5	95.7	-2.4%	0.4%	
6	96.8	0.4%	1.6%	
7	92.4	-1.4%	3.5%	
8	96.8	1.2%	1.2%	
9	94.0	1.4%	3.1%	
10	92.6	2.1%	3.9%	
11	92.2	3.7%	3.9%	
12	92.4	3.9%	-0.9%	
13	94.7	0.9%	-3.3%	
14	93.4	3.0%	-3.2%	
15	93.6	-1.1%	0.9%	
16	90.2	2.4%	-6.7%	

SORAA VIVID MR16 25° NFL

3000K | Rf: 94.0 | Rg: 101.0

Color Vector Graphic

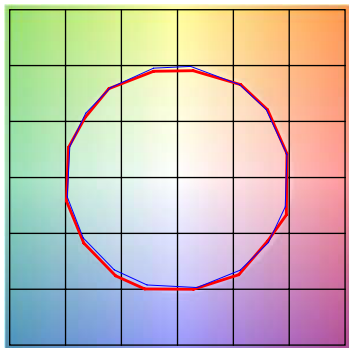

■ Test ■ Reference

GRAPHIC SHIFTS %				
HUE BIN	Rf	CHROMA	HUE	
1	95.9	0.3%	0.8%	
2	96.8	0.8%	-0.9%	
3	95.5	0.4%	-0.9%	
4	92.7	-3.4%	-2.9%	
5	95.6	-2.7%	0.4%	
6	96.8	0.1%	1.6%	
7	92.2	-1.6%	3.7%	
8	96.6	1.1%	1.5%	
9	93.7	1.4%	3.3%	
10	92.4	2.2%	4.1%	
11	92.2	3.8%	3.8%	
12	92.4	3.9%	-1.1%	
13	94.4	0.8%	-3.6%	
14	93.3	2.8%	-3.4%	
15	93.4	-1.4%	0.9%	
16	90.3	2.2%	-6.7%	

SOL-LIGHT WARM DIM MR16 24° NFL

3000K | Rf: 94.2 | Rg: 101.2

Color Vector Graphic

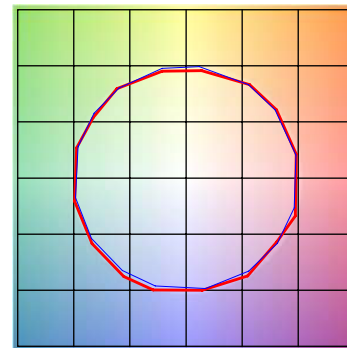

■ Test ■ Reference

GRAPHIC SHIFTS %				
HUE BIN	Rf	CHROMA	HUE	
1	95.9	0.3%	0.8%	
2	96.8	0.8%	-0.9%	
3	95.5	0.4%	-0.9%	
4	92.7	-3.4%	-2.9%	
5	95.6	-2.7%	0.4%	
6	96.8	0.1%	1.6%	
7	92.2	-1.6%	3.7%	
8	96.6	1.1%	1.5%	
9	93.7	1.4%	3.3%	
10	92.4	2.2%	4.1%	
11	92.2	3.8%	3.8%	
12	92.4	3.9%	-1.1%	
13	94.4	0.8%	-3.6%	
14	93.3	2.8%	-3.4%	
15	93.4	-1.4%	0.9%	
16	90.3	2.2%	-6.7%	

PROJECT	FIXTURE TYPE	DATE
---------	--------------	------

MR16 HEXCELL LOUVER

MR16 Hexcell Louver Accessory eliminates glare. 2" diameter x .125" thick.

Accessory

L016-H

L016-H MR16 Hexcell Louver

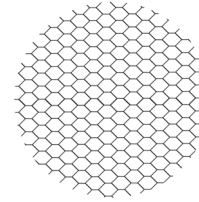

FILM LENS SOFT FOCUS

SF Soft Focus diffuses a beam pattern to provide even illumination. LS Linear spread lens directs 10°, 15°, 25° beams into an elongated shape. This is typically used in long rectangle paintings and art work, 35°, 40°, 60° lamps produce an elongated oval shape used in art work and wall washing.

Film Size Film Type

LF2 – **LS**

LF2 2" Film **LS** Linear Spread



2" ROUND GLASS OPTICAL LENS

The soft focus lens reduces lamp glare, spread lenses elongate and diffuser lenses diffuse the light beam. UV filter lens allows quality light to pass through while blocking the ultra violet radiation.

Lens Optical Type

L16 – **SF**

L16 MR16 Lens **SF** Soft Focus
WD Wide Diffuser
WDF Wide Diffuser Frost
LS Linear Spread
UV UV Glass*
**Limited quantities, call for availability*

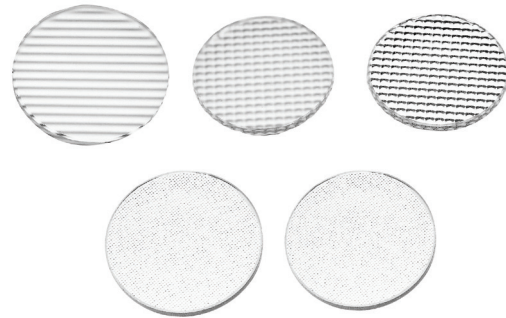

2" ROUND DICHROIC GLASS LENS

Dichroic lenses operate on a passive-reflective basis, reflecting unused wavelengths while allowing desired portions of the spectrum to pass through. Dichroics are high in transmission, producing brighter, cleaner, saturated colors.

Lens Dichroic Color

L16 – **GR**

L16 MR16 Lens **AM** Amber*
YL Yellow*
GR Green
CW Cool White (3100K-4250K)*
PH Peach*
DP Dark Pink*
**Limited quantities, call for availability*

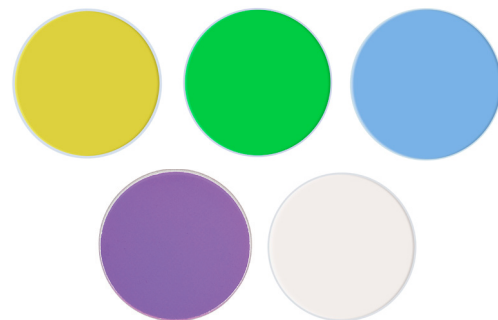

PROJECT	FIXTURE TYPE	DATE
---------	--------------	------

SALUTI

LED, MONORAIL FIXTURE HEAD

DESCRIPTION

The Saluti Pendant from PureEdge Lighting features a clean, contemporary profile made of glass. Choose from 2 Shade Colors. Dimmable with magnetic or electronic low voltage systems (sold separately). The Saluti Pendant can be used with any PureEdge 12V Fast Jack Connections. When used with the Multi-Port Linear or Round Canopy options from PureEdge Lighting, designers can create small to large scale designs.

SYSTEM COMPATIBILITY:

Monorail (**M**)

FINISH



Crystal Glass
CR



Gray Glass
GY

LAMP SPECIFICATION

LED: INCLUDED

- Total Watts: 2.2W (Equivalent to 10W Halogen)
- Total Lumens: 167
- Lumens Per Watt: 76
- Color Temperature: 2700K
- Color Rendering index: 85+ CRI

WEIGHT

4 lbs. (1.8kg)

LINK TO 3D FILES

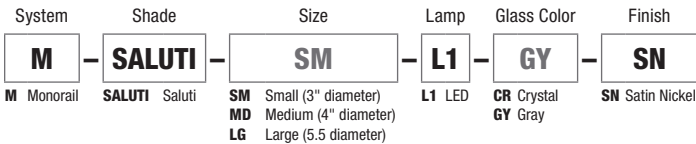

FJ-SALUTI-SM-GY-SN
Small (3" Diameter) Gray



FJ-SALUTI-MD-CR-SN
Medium (4" Diameter) Crystal



FJ-SALUTI-LG-GY-SN
Large (5.5" Diameter) Gray

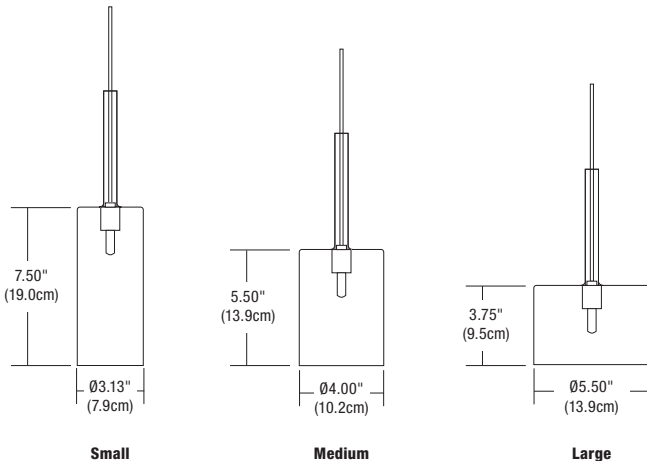

PROJECT	FIXTURE TYPE	DATE
---------	--------------	------



MONORAIL HEADS, PENDANTS AND SUSPENSIONS

12VAC



REV 10.13.22

BUBBLE BALL

LED, MONORAIL FIXTURE HEAD

DESCRIPTION

The Bubble Ball LED from PureEdge Lighting features cool-to-the-touch hand-blown glass which includes one 1.5 watt 2700K LED lamp for general light distribution. The Bubble Ball LED Pendant is offered in glass and finished in Satin Nickel hardware. Dimmable with magnetic or electronic low voltage systems. The Bubble Ball LED Pendant can be used with any PureEdge LED Fast Jack Connections. When used with the Multi-Port Linear or Round Canopy options from PureEdge Lighting, designers can create small to large scale designs. Field-cuttable (10', 20' or 30') coaxial cable and FJ-MCH (male connector heavy-duty) provided.

FINISH



Satin Nickel
SN

MATERIAL

Glass

SYSTEM MOUNTING OPTIONS

Fast Jack, Monorail, MonoPoint, MultiPoint, Linear Suspension, Vanishing Point 12V

LAMP

1.5 Watt, 2700K LED, 80 CRI (equivalent to 10-15 watt halogen)

WEIGHT

5 lb (2.28 kg)

DIMMING

- Dimmable to 1% Percent of Flicker <25%
- Triac and ELV dimming standard. Compatible with Lutron Diva, Skylark and Legrand ELV dimmers

COMPLIANCE

ETL (Conforms to UL1598 and CSA 22.2 #250.0)

WARRANTY

5 year prorated warranty. See PureEdgeLighting.com

LINK TO 3D FILES

System	Shade	Height	Voltage	Finish
M	BBCL27	10FT	12	SN
M Monorail	BBCL27 Bubble Ball, Clear Glass LED 2700K	10FT 10ft 20FT 20ft 30FT 30ft	12 12 Volts	SN Satin Nickel



FJ-BBCL27-10FT-12-SN
Clear

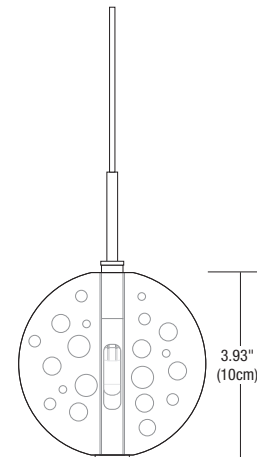

FJ-BBCL27

PROJECT	FIXTURE TYPE	DATE
---------	--------------	------

CIRRUS FLOAT MONORAIL

DESCRIPTION

Cirrus Float features a Direct (D1), Rectangular (R1) or a Tubular (T1) lens, offering an array of choices for style, functionality and beam distribution. At 7 watts per foot, the 12VAC fixtures contain very warm white or warm white 92+ CRI LEDs. Available in lengths from 36"-96". Differed in multiple lengths. Cirrus Float can be seamlessly integrated into PureEdge Monorail systems. Includes corresponding mounting hardware. Float fixtures feature adjustable aircraft cables that slide across the length of fixture for flexibility when mounting to the rail. Hardware and supporting cables are Satin Nickel for all finishes options. Power cables are Satin Nickel for all finish options. Fixture includes a 5 year warranty.

SYSTEM COMPATIBILITY

Monorail

FINISHES

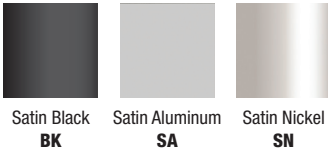

Custom finishes available

MONORAIL CONNECTOR FINISH

All finishes include Satin Nickel connectors

LAMP

Version	Watts per Foot	Lumens		92CRI 27K, 30K	50,000 Hour Lamp Life
		per Watt	per Foot		
D1	7	34	241	•	•
R1	7	36	262	•	•
T1	7	36	268	•	•

Lumen values are based on the 3000K LED test.

Warm White 100° 7 Watt	
Distance	Foot Candles
2ft	126
3ft	62
4ft	39
6ft	20
8ft	12

APPLICATIONS

Indoor - Architectural lighting, general lighting and retail. Mount fixture 70" above finished floor.

[LINK TO 3D FILES](#)

System	Product	Lens	Nominal Size (Length Inch)	Color Temperature	Finish
M	CF	D1	72IN	27K	SA
M Monorail	CF Cirrus Float 12 Volt	D1 Direct 0.9" Lens R1 Rectangular 0.9" Lens T1 Tubular 1.125" Lens	36 36.55" 57 57.55" 39 39.55" 60 60.55" 42 42.55" 63 63.55" 48 48.55" 66 66.55" 51 51.55" 69 69.55" 54 54.55" 72 72.55"	27K 2700K Very Warm White 30K 3000K Warm White	BK Black SA Satin Aluminum SN Satin Nickel

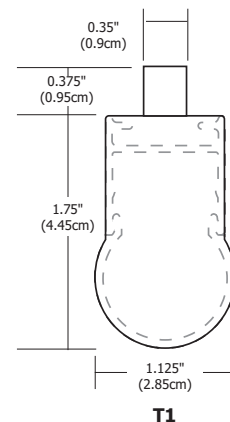
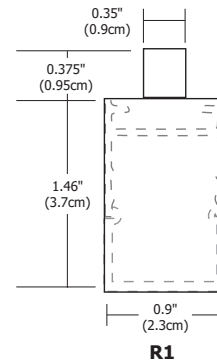
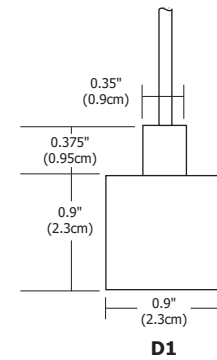
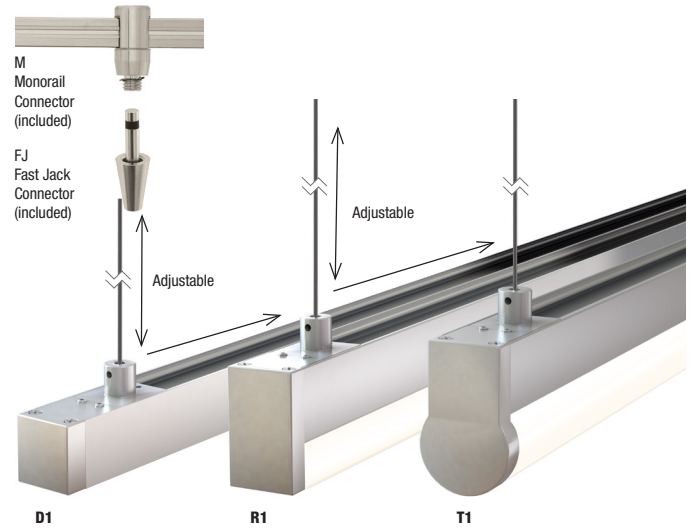

PROJECT	FIXTURE TYPE	DATE
---------	--------------	------

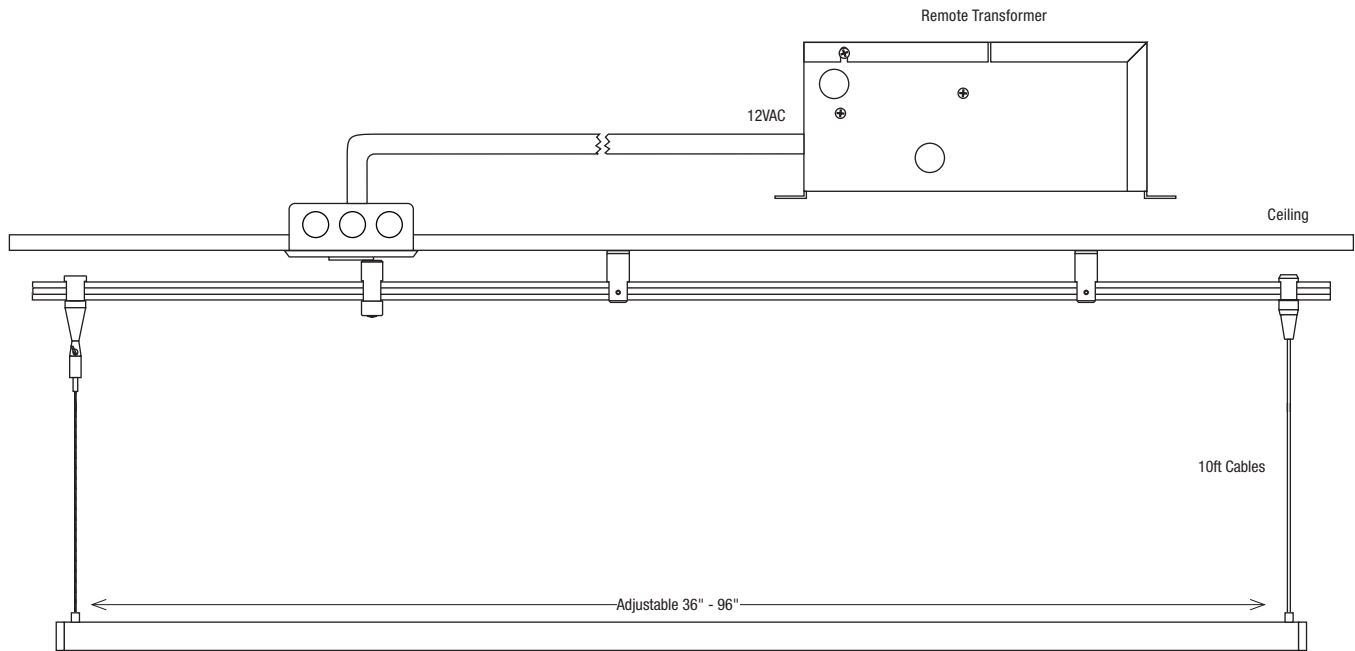
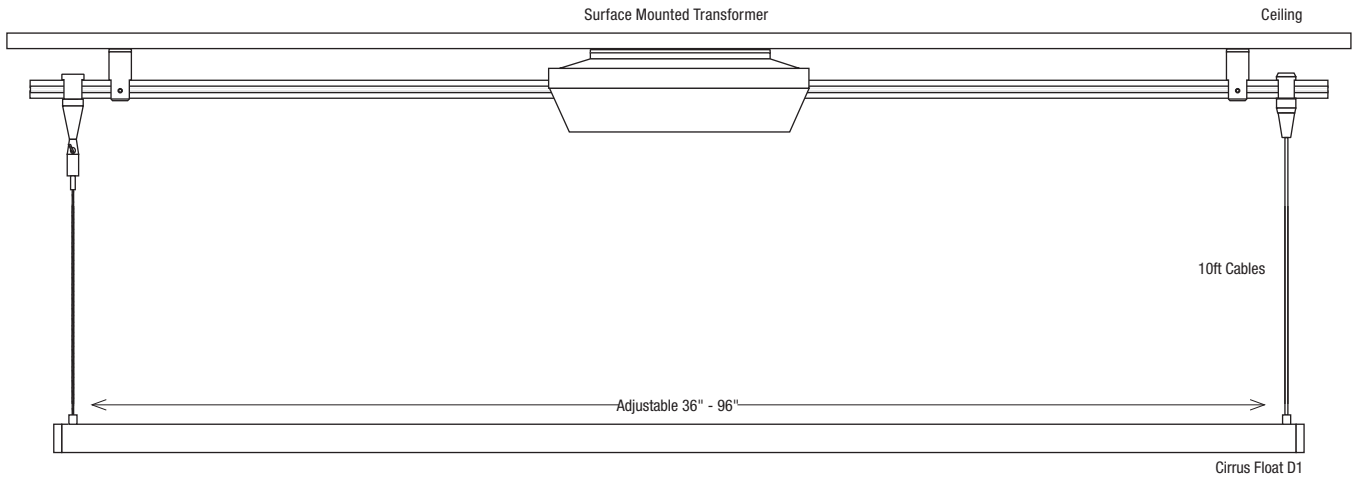

TM-30-15 DATA: The data below is for SS2C, SS5C, SS7C, and SS10C bare LED Soft Strips. Consistent color temperatures throughout a single strip and among multiple strips is possible through a 3 phase binning process in which each order is inspected with a color meter to ensure uniformity.

2700K | Rf: 87.7 | Rg: 96.1

Color Vector Graphic

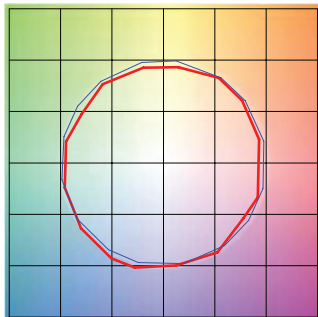

■ Test ■ Reference

HUE BIN	Rf	GRAPHIC SHIFTS %	
		CHROMA	HUE
1	88.0	-4.3%	2.6%
2	91.6	-2.4%	2.0%
3	93.7	-1.4%	1.9%
4	88.9	-5.6%	-3.1%
5	92.3	-5.5%	-0.5%
6	92.9	-3.5%	0.1%
7	84.5	-7.5%	4.6%
8	90.8	-3.0%	4.4%
9	84.5	-1.3%	8.3%
10	83.9	2.0%	9.8%
11	87.2	5.3%	7.1%
12	89.2	5.4%	-2.6%
13	88.7	0.3%	-7.8%
14	86.8	1.7%	-9.3%
15	87.6	-5.4%	-1.3%
16	83.6	-3.3%	-9.5%

3000K | Rf: 88.1 | Rg: 99.7

Color Vector Graphic

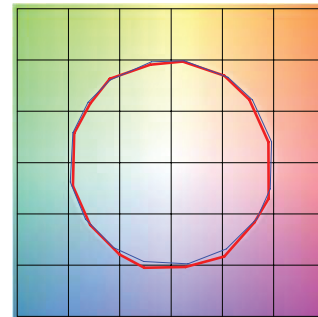

■ Test ■ Reference

HUE BIN	Rf	GRAPHIC SHIFTS %	
		CHROMA	HUE
1	92.5	-3.1%	0.3%
2	93.3	-2.3%	1.9%
3	90.9	-0.8%	3.9%
4	94.3	-1.1%	1.4%
5	92.5	-2.6%	1.5%
6	96.4	1.2%	-0.3%
7	92.6	-2.5%	-0.0%
8	96.9	-1.4%	0.2%
9	92.3	-1.8%	4.3%
10	86.6	-0.7%	7.0%
11	86.5	2.4%	8.2%
12	89.8	5.9%	1.7%
13	93.9	2.6%	-2.7%
14	89.4	5.1%	-5.8%
15	90.1	-0.1%	-4.7%
16	86.5	0.3%	-9.7%

PROJECT	FIXTURE TYPE	DATE
---------	--------------	------



MONORAIL HEADS, PENDANTS AND SUSPENSIONS

12VAC - LIMITED QUANTITIES AVAILABLE, CALL FOR PRICING



REV 10.13.22

PIPE

LED, MONORAIL FIXTURE HEAD

DESCRIPTION

The Pipe LED Multi-Port Family of Fixtures by PureEdge Lighting brings to life an array of configurations, giving the designer the tools to transform any space.

FINISH



Satin Nickel
SN

LAMP SPECIFICATION (PER PORT)

LED Module 8 Watt 3000K 80+CRI 12v; 70% lumen maintenance based on 50,000 hours of operation. Dimmable. 8' overall length, custom lengths available.

WEIGHT

Fixture weight 3lbs not including canopies

LINK TO 3D FILES

System	Fixture	Finish
M	LPIP	SN
M Monorail	LPIP LED Pipe	SN Satin Nickel

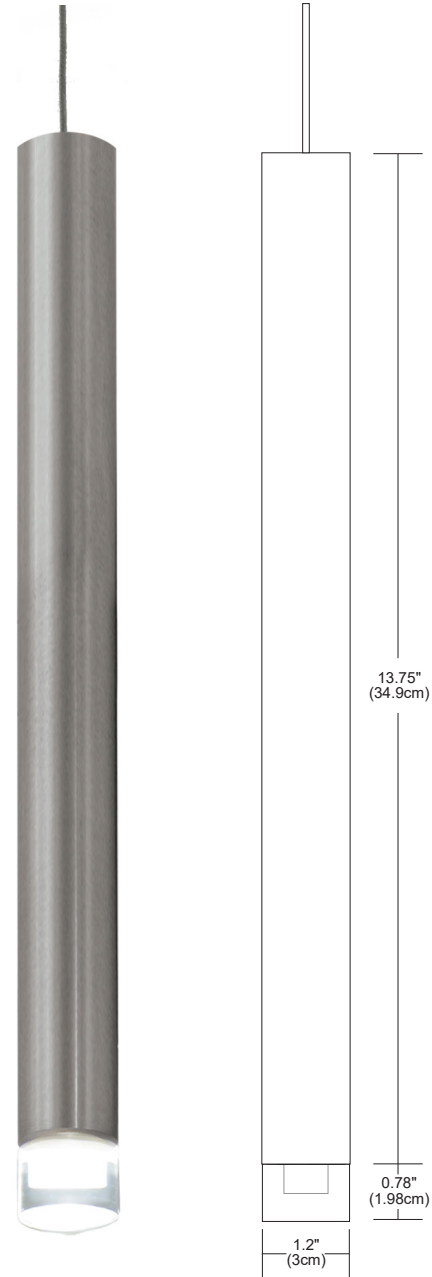

PROJECT		FIXTURE TYPE		DATE	
---------	--	--------------	--	------	--



MONORAIL HEADS, PENDANTS AND SUSPENSIONS

12VAC - LIMITED QUANTITIES AVAILABLE, CALL FOR PRICING

K2

LED

DESCRIPTION

The sleek candle-shaped K2 pendant provides 8 watts of 3000K LED light. It includes 8' of field-cutable coaxial cable and Fast Jack connector.

FINISH & MATERIAL



Satin Nickel
SN

- Machine from Bullet Aluminum
- Tilt: 90°
- Rotation: 360°

MOUNTING OPTIONS

For use with any Fast Jack Port including Monorail 1 & 2 Circuit Rail, MonoPoint canopies 2" or 4" round (**RD**)

LENS

Field changeable TRI Lens give a smooth uniform beam at 15°, 25°, 35° or 45° beam spreads

APPLICATION

Suitable for damp or dry location, interior use only

LED LAMP

650 lumens at 3000K, 95.5CRI, R9-80, Rf-93, Rg-99, Input voltage 12VAC, 9 Watts, Power Factor 0.90

DIMMING

- Dimmable to 1% Percent of Flicker <25%
- Triac and ELV dimming standard. Compatible with Lutron Diva, Skylark and Legrand ELV dimmers

COMPLIANCE LABEL

ETL (Conforms to UL1598 and CSA 22.2 #250.0)

WARRANTY

5 year warranty. See PureEdgeLighting.com

System	Shade	Voltage	Finish
M	K2	12	SN
M Monorail	K2 K2	12 12 Volt	SN Satin Nickel

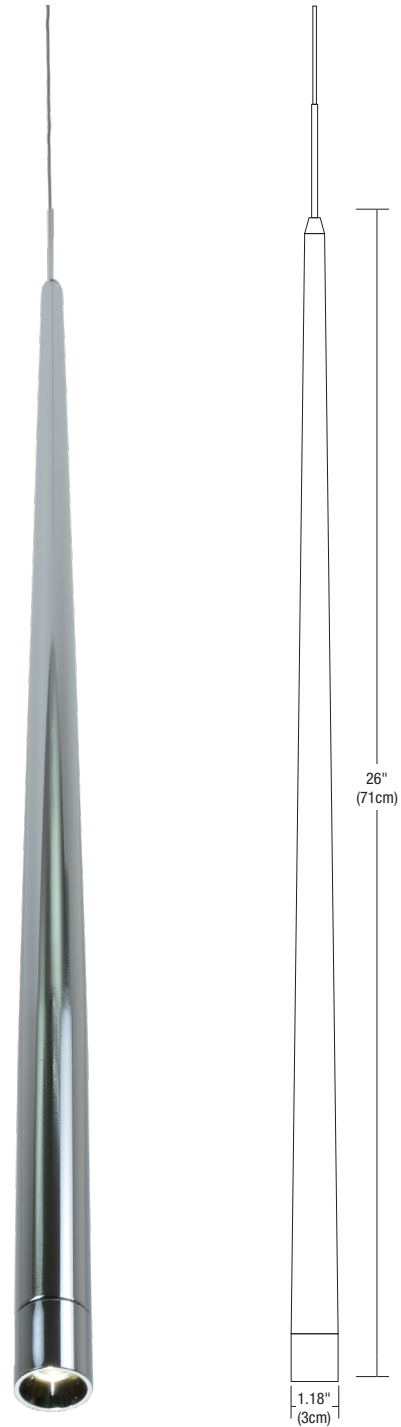

PROJECT	FIXTURE TYPE	DATE
---------	--------------	------



MONORAIL HEADS, PENDANTS AND SUSPENSIONS

12VAC

OUTLAW

LED, PENDANT FIXTURE HEAD

DESCRIPTION

Outlaw Lamp Pendant, is a blown white glass shaped like an incandescent "A" lamp with 20 watt bi-pin halogen lamp inside. Available with 30' long field-cutttable coaxial cable that may be cut in at the job site.

SYSTEM COMPATIBILITY

Monorail (M), any Fast Jack (FJ) power canopy or track transformer (sold separately)

FINISH & MATERIAL



Satin Nickel
SN

LAMP SPECIFICATION

Maximum 20 watt G4 bi-pin halogen (included)

WEIGHT

- 1 lb (0.45 kg)Legrand ELV dimmers

COMPLIANCE LABEL

ETL (Conforms to UL1598 and CSA 22.2 #250.0)

WARRANTY

5 year warranty. See PureEdgeLighting.com

System	Shade	Cable/Cord	Voltage	Finish
M	OL	30FT	12	SN
M Monorail	OL Outlaw	30FT 30'	12 12 Volt	SN Satin Nickel

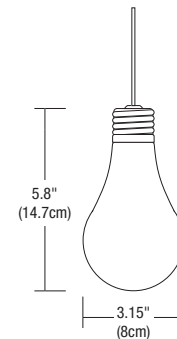

PROJECT	FIXTURE TYPE	DATE
---------	--------------	------



MONORAIL HEADS, PENDANTS AND SUSPENSIONS

12VAC



REV 10.13.22

CRYSTAL GALAXY

LED, PENDANT FIXTURE HEAD

DESCRIPTION

Crystal Galaxy is a miniature polished nickel chandelier with crystals intertwined throughout the fixture. Eight feet of field-cutable coaxial cable provided.

FINISH & MATERIAL



Satin Nickel
SN

- Machined from Bullet Aluminum

SYSTEM MOUNTING OPTIONS

For use with any 12VAC Fast Jack Port including Monorail 1 & 2 Circuit Rail, MonoPoint canopies 2" or 4" round (RD), and multi-port canopies

APPLICATION

Suitable for damp or dry locations, interior use only

LAMP

30 x 2W Xenon (lamps included)

WEIGHT

2 lb (.9 kg)

DIMMING

- Dimmable to 1% Percent of Flicker <25%
- Triac and ELV dimming standard. Compatible with Lutron Diva, Skylark and Legrand ELV dimmers

COMPLIANCE LABEL

ETL (Conforms to UL1598 and CSA 22.2 #250.0)

WARRANTY

5 year warranty. See PureEdgeLighting.com



M-CRYGA16-12-SN

System	Fixture	Voltage	Finish
M	CRYGA16	12	SN
M Monorail	CRYGA16 Crystal Galaxy	12 12 Volt	SN Satin Nickel

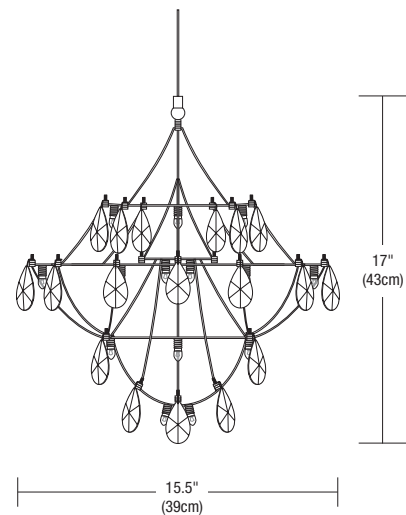

PROJECT	FIXTURE TYPE	DATE
---------	--------------	------

S6 ROUND SHADE

Round Metal Shade fits on Chopper or Vespa and holds two Lenses or a combination of a Louver and Lens using the attached Louver Lens Holder, up to 37 watt IR MR16.

Accessory	Finish
S6	BK

S6 Round Shade **BK** Black
Limited quantities, call for availability.

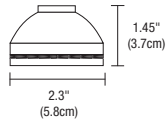

S7 ROUND MESH SHADE

Round Mesh Shade fits on Chopper or Vespa and holds two Lenses or a combination of a Louver and Lens using the attached Louver Lens Holder, up to 75 watt MR16.

Accessory	Finish
S7	BK

S7 Round Mesh Shade **BK** Black
Limited quantities, call for availability.

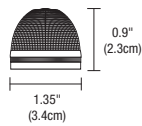

MR16 HEXCELL LOUVER

MR16 Hexcell Louver Accessory eliminates glare from the light beam. 2" diameter x .125" thick.

Accessory	Type
L016	H

L016 Lens Holder MR16 **H** Hexcell

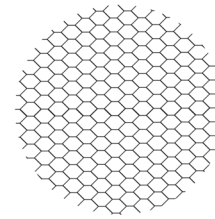



MONORAIL HEADS, PENDANTS AND SUSPENSIONS

12VAC



REV 10.13.22

FORM ROUND & SQUARE 2 HEAD

LED, MONOPOINT FIXTURE HEAD

DESCRIPTION

The lightweight, geometric Form functions with two MR16 12VAC LED lamps. Available in round or square versions, the contemporary adjustable accent light rotates 360° and tilts 50°. The easy-to-aim fixture holds one accessory lens or louver.

SYSTEM COMPATIBILITY

Monorail, Fast Jack, Monopoint, Multipoint

HEIGHT

3" (7.6cm)

FINISHES



Satin Nickel
SN

LAMP SPECIFICATION

- Maximum 9 watt LED MR16 lamp
- LED MR16 lamp GU 5.3 base - 12 volt (sold separately) up to 490 Lumens 2700K, 3000K, may be order in warm dim to 1800K

OPTICAL ACCESSORIES (SOLD SEPARATELY)

Hexcell Louver, Glass Lenses or Snoot

WEIGHT

.30 lb (.14 kg)



FJ-F0R-2SQ-3-SN

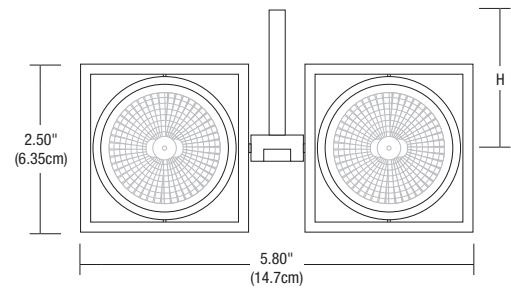

System	Fixture	Type	Height (H)	Finish
M	FOR	2SQ	3	SN
M Monorail	FOR Form	2SQ Square 2-Head	3 3" (7.6cm)* 6 6" (15.2cm) 36 36" (91.4cm)	SN Satin Nickel

Limited quantities available, call for pricing.

PROJECT		FIXTURE TYPE		DATE	
---------	--	--------------	--	------	--



MONORAIL HEADS, PENDANTS AND SUSPENSIONS

12VAC



REV 10.13.22

MR16 HEXCELL LOUVER

MR16 Hexcell Louver Accessory eliminates glare. 2" diameter x .125" thick.

Accessory

L016-H

L016-H MR16 Hexcell Louver

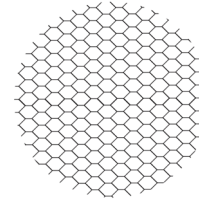

FILM LENS SOFT FOCUS

SF Soft Focus diffuses a beam pattern to provide even illumination. LS Linear spread lens directs 10°, 15°, 25° beams into an elongated shape. This is typically used in long rectangle paintings and art work, 35°, 40°, 60° lamps produce an elongated oval shape used in art work and wall washing.

Film Size Film Type

LF2 - **LS**

LF2 2" Film **LS** Linear Spread



2" ROUND GLASS OPTICAL LENS

The soft focus lens reduces lamp glare, spread lenses elongate and diffuser lenses diffuse the light beam. UV filter lens allows quality light to pass through while blocking the ultra violet radiation.

Lens Optical Type

L16 - **SF**

L16 MR16 Lens
SF Soft Focus
WD Wide Diffuser
WDF Wide Diffuser Frost
LS Linear Spread
UV UV Glass*
**Limited quantities, call for availability*

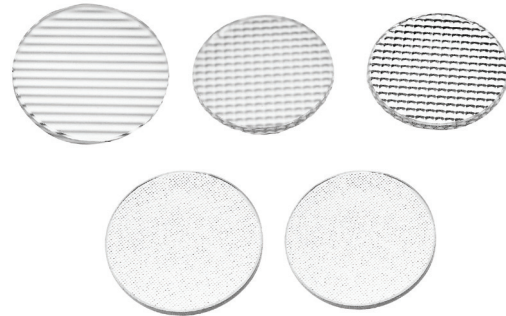

2" ROUND DICHROIC GLASS LENS

Dichroic lenses operate on a passive-reflective basis, reflecting unused wavelengths while allowing desired portions of the spectrum to pass through. Dichroics are high in transmission, producing brighter, cleaner, saturated colors.

Lens Dichroic Color

L16 - **GR**

L16 MR16 Lens
YL Yellow*
GR Green
CW Cool White (3100K-4250K)*
PH Peach*
DP Dark Pink*
**Limited quantities, call for availability*

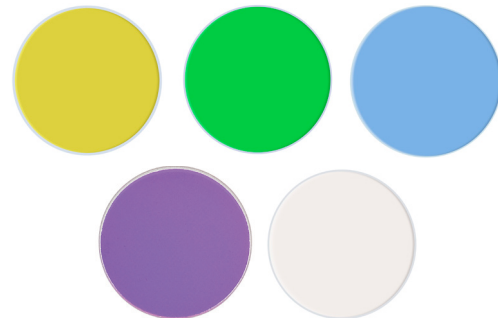

PROJECT	FIXTURE TYPE	DATE
---------	--------------	------

LOW RIDER

LED, MONOPOINT FIXTURE HEAD

DESCRIPTION

Petite yet versatile, the classic Low Rider spotlight rotates 360° and tilts 90°. Select from a variety of shades to personalize the timeless design (Sold Separately).

FINISH & MATERIAL



Antique Bronze **BZ** Satin Nickel **SN**

- Machined from Billet Aluminum
- Tilt: 90°
- Rotation: 360°

*Limited quantities available. Please call for more information.

SYSTEM MOUNTING OPTIONS

For use with any 12VAC Fast Jack Port including Monorail Circuit Rail, Mono-Point canopies 2" or 4" round (**RD**), and multi-port canopies

APPLICATION

Suitable for damp or dry location, interior use only

LAMP SPECIFICATIONS

- LED MR16 lamp GU 5.3 base - 12 volt (sold separately) up to 490 Lumens 2700K, 3000K, may be order in warm dim to 1800K
- Halogen lamp Max 50 watt monopoint canopy only

HEIGHT

1.2" (3cm), 3" (7.6cm)

DIMMING

- Dimmable to 1% Percent of Flicker <25%
- Triac and ELV dimming standard. Compatible with Lutron Diva, Skylark and Legrand ELV dimmers

COMPLIANCE LABEL

ETL (Conforms to UL1598 and CSA 22.2 #250.0)

WARRANTY

5 year warranty. See PureEdgeLighting.com



FJ-LOW-1-SN-S1-SN
Satin Nickel



FJ-LOW-1-SN-S1-SN
Satin Nickel with Satin Nickel S1 Shade

System	Fixture	Stem Height	Finish
M	LOW	3	SN

M Monorail **LOW** Low Rider **1** 1" (2.5 cm) **BZ** Antique Bronze
3 3" (7.6 cm) **SN** Satin Nickel
6 6" (15.2 cm)

*Limited quantities available, call for pricing.

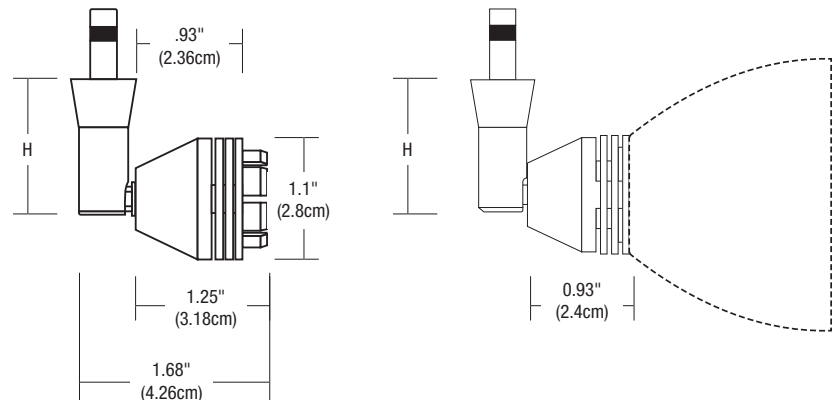

PROJECT	FIXTURE TYPE	DATE
---------	--------------	------



MONORAIL HEADS, PENDANTS AND SUSPENSIONS

12VAC



REV 10.13.22

S1 LITTLE SHADE

Small, Solid Metal Shade fits on Low Rider or Vespa and holds a Single Lens or Louver using a Snap Louver Lens Holder (included), up to 50 watt MR16.

Accessory	Finish
S1	SN
S1 Little Shade	SN Satin Nickel



S5 GLASS SHADE

Big, Solid Metal Shade fits on Low Rider and holds a Single Lens or Louver using a Snap Louver Lens Holder (included), up to 50 watt MR16.

Accessory	Finish
S5	SN
S5 Big Shade	SN Satin Nickel

Limited quantities available. Please call for more information.



PROJECT		FIXTURE TYPE		DATE	
---------	--	--------------	--	------	--

MR16 HEXCELL LOUVER

MR16 Hexcell Louver Accessory eliminates glare. 2" diameter x .125" thick.

Accessory

L016-H

L016-H MR16 Hexcell Louver

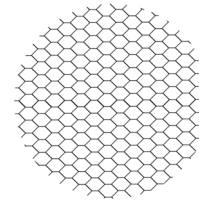

FILM LENS SOFT FOCUS

SF Soft Focus diffuses a beam pattern to provide even illumination. LS Linear spread lens directs 10°, 15°, 25° beams into an elongated shape. This is typically used in long rectangle paintings and art work, 35°, 40°, 60° lamps produce an elongated oval shape used in art work and wall washing.

Film Size Film Type

LF2 - **LS**

LF2 2" Film **LS** Linear Spread



2" ROUND GLASS OPTICAL LENS

The soft focus lens reduces lamp glare, spread lenses elongate and diffuser lenses diffuse the light beam. UV filter lens allows quality light to pass through while blocking the ultra violet radiation.

Lens Optical Type

L16 - **SF**

L16 MR16 Lens **SF** Soft Focus
WD Wide Diffuser
WDF Wide Diffuser Frost
LS Linear Spread
UV UV Glass*
**Limited quantities, call for availability*

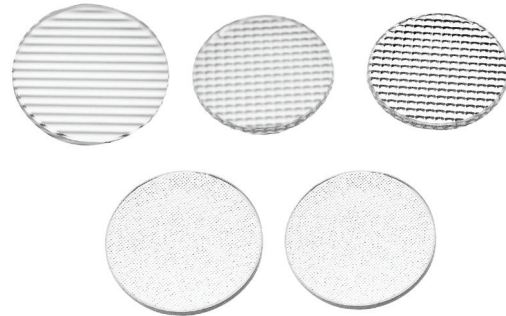

2" ROUND DICHROIC GLASS LENS

Dichroic lenses operate on a passive-reflective basis, reflecting unused wavelengths while allowing desired portions of the spectrum to pass through. Dichroics are high in transmission, producing brighter, cleaner, saturated colors.

Lens Dichroic Color

L16 - **GR**

L16 MR16 Lens **YL** Yellow*
GR Green
CW Cool White (3100K-4250K)*
PH Peach*
DP Dark Pink*
**Limited quantities, call for availability*

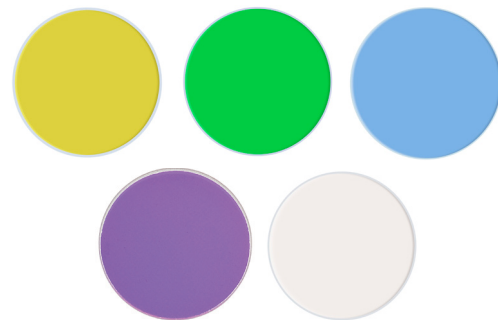

FAST JACK COAXIAL PENDANT CONNECTOR

Use the Fast Jack Monorail Coaxial Connectors to adapt any coaxial pendant fixtures (with 3/32" diameter coaxial cable) to Edge Lighting Monorail or Monorail 2 Circuit system and to Fast Jack canopies. The FJ-MCH is for fixtures over 5 lbs, Satin Nickel, 0.10 lb (.045 kg).

System Type Finish

FJ - **MC** - **SN**

FJ Fast Jack **MC** Male Connector **SN** Satin Nickel
MCH Male Connector Heavy Duty

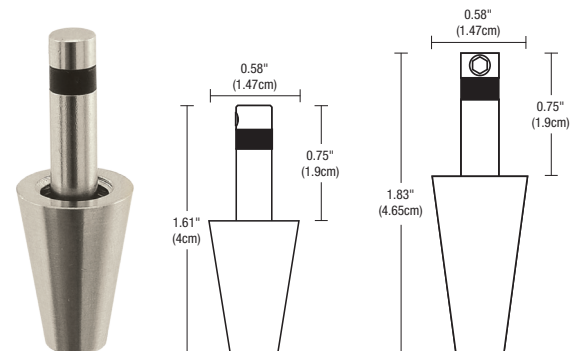
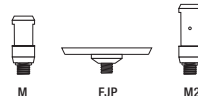

PROJECT	FIXTURE TYPE	DATE
---------	--------------	------