

TUBO LARGE TRACK DOWNLIGHT

24VDC INTEGRATED LED, STATIC WHITE & WARM DIM TECHNOLOGY

DESIGNED BY GREGORY KAY | ASSEMBLED IN AMERICA

REV 07.08.22



T24-TUBLD-SP-30K-WH

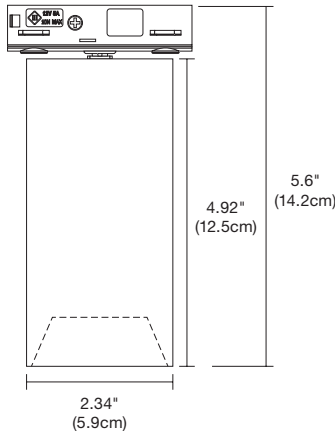

DESCRIPTION:

The Tubo Large Downlight is a 14-watt track luminaire that delivers up to 1268 lumens making the most out of ceiling space while exhibiting a simple yet appealing modern design. Being part of an entirely Low Voltage 24VDC system, it offers unsurpassed efficiency in comparison to traditional track lighting systems. The cylindrical flat-back design houses the heat-sink, LED module, and integrated driver within die-cast aluminum to help dissipate heat and improve life. Available in five Color Temperatures including Warm Dim (**30D**), that dims from 3000K-1800K exhibiting designer-grade color rendering as high as 98 CRI and R9-90. Offered in multiple beam spread options and accessories including field-changeable lenses. With every element designed to be slender and unobtrusive, the Tubo Large Downlight provides superb illumination and functionality within a small package.

MOUNTING OPTIONS:

Compatible with TruTrack Recessed Track (**TR24-1C, TR24-2C**) Pipeline Systems including Modular Suspension, Pipeline Track Suspension with Up Light and Pipeline Stem Mount Wall/Display (**P1SDM, PT, PSTU2CR, PSTU2CR**) and Surface Mount track (**TS24-1C**)

REMOTE POWER SUPPLIES (SOLD SEPARATELY)

24VDC, Class 2 wiring

- [Pure Smart™ WiZ Pro Power Supplies & Controls](#)
- [UNI Driver](#): Universal Dimming (**TRIAC, ELV, 0-10V**)

LAMPING

COLOR TEMPERATURE	BEAM ANGLE REFERENCE 45°				
	24K	27K	30K	30D	35K
TOTAL LUMENS	1238	1035	1069	683	1268
WATTS	14	14	14	14	14
LUMENS PER WATT (lm/w)	88	74	76	49	91
CRI	97	92	91	97	98
TM-30 DATA	R9: 60 Rf: 93 Rg: 98	R9: 97 Rf: 92 Rg: 100	R9: 64 Rf: 91 Rg: 98	R9: 90 Rf: 95 Rg: 102	R9: 92 Rf: 94 Rg: 101
LAMP LIFE	60,000 Hours, 70% Lumen Maintenance				

ACCESSORIES

Field-changeable lenses provide a smooth uniform beam at **NS** (10°), **SP** (20°), **NF** (35°), **FL** (45°), **VW** (75°) beam spread options

APPLICATIONS

Designed for indoor use only, dry and damp locations. Ideal applications in Commercial, Retail, Residential, Hospitality, Education, and Healthcare Institutions.

WARRANTY / LABELS

Pro-rated 5 year warranty. Assembled in America, ETL (Conforms to UL1598 and CSA 22.2 #250.0) RoHs, Title 24 JA8 with universal power supplies in 27K> CCT.

FINISHES

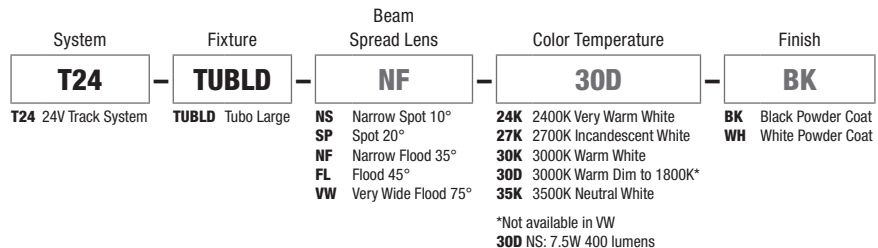
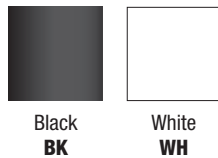





PROJECT	FIXTURE TYPE	DATE
---------	--------------	------

TUBO LARGE TRACK DOWNLIGHT

24VDC INTEGRATED LED, STATIC WHITE & WARM DIM TECHNOLOGY

REV 07.08.22

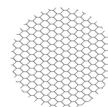
ADDITIONAL LENSES & ACCESSORIES

	TUBO LARGE LENS		SNOOT		LOUVER	FOCUS LENS	LINEAR SPREAD FILM
							
ORDERING CODE	STATIC WHITE LEN-TUBL-SP-SW LEN-TUBL-NF-SW LEN-TUBL-FL-SW LEN-TUBL-VW-SW	WARM DIM LEN-TUBL-SP-WD LEN-TUBL-NF-WD LEN-TUBL-FL-WD LEN-TUBL-VW-WD	STB16-BK STB16-WH (WHITE SHELL)	ST16-BK ST16-WH	L016-H	LF-TUBL-SF (SOFT FOCUS), MF (MEDIUM FOCUS), WF (WIDE FOCUS)	LF-TUBL-LS
LENS SIZE	2" (50mm) Diameter						
BEAM SPREADS	SP (20°), NF (35°) FL (45°), VW (75°)		Conical snoot creates a 7° Beam spread and is designed to reduce spill and control glare. Spun aluminum.	Snoot is designed to reduce spill and control glare. Spun aluminum.	Hexcell louver eliminates glare. 0.125" Thickness.	Soft focus lens is included with every track head. Diffuses the beam, providing uniform illumination.	Linear spread film: directs the light into an elongated beam. Typical applications using 10°, 15°, 25° include illuminating landscape oriented art. 35°, 40°, 60° create an elongated oval typically used for wall washing.

TUBO LARGE Photometric Data at 3000K CCT

D - Distance from fixture
FC - Initial foot candles at the center of beam
DIA - Diameter

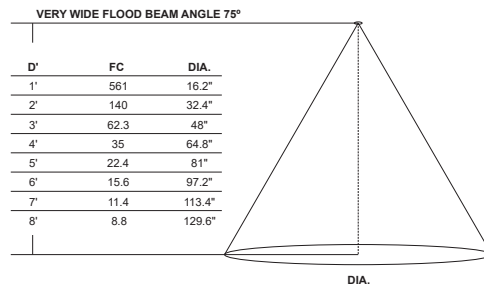
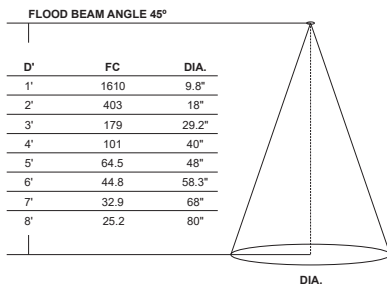
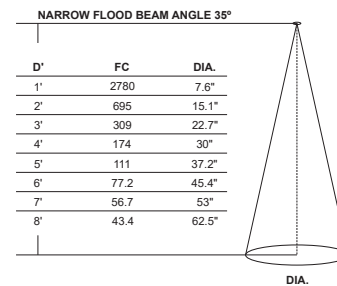
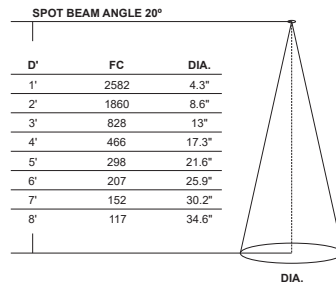
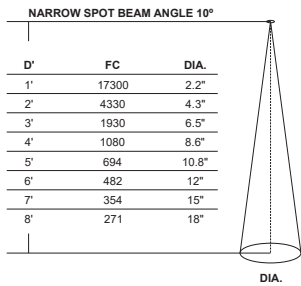

PROJECT		FIXTURE TYPE		DATE	
---------	--	--------------	--	------	--

DOWNLIGHT TM30 DATA

24VDC INTEGRATED LED, STATIC WHITE & WARM DIM TECHNOLOGY

TM-30 DATA: The data below is for Tubo Downlight. Consistent color temperatures among multiple track heads is possible through a 3 phase binning process in which each order is inspected with a color meter to ensure uniformity.

2400K | Rf: 91.0 | Rg: 99.6

Color Vector Graphic

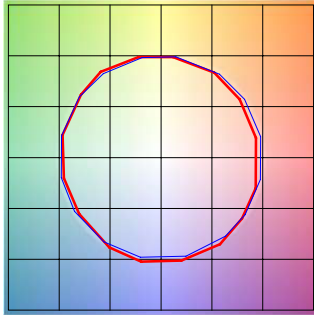

■ Test ■ Reference

		GRAPHIC SHIFTS %	
HUE BIN	Rf	CHROMA	HUE
1	90.1	-4.6%	-0.3%
2	90.6	-4.0%	2.7%
3	88.6	-1.6%	5.1%
4	93.1	-0.9%	2.7%
5	94.6	1.1%	3.3%
6	94.6	2.9%	1.0%
7	94.1	-0.2%	-2.7%
8	97.1	-0.9%	-1.2%
9	94.5	-2.4%	1.0%
10	90.3	-2.5%	4.5%
11	88.6	1.5%	7.1%
12	89.2	4.1%	1.5%
13	90.6	3.4%	-5.3%
14	84.5	3.5%	-8.9%
15	92.3	-0.5%	-4.7%
16	85.4	-2.9%	-9.4%

2700K | Rf: 93.3 | Rg: 98.8

Color Vector Graphic

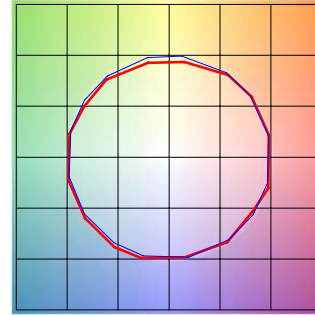

■ Test ■ Reference

		GRAPHIC SHIFTS %	
HUE BIN	Rf	CHROMA	HUE
1	95.9	0.3%	0.7%
2	95.5	0.6%	-2.0%
3	93.7	-0.8%	-2.8%
4	89.8	-5.2%	-4.0%
5	93.1	-5.2%	0.2%
6	93.9	-2.4%	2.9%
7	89.0	-3.1%	5.5%
8	93.6	0.5%	3.7%
9	92.9	1.2%	3.8%
10	92.7	2.0%	3.9%
11	93.7	3.2%	2.9%
12	93.7	2.7%	-1.8%
13	94.9	-0.7%	-3.4%
14	94.7	1.3%	-2.4%
15	92.9	-2.1%	2.0%
16	92.2	1.7%	-5.0%

3000K | Rf: 90.5 | Rg: 98.0

Color Vector Graphic

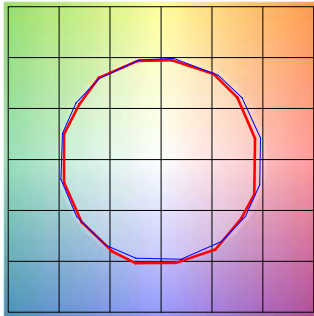

■ Test ■ Reference

		GRAPHIC SHIFTS %	
HUE BIN	Rf	CHROMA	HUE
1	88.7	-5.3%	0.5%
2	90.7	-3.6%	2.8%
3	89.4	-1.7%	4.6%
4	93.3	-2.1%	1.4%
5	94.6	-0.8%	2.2%
6	96.2	0.6%	-0.2%
7	92.5	-3.4%	-0.9%
8	96.4	-1.7%	0.5%
9	92.0	-2.4%	3.7%
10	87.3	-1.1%	7.1%
11	87.6	1.7%	8.2%
12	89.2	4.8%	0.4%
13	90.6	2.5%	-5.7%
14	86.7	3.3%	-9.0%
15	90.9	-2.4%	-3.9%
16	84.1	-3.5%	-10.3%

3000D | Rf: 90.5 | Rg: 98.0

Color Vector Graphic

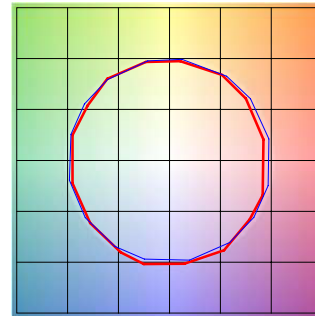

■ Test ■ Reference

		GRAPHIC SHIFTS %	
HUE BIN	Rf	CHROMA	HUE
1	88.7	-5.3%	0.5%
2	90.7	-3.6%	2.8%
3	89.4	-1.7%	4.6%
4	93.3	-2.1%	1.4%
5	94.6	-0.8%	2.2%
6	96.2	0.6%	-0.2%
7	92.5	-3.4%	-0.9%
8	96.4	-1.7%	0.5%
9	92.0	-2.4%	3.7%
10	87.3	-1.1%	7.1%
11	87.6	1.7%	8.2%
12	89.2	4.8%	0.4%
13	90.6	2.5%	-5.7%
14	86.7	3.3%	-9.0%
15	90.9	-2.4%	-3.9%
16	84.1	-3.5%	-10.3%

3500K | Rf: 93.9 | Rg: 100.9

Color Vector Graphic

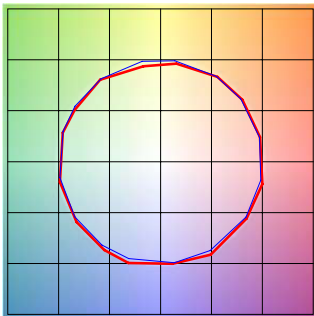

■ Test ■ Reference

		GRAPHIC SHIFTS %	
HUE BIN	Rf	CHROMA	HUE
1	95.7	0.6%	0.3%
2	96.7	0.8%	-1.2%
3	96.0	0.2%	-1.0%
4	94.3	-2.5%	-1.9%
5	93.2	-4.8%	-0.2%
6	97.1	-0.3%	1.4%
7	93.8	-1.7%	3.2%
8	97.3	0.2%	1.3%
9	93.3	0.8%	4.2%
10	91.4	1.4%	5.2%
11	90.6	2.8%	4.5%
12	92.6	4.4%	0.5%
13	96.3	0.7%	-1.9%
14	93.9	3.6%	-1.8%
15	92.4	1.2%	-0.9%
16	91.5	2.3%	-3.3%

PROJECT	FIXTURE TYPE	DATE
---------	--------------	------