

# LIGHT CHANNEL 45° ANGLED COMPLETE FIXTURE

24VDC SURFACE MOUNT LIGHT CHANNEL, STATIC WHITE & COLOR, TUNABLE WHITE, WARM DIM & RGB

DESIGNED BY GREGORY KAY | ASSEMBLED IN AMERICA

REV 02.23.22



## DESCRIPTION

Light Channel 45° Angle Surface Mount Lighting System is a made-to-order complete fixture, purchased in nominal increments of 2", 3", 5", 8" and 10". Light Channels may be ordered from 12" up to 120" (10'). The 45° angle channel gives more flexibility to the designer when trying to place light where it is most difficult. The Tunable White option offers full range dimming at full brightness from 2000K to 6500K color temperatures. Warm Dim technology is available in (27D) or (30D) Dims @ 3000K or 2700K down to 2000K. Tunable White and Warm Dim Soft Strip technology is only available in 5 watts only. For longer continuous runs, see DIY spec sheet.

## FEATURES AND BENEFITS

- 24VDC LED Strip provides up to 94+ CRI values offers excellent Designer Luxury Grade color rendering and fits inside a slim profile aluminum extrusion
- Low voltage up to 100 watt. Class 2 wiring, eliminates the need for conduit
- Power Consumption Options: 2.5W | 4.4W | 4.8W | 7.3W per foot
- Average life: 50,000 hours
- 5-year warranty

## LENS OPTIONS

- Clear Lens (C) provides maximum illumination use of a 40° transparent clear lens, LEDs diodes will show
- Diffused White Lens (D) projects clean lines of light 100° eliminating pixelation
- Diffused Lens with Gel Color Filter (G) (Provided by Customer) Clear and Diffuser Lens are Gel Color Filter Suitable allowing for color personalization. Zircon LED Gel filters recommended. Purchase Gel Lens from [www.leeefilters.com](http://www.leeefilters.com). See manufacturer spec sheet for more information.

## INCLUDED COMPONENTS

- 96" of Solderless Snap & Light Power Connector (Included 1 per fixture). Order extra as needed based on your installation requirements.
- Mounting Clips (Included with every 2' of Channel)

## ADDITIONAL ACCESSORIES (SOLD SEPARATELY)

- Mounting Clips (Included with every 2' of Channel)
- Solderless Snap & Light Power/Jumper Connector
- Soft Strip Solderless Snap & Light Straight Joiner
- Solderless Light Channel Connectors L, T & X

## POWER SUPPLIES\*, DIMMERS & CONTROLS (REMOTE SOLD SEPARATELY)

24VDC, Class 2 wiring

### Static White & Warm Dim

- [UNI Driver: Universal Dimming \(TRIAC, ELV, 0-10V\)](#)
- [Electronic Low Voltage \(ELV\)†](#)

### Lutron

- [Lutron Hi-Lume/Ecosystem](#)

### Tunable White

- [0-10V](#): Requires two dimmers, one for intensity and one for color temperature

- [DMX Dynamic Color Changing](#): Must be used with PureEdge [Controllers](#)

### RGB/RGB+W

- [DMX Dynamic Color Changing](#)
- [Controllers](#)

\*In-wall mounting and drop ceiling kits available for select power supplies

†ELV power supplies are not compatible with night, use only Universal power supplies

## APPLICATIONS

Indoor Only - Hospitality, Restaurants, Retail, Display Cabinet Lighting, Under Cabinet Lighting, Above Cabinet Up-Lighting, Toe Kick, Cove, Night Clubs, General Lighting, Warm Dim, Dim-to-Warm, Tunable White, Human Centric Lighting

Product	Wattage	Nominal Size	Color Temperature	Finish	
<b>LC45</b>	<b>2W</b>	<b>60</b>	<b>D</b>	<b>22K</b>	
<b>LC45</b> Light Channel Surface Mount 45°	<b>2W</b> 2.5 watts <b>5W</b> 4.4 Watts <b>7W</b> 7.3 Watts	<b>12-120</b> Order in 12" increments up to 120". May be ordered in 3", 5", 8" or 10" increments.	<b>D</b> Diffused Lens <b>C</b> Clear Lens <b>G</b> Diffused Lens with Gel Color (Provided by Customer)	<b>20K</b> 2000K Sunset <b>22K</b> 2200K Amber White <b>24K</b> 2400K Very Warm White <b>27K</b> 2700K Incandescent White <b>27D</b> 2700K Warm Dim to 2000K <b>30K</b> 3000K Warm White <b>30D</b> 3000K Warm Dim to 2000K <b>35K</b> 3500K Neutral White <b>40K</b> 4000K Cool White <b>57K</b> 5700K Daylight White <b>2K6K</b> Tunable White 2000K-6500K <b>27K6</b> Tunable White 2700K-6500K <b>RGB</b> Red, Green, Blue (5W only) <b>RRR</b> Red Static Color Monochromatic (5W only) <b>GGG</b> Green Static Color Monochromatic (5W only) <b>BBB</b> Blue Static Color Monochromatic (5W only) <b>AAA</b> Amber Static Color Monochromatic (5W only)	<b>SA</b> <b>BZ</b> Antique Bronze <b>SA</b> Satin Aluminum <b>WH</b> White

PROJECT	FIXTURE TYPE	DATE
---------	--------------	------

# LIGHT CHANNEL 45° ANGLED COMPLETE FIXTURE

24VDC SURFACE MOUNT LIGHT CHANNEL, STATIC WHITE & COLOR, TUNABLE WHITE, WARM DIM & RGB

REV 02.23.22

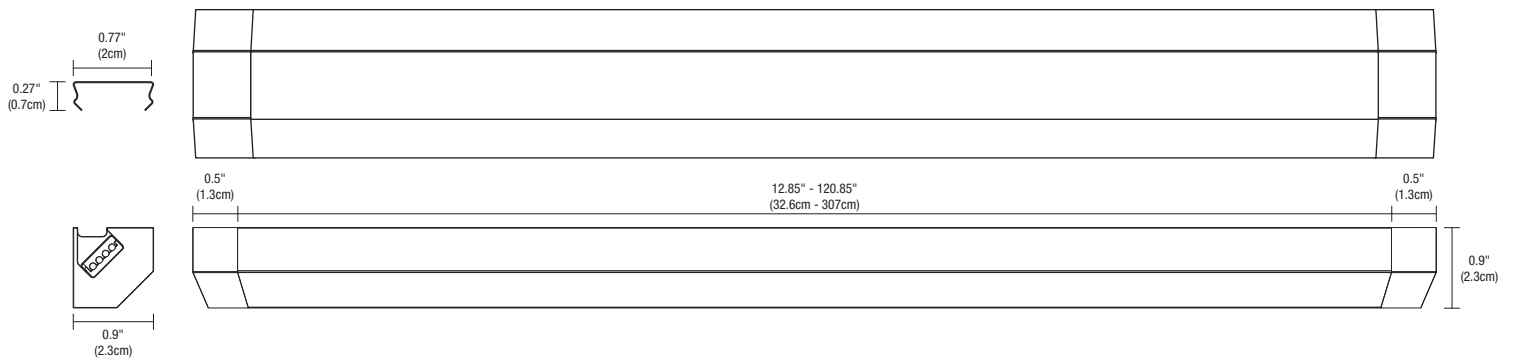

## INCLUDED COMPONENTS Lens Options and Lamp Data for indoor Light Channel 0.6" Surface Mount

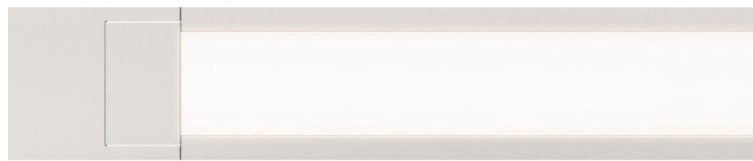

**LC45 LIGHT CHANNEL 61° DIFFUSED LENS**  
White Diffused Lens projects clean lines of light, eliminating LED dots



**LC45 LIGHT CHANNEL 26° CLEAR LENS**  
Clear Lens provides maximum light levels and will show slight LED dots



**LC45 LIGHT CHANNEL DIFFUSER LENS WITH GEL COLOR FILTER (PROVIDED BY CUSTOMER)**

Clear and Diffuser Lens are Gel Color Filter Suitable allowing for color personalization. Zircon LED Gel filters are recommended and can be purchased from [www.leafilters.com](http://www.leafilters.com). Gel filter life is 5,000 hours before needing to be changed

Lamp Life is 50,000 hours

WATTS PER FOOT	LIGHT CHANNEL 45° SURFACE MOUNT																						
	2w (2.5 watts)								5w (4.4 watts)								7w (7.5 watts)						
COLOR TEMPERATURE	22K	24K	27K	30K	35K	40K	57K	22K	24K	27K	27D*	30K	30D*	35K	40K	57K	22K	24K	27K	30K	35K	40K	57K
CLEAR LENS LUMENS PER FOOT (lm/ft)	141	141	142	148	170	179	190	260	260	263	300	274	313	315	332	351	402	402	407	423	486	512	542
CLEAR LENS LUMENS PER WATT (lm/w)	56	56	57	59	68	72	76	59	59	60	63	62	65	71	75	80	55	55	56	58	67	70	74
DIFFUSER LENS LUMENS PER FOOT (lm/ft)	120	120	121	127	145	153	162	222	222	225	256	234	267	268	283	299	343	343	347	361	415	437	463
DIFFUSER LENS LUMENS PER WATT (lm/w)	48	48	49	51	58	61	65	51	51	51	53	53	56	61	64	68	47	47	47	48	49	57	60
RF	83.9	85	87.7	88.1	86.1	87.6	80.3	83.9	85.2	87.7	89.9	88.1	89.7	86.1	87.6	80.3	83.9	85.2	87.7	88.1	86.1	87.6	80.3
RG	94.9	97.4	96.1	99.7	95.5	96.8	91.5	94.9	97.4	96.1	99.1	99.7	99.3	96.8	95.5	91.5	94.9	97.4	96.1	99.7	95.5	96.8	91.5
CRI	85+	90+	95+	95+	85+	85+	85+	85+	90+	95+	92+	95+	92+	85+	85+	85+	85+	90+	95+	95+	85+	85+	85+

WATTS PER FOOT	2K6K 2W (2.5 watts)										27K6 2W (2.5 watts)						2K6K 5W (4.6 watts)						27K6 5W (4.6 watts)									
	20K	22K	24K	27K	30K	35K	40K	57K	65K	27K	30K	35K	40K	45K	57K	65K	20K	22K	24K	27K	30K	35K	40K	57K	65K	27K	30K	35K	40K	45K	57K	65K
CLEAR LENS LUMENS PER FOOT (lm/ft)	75	76	77	79	80	82	89	96	103	82	97	99	102	112	120	114	182	190	197	205	212	227	243	246	248	256	263	271	279	268	265	257
CLEAR LENS LUMENS PER WATT (lm/w)	41	38	39	39	40	41	90	48	57	41	39	40	41	45	48	57	40	40	41	43	44	47	51	51	54	64	66	66	65	65	66	65
DIFFUSER LENS LUMENS PER FOOT (lm/ft)	64	65	66	67	68	70	76	82	88	70	83	85	87	95	102	98	156	162	168	175	181	194	208	210	212	218	225	231	238	229	226	219
DIFFUSER LENS LUMENS PER WATT (lm/w)	35	33	33	33	34	35	90	41	49	35	33	34	35	38	41	49	34	34	35	36	38	40	43	44	46	55	56	56	55	56	57	56
RF	91+	91+	91+	91+	91+	94+	94+	94+	91+	93+	93+	94+	94+	94+	93+	93+	90.1	90.1	90.1	90.1	90.1	90.1	90.5	86.6	86.6	90	90	89	89	89	87	87
RG	90.1	90.1	90.1	90.1	90.1	90.1	90.5	86.6	86.6	90	90	89	89	89	87	87	99	99	99	99	99	99	101	96	96	97	97	99	99	99	97	97
CRI	99.4	99.4	99.4	99.4	99.4	99.4	100.8	96.4	96.4	97	97	99	99	99	97	97	91+	91+	91+	91+	91+	94+	94+	94+	91+	93+	93+	94+	94+	94+	93+	93+

WATTS PER FOOT	2K6K 7W (7.3 watts)										27K6 7W (7.3 watts)					
	20K	22K	24K	27K	30K	35K	40K	57K	65K	27K	30K	35K	40K	45K	57K	65K
CLEAR LENS LUMENS PER FOOT (lm/ft)	254	266	278	290	301	325	343	346	350	298	305	316	327	324	321	320
CLEAR LENS LUMENS PER WATT (lm/w)	40	37	39	40	42	45	48	48	55	47	42	44	45	45	45	50
DIFFUSER LENS LUMENS PER FOOT (lm/ft)	217	227	237	247	257	278	292	295	298	254	260	270	279	276	274	273
DIFFUSER LENS LUMENS PER WATT (lm/w)	34	31	33	34	36	39	41	41	47	40	36	37	39	38	38	43
RF	90.1	90.1	90.1	90.1	90.1	90.1	90.5	86.6	86.6	90	90	90	89	88	88	88
RG	99.4	99.4	99.4	99.4	99.4	99.4	100.8	96.4	96.4	99	99	99	99	98	98	98
CRI	91+	91+	91+	91+	91+	94+	94+	94+	91+	93+	93+	94+	94+	94+	93+	93+

## FOOT CANDLE CHARTS

30K 100° 5W DIFFUSER LENS		
DISTANCE	BEAM	FOOT CANDLE
12"	29"	240
18"	43"	106
24"	57"	60
36"	86"	26

30K 40° 5W CLEAR LENS		
DISTANCE	BEAM	FOOT CANDLE
12"	8"	720
18"	13"	320
24"	18"	180
36"	26"	80

\*Foot Candle Data is based off 4' Channel.

PROJECT	FIXTURE TYPE	DATE
---------	--------------	------

# LIGHT CHANNEL 45° ANGLED COMPLETE FIXTURE

24VDC SURFACE MOUNT LIGHT CHANNEL, STATIC WHITE & COLOR, TUNABLE WHITE, WARM DIM & RGB

REV 02.23.22

**Included Components:** Light Channel 45° system overview

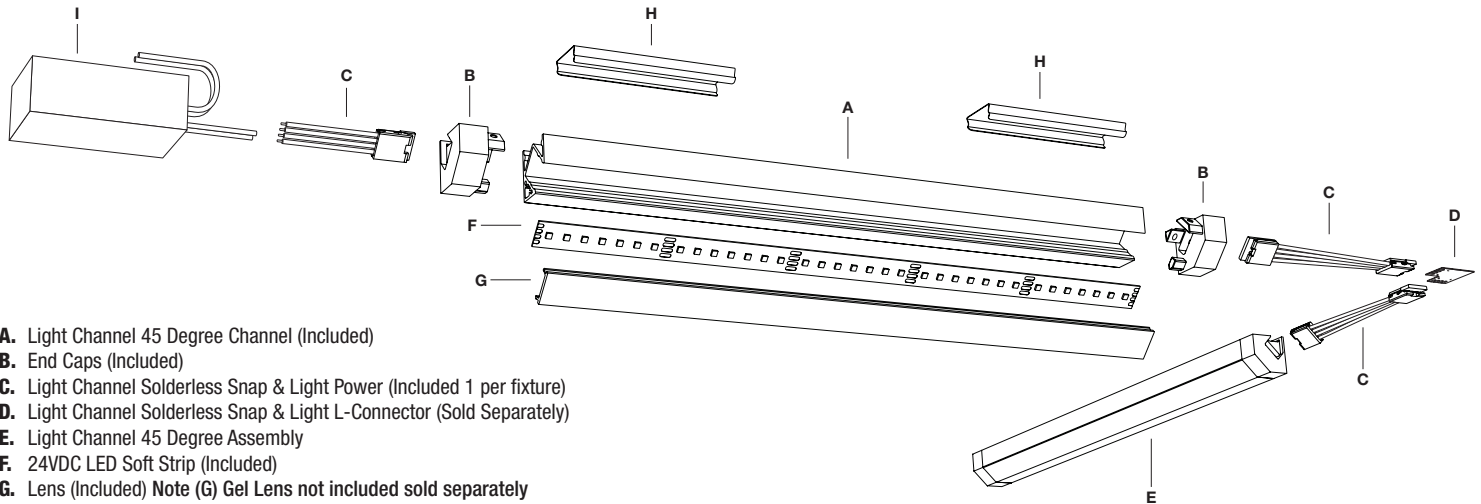

- A.** Light Channel 45 Degree Channel (Included)
- B.** End Caps (Included)
- C.** Light Channel Solderless Snap & Light Power (Included 1 per fixture)
- D.** Light Channel Solderless Snap & Light L-Connector (Sold Separately)
- E.** Light Channel 45 Degree Assembly
- F.** 24VDC LED Soft Strip (Included)
- G.** Lens (Included) **Note (G)** Gel Lens not included sold separately
- H.** Mounting Clips (Included with every 2' of channel)
- I.** Remote Power Supply (PSB-60W-ELV-24VDC shown) (Sold Separately)

**Wiring Diagram:** Electronic Low Voltage (ELV) dimming for Light Channel 45°

- Application:** Electronic low-voltage dimming for 45° Light Channel
- Power Supply:** 120VAC input, 24VDC 100 watt output PSB-100W-ELV-24VDC
- Dimming:** Dimmable with low voltage electronic dimmer using power supply above. See power supply spec sheet for additional details. Lutron: Diva DVELV-300P; Skylark SELV-300P; Maestro MAELV-600 dimmers are recommended.

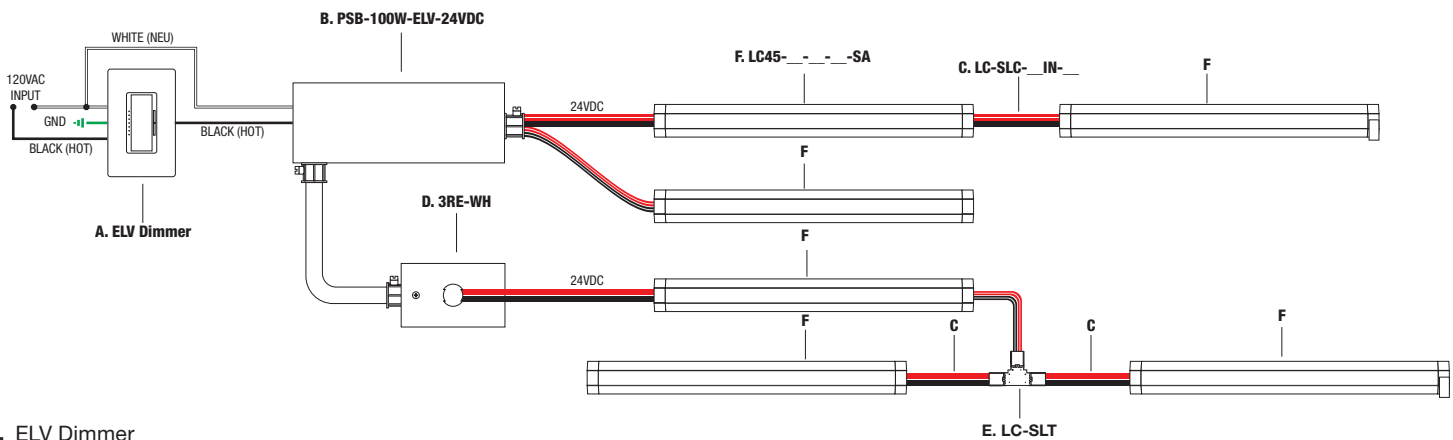

- A.** ELV Dimmer
- B.** 100W 24VDC Power Supply **PSB-100W-ELV-24VDC**
- C.** Snap & Light Power/Jumper Connector **LC-SLC-\_\_IN-\_\_**
- D.** 3" Rectangle Canopy Cover **3RE-WH**
- E.** Light Channel Snap & Light T Connector **LC-SLT**
- F.** Light Channel 45° Surface Mount **LC45-\_\_-\_\_-\_\_-SA**

PROJECT	FIXTURE TYPE	DATE
---------	--------------	------



# LIGHT CHANNEL 45° ANGLED COMPLETE FIXTURE

24VDC SURFACE MOUNT LIGHT CHANNEL, STATIC WHITE & COLOR, TUNABLE WHITE, WARM DIM & RGB



REV 02.23.22

**Length Charts:** Actual lengths for Light Channel 45°

STATIC WHITE					
Ordering Code (Nominal Size)	Illuminated Length (Inches)	Overall Length (Inches)	Ordering Code (Nominal Size)	Illuminated Length (Inches)	Overall Length (Inches)
12	12.0	13.0	68	67.2	68.2
15	14.4	15.4	70	69.6	70.6
17	16.8	17.8	72	72.0	73.0
20	19.2	20.2	75	74.4	75.4
22	21.6	22.6	77	76.8	77.8
24	24.0	25.0	80	79.2	80.2
27	26.4	27.4	82	81.6	82.6
29	28.8	29.8	84	84.0	85.0
32	31.2	32.2	87	86.4	87.4
34	33.6	34.6	89	88.8	89.8
36	36.0	37.0	92	91.2	92.2
39	38.4	39.4	94	93.6	94.6
41	40.8	41.8	96	96.0	97.0
44	43.2	44.2	99	98.4	99.4
46	45.6	46.6	101	100.8	101.8
48	48.0	49.0	104	103.2	104.2
51	50.4	51.4	106	105.6	106.6
53	52.8	53.8	108	108.0	109.0
56	55.2	56.2	111	110.4	111.4
58	57.6	58.6	113	112.8	113.8
60	60.0	61.0	116	115.2	116.2
63	62.4	63.4	118	117.6	118.6
65	64.8	65.8	120	120.0	121.0

27D, 30D WARM DIM					
Ordering Code (Nominal Size)	Illuminated Length (Inches)	Overall Length (Inches)	Ordering Code (Nominal Size)	Illuminated Length (Inches)	Overall Length (Inches)
12	12	13	69	69	70
15	15	16	72	72	73
18	18	19	75	75	76
21	21	22	78	78	79
24	24	25	81	81	82
27	27	28	84	84	85
30	30	31	87	87	88
33	33	34	90	90	91
36	36	37	93	93	94
39	39	40	96	96	97
42	42	43	99	99	100
45	45	46	102	102	103
48	48	49	105	105	106
51	51	52	108	108	109
54	54	55	111	111	112
57	57	58	114	114	115
60	60	61	117	117	118
63	63	64	120	120	121
66	66	67			

PROJECT		FIXTURE TYPE		DATE	
---------	--	--------------	--	------	--

# LIGHT CHANNEL 45° ANGLED COMPLETE FIXTURE

24VDC SURFACE MOUNT LIGHT CHANNEL, STATIC WHITE & COLOR, TUNABLE WHITE, WARM DIM & RGB

**Accessories:** Light Channel 45° order based on lighting design or as replacement parts

## 24VDC LIGHT CHANNEL SOLDERLESS SNAP & LIGHT JUMPER/POWER CONNECTOR

Power connector is included, may be ordered as a jumper connector. Join sections of Light Channel using Solderless Snap & Light L, T, or X Connectors below. To use as a power connector cut and strip the wires.

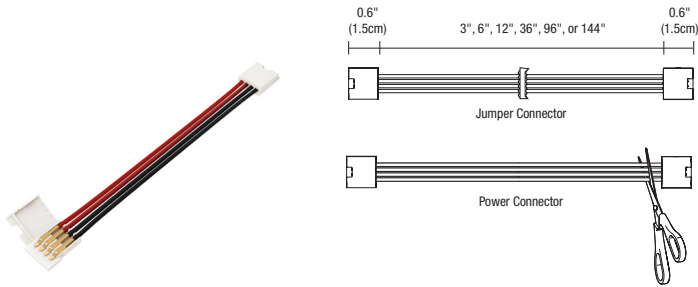

System	Product	Length
<b>LC</b>	<b>SLC</b>	<b>3IN</b>
LC Light Channel	SLC Solderless Snap & Light Jumper/Power Connector	<b>3IN</b> 3" <b>36IN</b> 36" <b>6IN</b> 6" <b>96IN</b> 96" <b>12IN</b> 12" <b>144IN</b> 144"

## LIGHT CHANNEL SOLDERLESS SNAP & LIGHT L-CONNECTOR

Conducts power to 2 sections of LED Soft Strip within the Light Channel. Requires Light Channel Solderless Snap & Light Power/Jumper Connector (sold separately) for use.

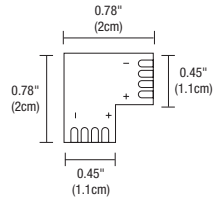
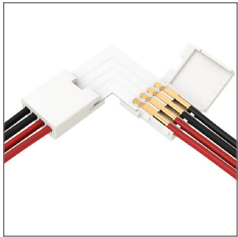

System	Product
<b>LC</b>	<b>SLL</b>
LC Light Channel	SLL Snap & Light L-Connector

## LIGHT CHANNEL SOLDERLESS SNAP & LIGHT T-CONNECTOR

Conducts power to 3 sections of LED Soft Strip within the Light Channel. Requires Light Channel Solderless Snap & Light Power/Jumper Connector for use (sold separately).

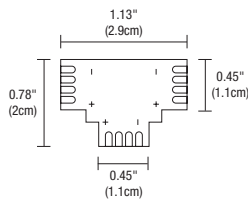
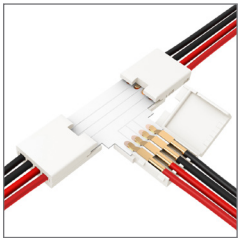

System	Product
<b>LC</b>	<b>SLT</b>
LC Light Channel	SLT Snap & Light T-Connector

## LIGHT CHANNEL SOLDERLESS SNAP & LIGHT X-CONNECTOR

Conducts power to 4 sections of LED Soft Strip within the Light Channel. Requires Light Channel Solderless Snap & Light Power/Jumper Connector for use (sold separately).

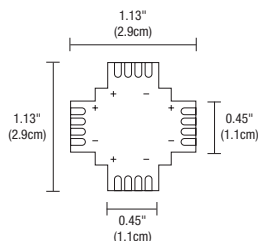
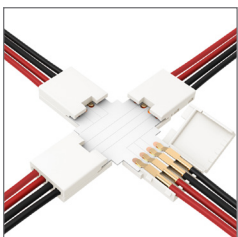

System	Product
<b>LC</b>	<b>SLX</b>
LC Light Channel	SLX Snap & Light X-Connector

PROJECT	FIXTURE TYPE	DATE
---------	--------------	------

# LIGHT CHANNEL 45° ANGLED COMPLETE FIXTURE

24VDC SURFACE MOUNT LIGHT CHANNEL, STATIC WHITE & COLOR, TUNABLE WHITE, WARM DIM & RGB

REV 02.23.22

**Accessories:** Light Channel 45° Order based on lighting design or as replacement parts.

## MOUNTING CLIP

Light Channel comes with standard mounting clips. LC45-MCL mounting clips are provided with every 2' of Light Channel.

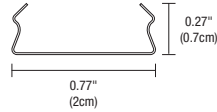
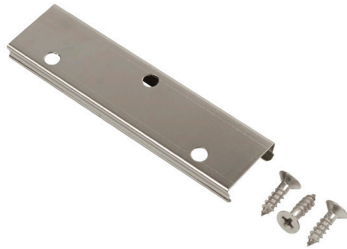

System	Product
<b>LC45</b>	<b>MCL</b>
LC45 Light Channel 45°	MCL Mounting Clip

## CANOPY COVER & SPLICE BOX

Use for remote located power supply. The 3" rectangle or 4" round white canopy covers the electrical box and feeds wires for Light Channel. The Splice Box provides a safe enclosure for low voltage connections.



**4RD-WH**

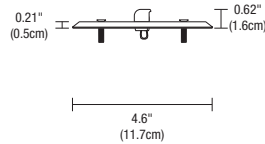
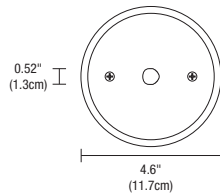

**3RE-WH**

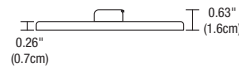
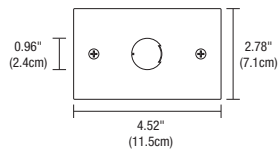

**1RB-WH**

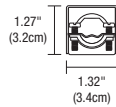
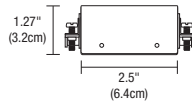

Product	Finish
<b>3RE</b>	<b>WH</b>
3RE 3" Rectangle Canopy Cover	WH White
4RD 4" Round Canopy Cover	
1RB 1" Rectangle Splice Box	

PROJECT	FIXTURE TYPE	DATE
---------	--------------	------



# TM30 DATA

24VDC SURFACE MOUNT LIGHT CHANNEL, STATIC WHITE & COLOR, TUNABLE WHITE, WARM DIM & RGB

**TM-30-15 DATA:** The data below is for SS2C, SS5C, SS7C, and SS10C bare LED Soft Strips. Consistent color temperatures throughout a single strip and among multiple strips is possible through a 3 phase binning process in which each order is inspected with a color meter to ensure uniformity.

**2200K** | Rf: 83.9 | Rg: 94.9

Color Vector Graphic

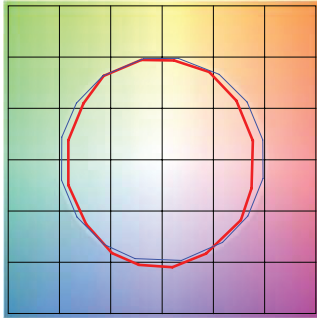

■ Test ■ Reference

HUE BIN	Rf	GRAPHIC SHIFTS %	
		CHROMA	HUE
1	78.8	-9.5%	1.3%
2	80.7	-7.8%	6.7%
3	78.2	-3.3%	9.4%
4	89.7	-2.8%	3.6%
5	93.2	-0.8%	2.6%
6	93.0	-0.6%	-0.7%
7	87.7	-5.9%	-3.5%
8	89.2	-6.8%	1.9%
9	83.4	-5.6%	6.0%
10	79.3	-3.7%	10.8%
11	81.4	2.9%	11.1%
12	84.9	5.3%	4.9%
13	88.1	4.9%	-10.1%
14	68.1	0.1%	-19.5%
15	86.0	-3.3%	-7.3%
16	76.4	-8.9%	-11.7%

**2400K** | Rf: 91.2 | Rg: 96.8

Color Vector Graphic

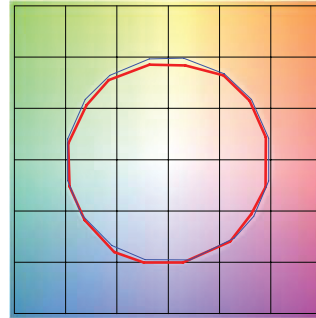

■ Test ■ Reference

HUE BIN	Rf	GRAPHIC SHIFTS %	
		CHROMA	HUE
1	92.0	-2.4%	1.5%
2	94.7	-2.1%	0.0%
3	95.4	-1.9%	-0.1%
4	88.7	-6.7%	-3.1%
5	92.8	-5.6%	1.0%
6	92.7	-3.4%	3.4%
7	89.9	-4.3%	4.1%
8	92.4	-1.4%	4.4%
9	89.0	-0.6%	5.8%
10	88.9	0.4%	6.2%
11	89.7	4.0%	5.4%
12	92.6	3.0%	-0.7%
13	90.9	1.1%	-7.0%
14	89.9	0.5%	-5.8%
15	92.1	-3.2%	0.1%
16	88.9	-1.7%	-6.3%

**2700K** | Rf: 87.7 | Rg: 96.1

Color Vector Graphic

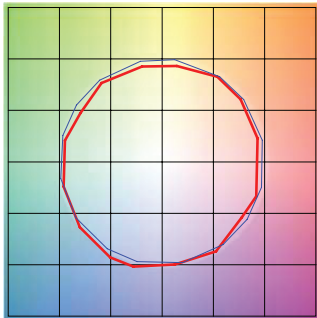

■ Test ■ Reference

HUE BIN	Rf	GRAPHIC SHIFTS %	
		CHROMA	HUE
1	88.0	-4.3%	2.6%
2	91.6	-2.4%	2.0%
3	93.7	-1.4%	1.9%
4	88.9	-5.6%	-3.1%
5	92.3	-5.5%	-0.5%
6	92.9	-3.5%	0.1%
7	84.5	-7.5%	4.6%
8	90.8	-3.0%	4.4%
9	84.5	-1.3%	8.3%
10	83.9	2.0%	9.8%
11	87.2	5.3%	7.1%
12	89.2	5.4%	-2.6%
13	88.7	0.3%	-7.8%
14	86.8	1.7%	-9.3%
15	87.6	-5.4%	-1.3%
16	83.6	-3.3%	-9.5%

**3000K** | Rf: 88.1 | Rg: 99.7

Color Vector Graphic

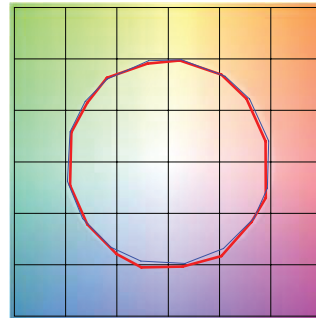

■ Test ■ Reference

HUE BIN	Rf	GRAPHIC SHIFTS %	
		CHROMA	HUE
1	92.5	-3.1%	0.3%
2	93.3	-2.3%	1.9%
3	90.9	-0.8%	3.9%
4	94.3	-1.1%	1.4%
5	92.5	-2.6%	1.5%
6	96.4	1.2%	-0.3%
7	92.6	-2.5%	-0.0%
8	96.9	-1.4%	0.2%
9	92.3	-1.8%	4.3%
10	86.6	-0.7%	7.0%
11	86.5	2.4%	8.2%
12	89.8	5.9%	1.7%
13	93.9	2.6%	-2.7%
14	89.4	5.1%	-5.8%
15	90.1	-0.1%	-4.7%
16	86.5	0.3%	-9.7%

**3500K** | Rf: 86.1 | Rg: 95.5

Color Vector Graphic

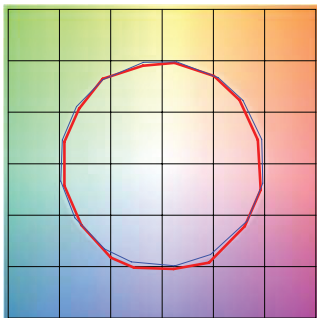

■ Test ■ Reference

HUE BIN	Rf	GRAPHIC SHIFTS %	
		CHROMA	HUE
1	90.8	-3.8%	0.3%
2	92.3	-2.8%	2.1%
3	89.7	-1.0%	4.3%
4	92.6	-1.4%	1.7%
5	91.8	-3.1%	1.3%
6	96.2	0.8%	-0.4%
7	92.9	-3.2%	0.2%
8	94.3	-2.5%	1.5%
9	90.4	-2.5%	5.2%
10	84.3	-1.4%	9.5%
11	83.1	3.5%	9.8%
12	88.2	4.8%	3.4%
13	94.0	2.7%	-2.0%
14	88.7	5.9%	-5.8%
15	88.7	0.7%	-5.9%
16	86.8	-0.7%	-6.7%

**4000K** | Rf: 87.6 | Rg: 96.8

Color Vector Graphic

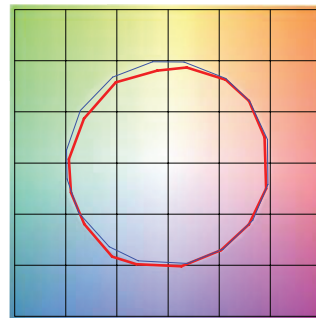

■ Test ■ Reference

HUE BIN	Rf	GRAPHIC SHIFTS %	
		CHROMA	HUE
1	88.9	-2.4%	2.5%
2	93.3	-0.4%	0.8%
3	94.8	-1.0%	-0.6%
4	87.9	-4.9%	-3.6%
5	85.3	-9.4%	-2.6%
6	90.2	-6.0%	0.2%
7	85.3	-7.6%	4.6%
8	83.7	-4.1%	8.2%
9	79.5	-1.1%	13.8%
10	78.6	1.5%	12.1%
11	83.5	6.4%	7.8%
12	90.9	3.6%	-1.1%
13	88.3	1.7%	-6.3%
14	91.9	-0.4%	-2.2%
15	84.5	-0.9%	-5.5%
16	84.7	-1.1%	-4.4%

PROJECT	FIXTURE TYPE	DATE
---------	--------------	------

# TM30 DATA

24VDC SURFACE MOUNT LIGHT CHANNEL, STATIC WHITE & COLOR, TUNABLE WHITE, WARM DIM & RGB

**TM-30-15 DATA:** The data below is for SS2C, SS5C, SS7C, and SS10C bare LED Soft Strips. Consistent color temperatures throughout a single strip and among multiple strips is possible through a 3 phase binning process in which each order is inspected with a color meter to ensure uniformity.

**5700K** | Rf: 80.3 | Rg: 91.5

Color Vector Graphic

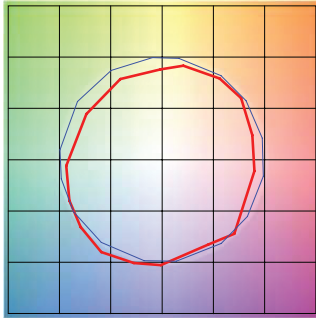

■ Test ■ Reference

HUE BIN	Rf	GRAPHIC SHIFTS %	
		CHROMA	HUE
1	75.4	-8.9%	4.7%
2	87.5	-2.6%	4.6%
3	90.7	-3.0%	-0.5%
4	83.2	-6.0%	-5.7%
5	76.2	-12.9%	-5.3%
6	81.4	-11.9%	-2.6%
7	74.8	-14.0%	5.1%
8	69.0	-9.0%	14.1%
9	72.6	-3.6%	22.2%
10	71.4	2.7%	16.1%
11	81.3	7.9%	5.3%
12	83.6	4.1%	-9.4%
13	78.4	0.7%	-15.3%
14	77.7	-6.2%	-11.0%
15	68.8	-1.3%	-21.2%
16	80.8	-9.6%	3.3%

**2700D** | Rf: 89.5 | Rg: 100.8

Color Vector Graphic

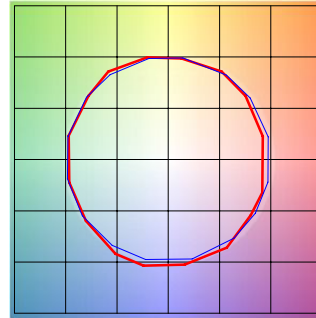

■ Test ■ Reference

HUE BIN	Rf	GRAPHIC SHIFTS %	
		CHROMA	HUE
1	88.8	-5.1%	1.4%
2	89.8	-2.7%	4.1%
3	87.2	0.3%	5.9%
4	92.3	-0.9%	1.0%
5	93.3	1.5%	1.7%
6	92.4	3.6%	-0.2%
7	92.2	-0.9%	-2.4%
8	96.7	-0.4%	-1.1%
9	92.3	-1.2%	3.7%
10	88.9	-0.0%	6.1%
11	86.4	5.1%	7.4%
12	88.2	6.3%	-0.9%
13	87.2	3.8%	-8.1%
14	84.2	3.8%	-11.0%
15	89.8	-2.6%	-4.3%
16	82.7	-3.4%	-11.1%

**3000D** | Rf: 89.8 | Rg: 101.4

Color Vector Graphic

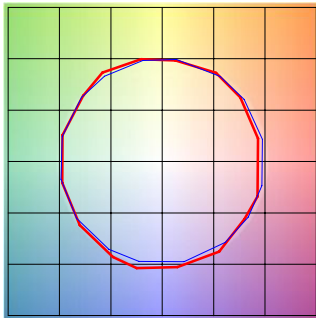

■ Test ■ Reference

HUE BIN	Rf	GRAPHIC SHIFTS %	
		CHROMA	HUE
1	90.2	-4.2%	1.5%
2	90.9	-2.0%	3.7%
3	87.9	0.8%	5.5%
4	92.1	-0.9%	0.6%
5	93.0	1.5%	1.6%
6	92.2	3.9%	-0.2%
7	92.1	-0.3%	-2.0%
8	96.7	0.0%	-1.2%
9	92.5	-0.6%	3.7%
10	88.3	1.1%	7.0%
11	87.2	4.1%	7.4%
12	87.2	6.7%	-1.0%
13	88.2	3.8%	-7.2%
14	85.3	4.3%	-9.9%
15	90.9	-2.2%	-3.6%
16	83.4	-2.2%	-11.2%

PROJECT	FIXTURE TYPE	DATE
---------	--------------	------