

LIGHT CHANNEL COMPLETE FIXTURE 0.6" SURFACE MOUNT

24VDC SURFACE MOUNT LIGHT CHANNEL, STATIC WHITE & COLOR, TUNABLE WHITE, WARM DIM & RGB

DESIGNED BY GREGORY KAY | ASSEMBLED IN AMERICA

REV 08.11.21



DESCRIPTION

Light Channel 0.6" Surface Mount System is a made-to-order complete fixture, purchased in nominal increments of 2", 3", 5", 8" and 10". Light Channels may be ordered from 12" all the way up to 120" (10'). For longer continuous runs, see DIY spec sheet.

FEATURES AND BENEFITS

- 24VDC LED Strip provides up to 94+ CRI values offers excellent |Designer Luxury Grade color rendering and fits inside a slim profile aluminum extrusion
- Low voltage up to 100 watt. Class 2 wiring, eliminates the need for conduit
- Power Consumption Options: 2.5W | 4.4W | 4.8W | 7.3W per foot
- 7 LEDs per cutting increment provides 87.5% efficiency compared to six LEDs at only 75%. Solid State Power Supply offer 85-90% efficiency compared to magnetic at 80%. The combination of seven LEDs and a Solid State Power Supply increases the efficiency up to 22%.

LENS OPTIONS

- Clear Lens (**C**) provides maximum illumination use of a 40° transparent clear lens, LEDs diodes will show
- Clear Lens White Louver (**CLW**)
- Clear Lens Black Louver (**CLB**)
- Diffused White Lens (**D**) projects clean lines of light 100° eliminating pixelation
- Diffused Lens White Louver (**DLW**)
- Diffused Lens Black Louver (**DLB**)
- Diffused Lens with Gel Color Filter (**G**) (Provided by Customer) Clear and Diffuser Lens are Gel Color Filter Suitable allowing for color personalization. Zircon LED Gel filters recommended. Purchase Gel Lens from www.leefilters.com. See manufacturer spec sheet for more information.

INCLUDED COMPONENTS

- 96" of Solderless Snap & Light Power Connector (Includes 1 per fixture. Order extra as needed based on your installation requirements.)
- Mounting Clips (Included with every 2' of Channel)

ACCESSORIES (SOLD SEPARATELY)

- Mounting Clips (Included with every 2' of Channel)
- Solderless Snap & Light Power/Jumper Connector
- Solderless Light Channel Connectors L, T & X

REMOTE POWER SUPPLIES*, DIMMERS & CONTROLS (SOLD SEPARATELY)

- UNI Driver: Universal Dimming (**TRIAC, ELV, 0-10V**) with corresponding dimmer
- 0-10V dimming with 0-10V remote power supplies
- Lutron Hi-Lume®
- Electronic Low Voltage Dimming (**ELV**)[†]
- Dynamic Color Changing (**DMX**)

*In-Wall Mounting Kits available for select power supplies

**Tunable White - Requires two dimmers or use our proprietary Tunable White Controller CDMX-1 (page 6).

†With N-Lite Dimming Do Not use ELV power supplies, use only 0-10 volt or Uni drivers power supplies.

APPLICATIONS

Indoor Only - Hospitality, Restaurants, Retail, Display Cabinet Lighting, Under Cabinet Lighting, Above Cabinet Up-Lighting, Toe Kick, Cove, Night Clubs, General Lighting, Warm Dim/Dim-to-Warm, Tunable White, Human Centric Lighting

Product	Wattage	Nominal Size	Lens/Color Temperature				Finish
LCS.6	2W	60	D	22K			SA
LCS.6 Light Channel .6 Surface Mount	2W 2.5 watts 5W 4.4 watts 7W 7.3 watts	12-120 Order in 12" increments up to 120". May be ordered in 3, 5, 8 or 10" increments	D Diffused Lens C Clear Lens DLW Diffused Lens with White Louver DLB Diffused Lens with Black Louver CLB Clear Lens with Black Louver CLW Clear Lens with White Louver G Diffused Lens with Gel Color (Provided by Customer)	20K 2000K Sunset 22K 2200K Amber White 24K 2400K Very Warm White 27K 2700K Incandescent White 27D 2700K Warm Dim to 2000K (Dim-To-Warm) 5 Watt Only 30K 3000K Warm White 30D 3000K Warm Dim to 2000K (Dim-To-Warm) 5 Watt Only 35K 3500K Neutral White	40K 4000K Cool White 57K 5700K Daylight White 2K6K Tunable White 2000K-6500K 27K6 Tunable White 2700K-6500K RGB Red, Green, Blue (5W only) RRR Red Static Color Monochromatic (5W only) GGG Green Static Color Monochromatic (5W only) BBB Blue Static Color Monochromatic (5W only) AAA Amber Static Color Monochromatic (5W only)	SA Satin Aluminum XX Custom Finishes Available	
PROJECT	FIXTURE TYPE			DATE			

LIGHT CHANNEL COMPLETE FIXTURE 0.6" SURFACE MOUNT

24VDC SURFACE MOUNT LIGHT CHANNEL, STATIC WHITE & COLOR, TUNABLE WHITE, WARM DIM & RGB

REV 08.11.21

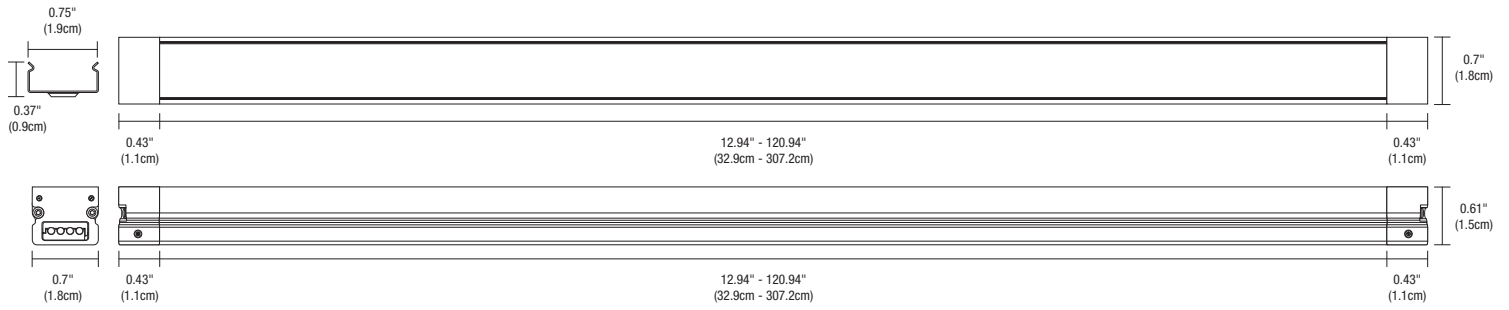

INCLUDED COMPONENTS Lens Options and Lamp Data for indoor Light Channel 0.6" Surface Mount

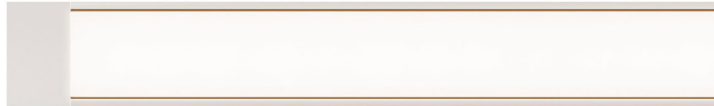

LCS.6 LIGHT CHANNEL 61° DIFFUSED LENS White Diffuser Lens projects clean lines of light, eliminating LED dots



LCS.6 LIGHT CHANNEL 26° CLEAR LENS Clear Lens provides maximum light levels and will show slight LED dots



LCS.6 LIGHT CHANNEL DIFFUSED WHITE LENS WITH WHITE LOUVER



LCS.6 LIGHT CHANNEL DIFFUSED LENS WITH BLACK LOUVER



LCS.6 LIGHT CHANNEL CLEAR LENS WITH WHITE LOUVER



LCS.6 LIGHT CHANNEL CLEAR LENS WITH BLACK LOUVER



LCS.6 LIGHT CHANNEL DIFFUSED LENS WITH GEL COLOR FILTER (PROVIDED BY CUSTOMER)

Clear and Diffuser Lens are Gel Color Filter Suitable allowing for color personalization. Zircon LED Gel filters are recommended and can be purchased from www.leefilters.com. Gel filter life is 5,000 hours before needing to be changed

Lamp Life is 50,000 hours

FOOT CANDLE CHARTS

30K 100° 5W DIFFUSED LENS		
DISTANCE	BEAM	FOOT CANDLE
12"	29"	240
18"	43"	106
24"	57"	60
36"	86"	26

30K 40° 5W CLEAR LENS		
DISTANCE	BEAM	FOOT CANDLE
12"	8"	720
18"	13"	320
24"	18"	180
36"	26"	80

*Foot Candle Data is based off 4' Channel.

PROJECT	FIXTURE TYPE	DATE
---------	--------------	------

LIGHT CHANNEL COMPLETE FIXTURE 0.6" SURFACE MOUNT

24VDC SURFACE MOUNT LIGHT CHANNEL, STATIC WHITE & COLOR, TUNABLE WHITE, WARM DIM & RGB

REV 08.11.21

BLACK LOUVER CLEAR FROSTED																																								
WATTS PER FOOT	2W (2.5 watts)							5W (4.4 watts)							7W (7.3 watts)							2K6K 2W (2.5 watts)					27K6 2W (2.5 watts)													
COLOR TEMPERATURE	22K	24K	27K	30K	35K	40K	57K	22K	24K	27K	27D*	30K	30D*	35K	40K	57K	22K	24K	27K	30K	35K	40K	57K	20K	22K	24K	27K	30K	35K	40K	57K	27K	30K	35K	40K	45K	57K	65K		
LUMENS PER FOOT (lm/ft)	53	53	54	56	64	68	72	99	99	100	114	104	118	119	125	133	152	152	154	160	184	194	205	29	29	29	30	30	31	34	36	39	31	37	38	39	42	45	43	
LUMENS PER WATT (lm/w)	21	21	22	22	26	27	29	22	22	23	24	24	25	27	29	30	21	21	21	22	25	27	28	15	14	15	15	15	15	15	90	18	22	15	15	15	15	17	18	22
CRI	85+	90+	95+	95+	85+	85+	85+	90+	95+	92+	95+	92+	85+	85+	85+	85+	90+	95+	95+	85+	85+	85+	85+	91+	92+	92+	94+	94+	93+	92+	91+	91+	94+	94+	94+	91+	91+	91+	91+	

*27D, 30D - Warm Dim (4.8 Watts)

BLACK LOUVER CLEAR FROSTED																																	
WATTS PER FOOT	2K6K 5W (4.4 watts)							27K6 5W (4.4 watts)							2K6K 7W (7.3 watts)							27K6 7W (7.3 watts)											
COLOR TEMPERATURE	20K	22K	24K	27K	30K	35K	40K	57K	65K	27K	30K	35K	40K	45K	57K	65K	20K	22K	24K	27K	30K	35K	40K	57K	65K	27K	30K	35K	40K	45K	57K	65K	
LUMENS PER FOOT (lm/ft)	69	72	75	77	80	86	92	93	94	97	100	103	105	101	100	97	96	101	105	110	114	123	130	131	132	113	115	120	124	122	121	121	
LUMENS PER WATT (lm/w)	15	15	16	16	17	18	19	19	20	20	24	25	25	25	25	25	15	14	15	15	16	17	18	18	21	18	16	17	17	17	17	19	
CRI	91+	92+	92+	94+	94+	93+	92+	91+	91+	94+	94+	94+	91+	91+	91+	91+	91+	92+	92+	94+	94+	93+	92+	91+	91+	91+	94+	94+	94+	91+	91+	91+	91+

BLACK LOUVER DIFFUSED																																								
WATTS PER FOOT	2W (2.5 watts)							5W (4.4 watts)							7W (7.3 watts)							2K6K 2W (2.5 watts)					27K6 2W (2.5 watts)													
COLOR TEMPERATURE	22K	24K	27K	30K	35K	40K	57K	22K	24K	27K	27D*	30K	30D*	35K	40K	57K	22K	24K	27K	30K	35K	40K	57K	20K	22K	24K	27K	30K	35K	40K	57K	27K	30K	35K	40K	45K	57K	65K		
LUMENS PER FOOT (lm/ft)	45	45	46	48	55	58	61	84	84	85	97	88	101	102	107	113	130	130	131	137	157	165	175	24	25	25	25	26	26	29	31	33	26	31	32	33	36	39	37	
LUMENS PER WATT (lm/w)	18	18	18	19	22	23	25	19	19	19	20	20	21	23	24	26	18	18	18	19	21	23	24	13	12	13	13	13	13	90	16	18	13	12	13	13	14	16	18	13
CRI	85+	90+	95+	95+	85+	85+	85+	90+	95+	92+	95+	92+	85+	85+	85+	85+	90+	95+	95+	85+	85+	85+	85+	91+	92+	92+	94+	94+	93+	92+	91+	91+	94+	94+	94+	91+	91+	91+	91+	

*27D, 30D - Warm Dim (4.8 Watts)

BLACK LOUVER DIFFUSED																																
WATTS PER FOOT	2K6K 5W (4.4 watts)							27K6 5W (4.4 watts)							2K6K 7W (7.3 watts)							27K6 7W (7.3 watts)										
COLOR TEMPERATURE	20K	22K	24K	27K	30K	35K	40K	57K	65K	27K	30K	35K	40K	45K	57K	65K	20K	22K	24K	27K	30K	35K	40K	57K	65K	27K	30K	35K	40K	45K	57K	65K
LUMENS PER FOOT (lm/ft)	59	61	64	66	68	73	79	79	80	83	85	88	90	87	86	83	82	86	90	93	97	105	111	112	113	96	98	102	106	104	104	103
LUMENS PER WATT (lm/w)	13	13	13	14	14	15	16	17	17	21	21	21	21	21	21	21	13	12	12	13	14	15	15	16	18	15	14	14	15	15	14	16
CRI	91+	92+	92+	94+	94+	93+	92+	91+	91+	94+	94+	94+	91+	91+	91+	91+	92+	92+	94+	94+	93+	92+	91+	91+	94+	94+	94+	91+	91+	91+	91+	91+

Length Charts: Actual lengths for Light Channel .6 Surface Mount

22K, 24K, 27K, 30K, 35K, 40K, 57K & TUNABLE WHITE								
Ordering Code (Nominal Size)	Illuminated Length (Inches)	Overall Length (Inches)	Ordering Code (Nominal Size)	Illuminated Length (Inches)	Overall Length (Inches)	Ordering Code (Nominal Size)	Illuminated Length (Inches)	Overall Length (Inches)
12	12.0	12.9	51	50.4	51.3	87	86.4	87.3
15	14.4	15.3	53	52.8	53.7	89	88.8	89.7
17	16.8	17.7	56	55.2	56.1	92	91.2	92.1
20	19.2	20.1	58	57.6	58.5	94	93.6	94.5
22	21.6	22.5	60	60.0	60.9	96	96.0	96.9
24	24.0	24.9	63	62.4	63.3	99	98.4	99.3
27	26.4	27.3	65	64.8	65.7	101	100.8	101.7
29	28.8	29.7	68	67.2	68.1	104	103.2	104.1
32	31.2	32.1	70	69.6	70.5	106	105.6	106.5
34	33.6	34.5	72	72.0	72.9	108	108.0	108.9
36	36.0	36.9	75	74.4	75.3	111	110.4	111.3
39	38.4	39.3	77	76.8	77.7	113	112.8	113.7
41	40.8	41.7	80	79.2	80.1	116	115.2	116.1
44	43.2	44.1	82	81.6	82.5	118	117.6	118.5
46	45.6	46.5	84	84.0	84.9	120	120.0	120.9
48	48.0	48.9						

27D, 30D WARM DIM								
Ordering Code (Nominal Size)	Illuminated Length (Inches)	Overall Length (Inches)	Ordering Code (Nominal Size)	Illuminated Length (Inches)	Overall Length (Inches)	Ordering Code (Nominal Size)	Illuminated Length (Inches)	Overall Length (Inches)
12	12.0	12.9	51	51.0	51.9	87	87.0	87.9
15	15.0	15.9	54	54.0	54.9	90	90.0	90.9
18	18.0	18.9	57	57.0	57.9	93	93.0	93.9
21	21.0	21.9	60	60.0	60.9	96	96.0	96.9
24	24.0	24.9	63	63.0	63.9	99	99.0	99.9
27	27.0	27.9	66	66.0	66.9	102	102.0	102.9
30	30.0	30.9	69	69.0	69.9	105	105.0	105.9
33	33.0	33.9	72	72.0	72.9	108	108.0	108.9
36	36.0	36.9	75	75.0	75.9	111	111.0	111.9
39	39.0	39.9	78	78.0	78.9	114	114.0	114.9
42	42.0	42.9	81	81.0	81.9	117	117.0	117.9
45	45.0	45.9	84	84.0	84.9	120	120.0	120.9
48	48.0	48.9						

PROJECT		FIXTURE TYPE		DATE	
---------	--	--------------	--	------	--

Wiring Diagram: 0-10 Volt (0-10V) dimming for Light Channel .6 Surface Mount

Power Supply: Class 2, 24VDC output: 120-277VAC input, 96 watt output PSB-96W-010-24VDC; 120-277VAC input, 192 watt output PSB-2X96W-010-24VDC

Dimming: Dimmable with 0-10V dimmer using power supply above. See power supply spec sheet for additional details. Philips Sunrise SR1200ZTUNV 0-10V dimmer recommended.

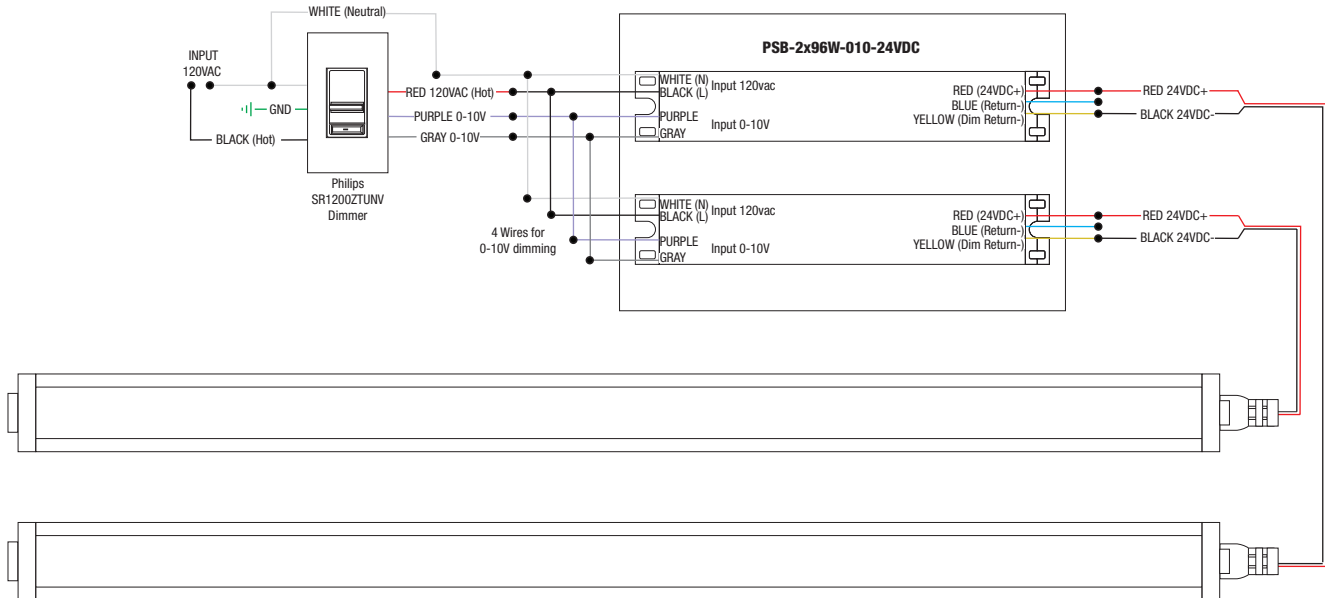
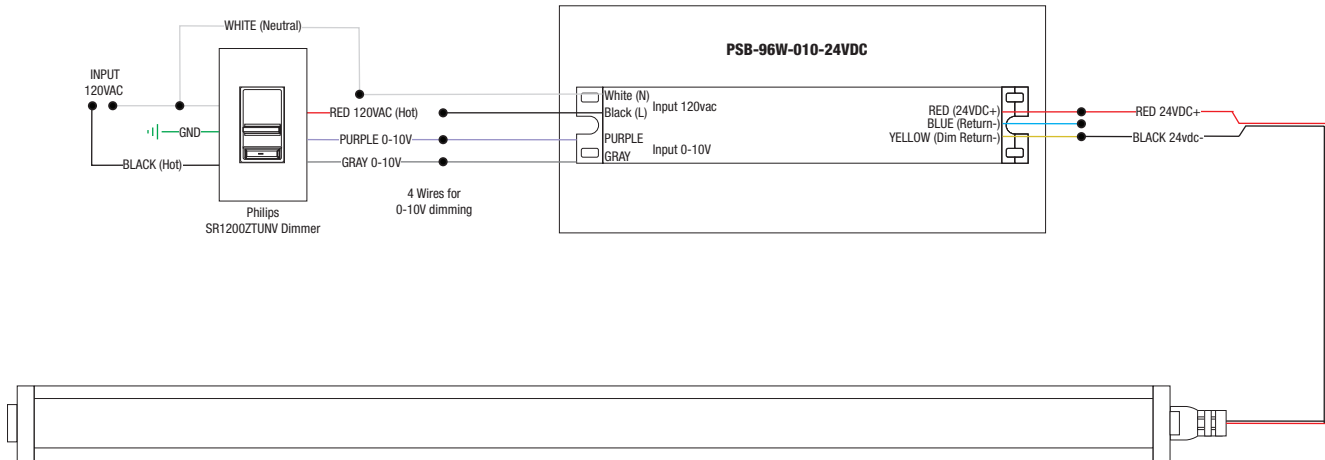

PROJECT		FIXTURE TYPE		DATE	
---------	--	--------------	--	------	--

LIGHT CHANNEL COMPLETE FIXTURE 0.6" SURFACE MOUNT

24VDC SURFACE MOUNT LIGHT CHANNEL, STATIC WHITE & COLOR, TUNABLE WHITE, WARM DIM & RGB

Included Components: Light Channel .6 Surface Mount system overview

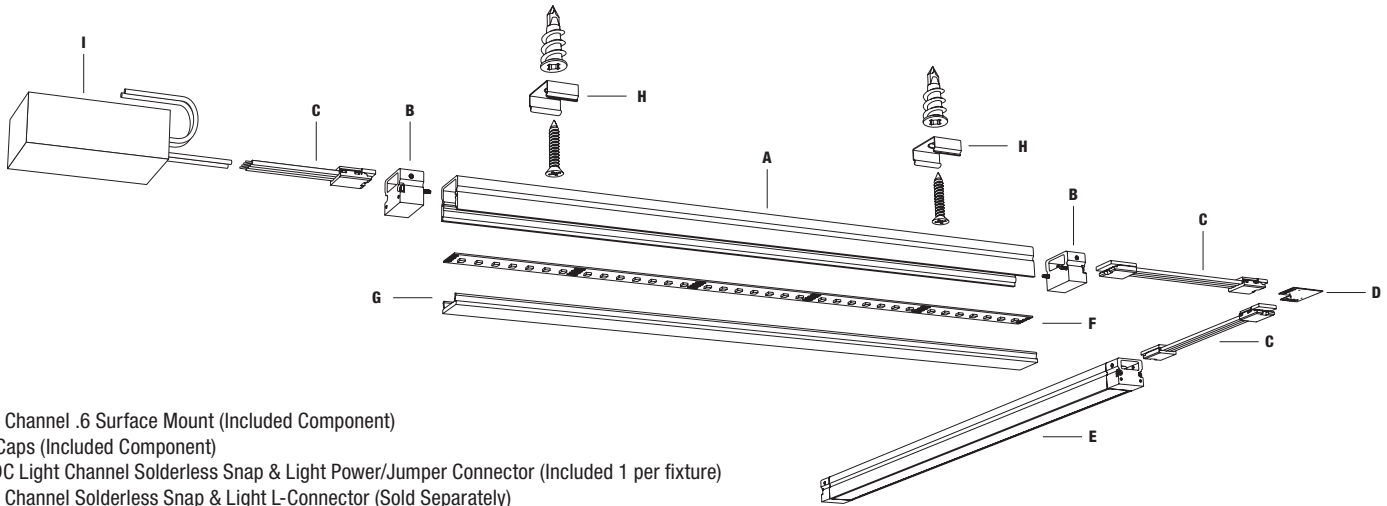

- A. Light Channel .6 Surface Mount (Included Component)
- B. End Caps (Included Component)
- C. 24VDC Light Channel Solderless Snap & Light Power/Jumper Connector (Included 1 per fixture)
- D. Light Channel Solderless Snap & Light L-Connector (Sold Separately)
- E. Light Channel .6 Surface Mount Assembly (Included Component)
- F. 24VDC LED Soft Strip (Included Component)
- G. Lens (Included Component)
- H. Mounting Clips (Included Component with every 2' of channel)
- I. Remote Power Supply (PSB-60L-ELV-24VDC shown) (Sold Separately)

Wiring Diagram: Electronic Low Voltage (ELV) dimming for Indoor Light Channel .6 Surface Mount

Power Supply: 120VAC input, 24VDC 96 watt output PSB-100W-ELV-24VDC

Dimming: Dimmable with low voltage electronic dimmer using power supply above. See power supply spec sheet for additional details.

Lutron: Diva DVELV-300P; Skylark SELV-300P; Maestro MAELV-600 dimmers are recommended.

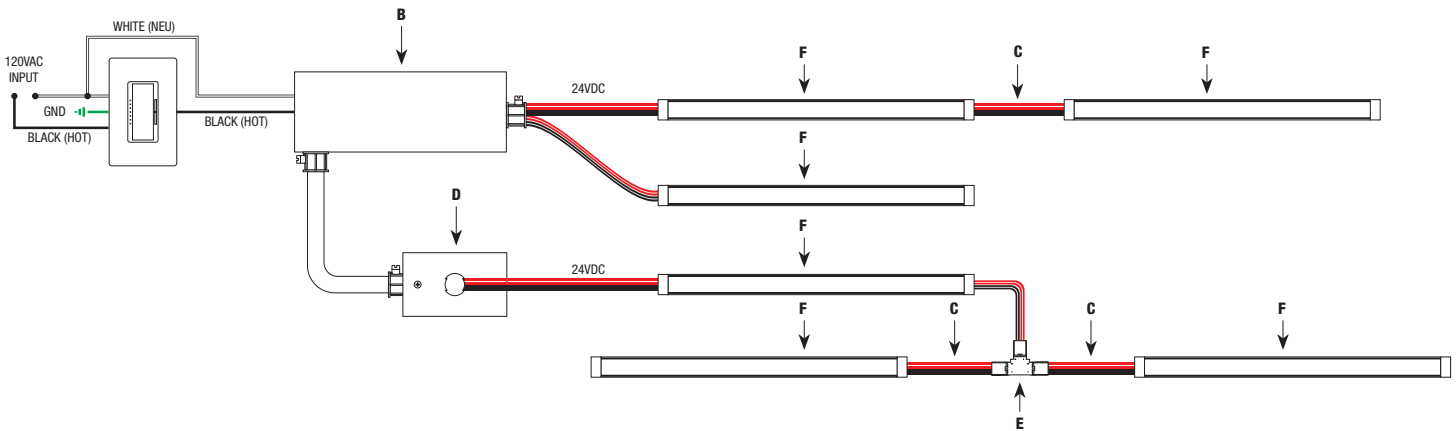

- A. ELV Dimmer
- B. 100W 24VDC Power Supply
- C. 24VDC Light Channel Solderless Snap & Light Power/Jumper Connector
- D. 3" Rectangle Canopy Cover
- E. Light Channel Solderless Snap & Light T Connector (LC-SLT)
- F. Light Channel .6 Surface Mount

PROJECT	FIXTURE TYPE	DATE
---------	--------------	------

Accessories: Indoor Light Channel .6 Surface Mount, order based on lighting design or as replacement parts

24VDC LIGHT CHANNEL SOLDERLESS SNAP & LIGHT JUMPER/POWER CONNECTOR

Power connector is included, may be ordered as a jumper connector. Join sections of Light Channel using Solderless Snap & Light L, T, or X Connectors below. To use as a power connector cut and strip the wires.

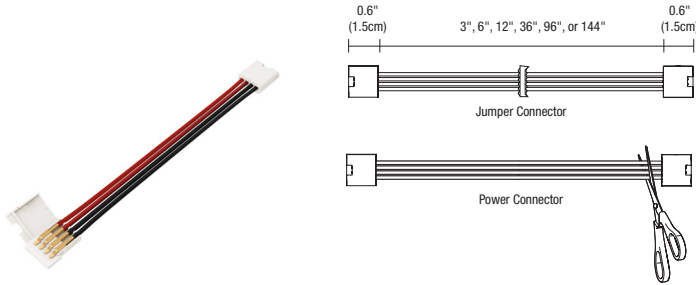

System	Product	Length			
LC	SLC	3IN			
LC Light Channel	SLC Solderless Snap & Light Jumper/Power Connector	3IN 3 Inches	6IN 6 Inches	36IN 36 Inches	96IN 96 Inches
		12IN 12 Inches	144IN 144 Inches		

LIGHT CHANNEL SOLDERLESS SNAP & LIGHT L-CONNECTOR

Conducts power to 2 sections of LED Strip within the Light Channel. Requires Light Channel Solderless Snap & Light Power/Jumper Connector (sold separately) for use.

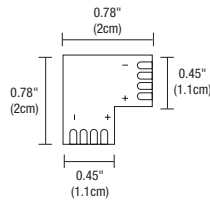
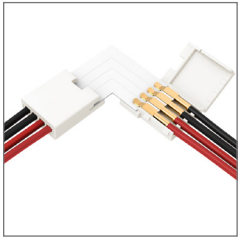

System	Product
LC	SLL
LC Light Channel	SLL Snap & Light L-Connector

LIGHT CHANNEL SOLDERLESS SNAP & LIGHT T-CONNECTOR

Conducts power to 3 sections of LED Strip within the Light Channel. Requires Light Channel Solderless Snap & Light Power/Jumper Connector for use (sold separately).

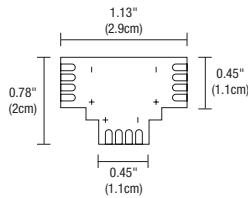
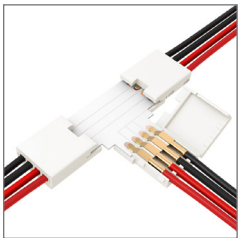

System	Product
LC	SLT
LC Light Channel	SLT Snap & Light T-Connector

LIGHT CHANNEL SOLDERLESS SNAP & LIGHT X-CONNECTOR

Conducts power to 4 sections of LED Strip within the Light Channel. Requires Light Channel Solderless Snap & Light Power/Jumper Connector for use (sold separately).

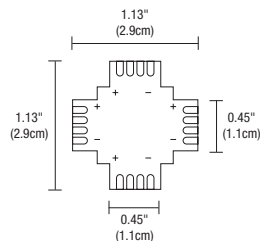
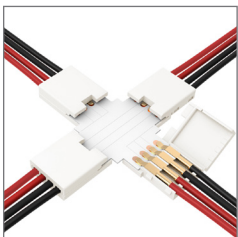

System	Product
LC	SLX
LC Light Channel	SLX Snap & Light X-Connector

PROJECT	FIXTURE TYPE	DATE
---------	--------------	------

Accessories: Indoor Light Channel .6 Surface Mount, order based on lighting design or as replacement parts



LCS.6-MCL

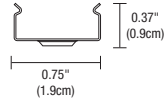

LCS.6-MCL

MOUNTING CLIPS

LC-MCL mounting clips are provided with every 2' of Light Channel and may be ordered separately as replacement parts. The LC-MCL-075 rotates Light Channel up to 75 degrees. LC-MCL-90 mounts Light Channel at a 90 degree angle.

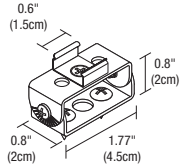

LCS.6-MCL-075

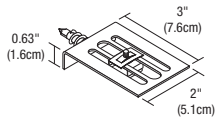

LCS.6-MCL-90

System	Product	Type
LCS.6	MCL	Standard (Leave Blank)
LCS.6 Light Channel 0.6" Surface Mount	MCL Mounting Clip	075 Adjusts 0-75° 90 Adjusts 90°

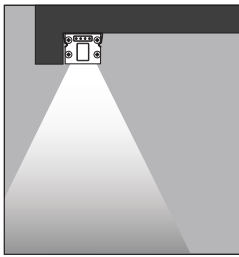

SHOWN WITH LCS.6-MCL

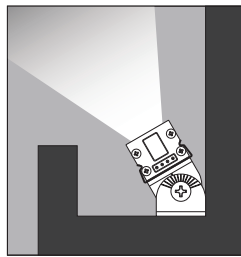

SHOWN WITH LCS.6-MCL-075

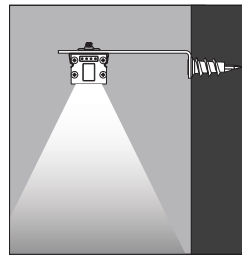

SHOWN WITH LCS.6-MCL-90



4RD-WH

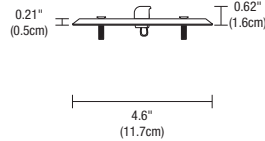
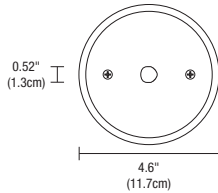

CANOPY COVER & SPLICE BOX

Use for remote located power supply. The 3 inch rectangle or 4 inch round white canopy covers the electrical box and feeds wires for Light Channel. The Splice Box provides a safe enclosure for low voltage connections.



3RE-WH

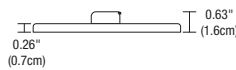
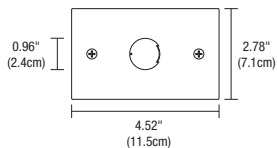

Product	Finish
3RE	WH
3RE 3" Rectangle Canopy Cover	WH White
4RD 4" Round Canopy Cover	

PROJECT	FIXTURE TYPE	DATE
---------	--------------	------

INDOOR CONSTANT VOLTAGE REMOTE POWER SUPPLIES

24VDC, UNIVERSAL DIMMING WITH ELV, TRIAC, & 0-10V FOR STATIC WHITE, WARM DIM

UNIVERSAL POWER SUPPLIES & RECOMMENDED DIMMERS

ORDERING CODE	PSB-40W-UNI-24VDC 	PSB-60W-UNI-24VDC 	PSB-2X40W-UNI-24VDC 	PSB-2X60W-UNI-24VDC
SPECIFICATIONS				
MAXIMUM LOAD	40W	60W	2X40W	2X60W
INPUT VOLTAGE	120-277VAC	120-277VAC	120-277VAC	120-277VAC
OUTPUT VOLTAGE	24VDC	24VDC	24VDC	24VDC
DIMENSIONS	12.4" X 3.12" X 2.18"	12.4" X 3.12" X 2.18"	12.15" X 6.48" X 2.18"	12.15" X 6.48" X 2.18"
CLASSIFICATION	CLASS 2	CLASS 2	CLASS 2	CLASS 2
T-BAR MOUNTING	PSB-40W-UNI-24VDC-TB	PSB-60W-UNI-24VDC-TB	PSB-2X40W-UNI-24VDC-TB	PSB-2X60W-UNI-24VDC-TB
IN-WALL MOUNTING	PSB-40W-UNI-24VDC-IW	PSB-60W-UNI-24VDC-IW	PSB-2X40W-UNI-24VDC-IW	PSB-2X60W-UNI-24VDC-IW

UNIVERSAL POWER SUPPLIES & RECOMMENDED DIMMERS

ORDERING CODE	PSB-96W-UNI-24VDC 	PSB-2X96W-UNI-24VDC 	PSB-3X96W-UNI-24VDC 	PSB-4X96W-UNI-24VDC
SPECIFICATIONS				
MAXIMUM LOAD	96W	2X96W	3X96W	4X96W
INPUT VOLTAGE	120-277VAC	120-277VAC	120-277VAC	120-277VAC
OUTPUT VOLTAGE	24VDC	24VDC	24VDC	24VDC
DIMENSIONS	12.4" X 3.12" X 2.18"	12.15" X 6.48" X 2.18"	14" X 10" X 3"	17" X 13" X 3"
CLASSIFICATION	CLASS 2	CLASS 2	CLASS 2	CLASS 2
T-BAR MOUNTING	PSB-96W-UNI-24VDC-TB	PSB-2X96W-UNI-24VDC-TB	PSB-3X96W-UNI-24VDC-TB	PSB-4X96W-UNI-24VDC-TB
IN-WALL MOUNTING	PSB-96W-UNI-24VDC-IW	PSB-2X96W-UNI-24VDC-IW	NA	NA

ELV DIMMING & CONTROLS

LUTRON DIVA: DVELV-300P	•	•	•	•
LUTRON SKYLARK: SELV-300P	•	•	•	•
LUTRON RADIO RA2: RRD-6NA	•	•	•	•
LUTRON MAESTRO: MAELV-600	•	•	•	•
LEGRAND ADORNE: ADTP-703TUM4	•	•	•	•

0-10 DIMMING & CONTROLS

PHILIPS SUNRISE: SR1200ZTUNV	•	•	•	•
LUTRON DIVA: DVTW-WH, DVSTV-WH	•	•	•	•
LUTRON NOVA T: NTSTV-DV-XX	•	•	•	•
LUTRON GRAFIX EYE QS: QSGRJ-XP	•	•	•	•
LUTRON RADIO RA2: RRD-10ND	•	•	•	•
LEVITON: LEV40050	•	•	•	•
LEVITON IP710-LFZ	•	•	•	•
LEGRAND: ADPD4FBL3P2W4	•	•	•	•

TRIAC DIMMING & CONTROLS

LUTRON SKYLARK: S2-L-WH	•	•	•	•
LUTRON DIVA DVLV-600P-WH	•	•	•	•
LUTRON DIVA DVLV-603P-WH	•	•	•	•
LUTRON MAESTRO MALV-600-WH	•	•	•	•
LUTRON MAESTRO MALV-1000-WH	•	•	•	•
LUTRON MAESTRO MA-R-XX	•	•	•	•

- Flicker free dimming
- Aluminum casing for optimal heat dissipation
- Isolated output power per NEC and UL safety requirements
- UL & ETL recognized/ listed, meets UL 8750, 1310 requirements
- Auto-reset; short circuit, overload and thermal protection
- Class 2 power supply
- Efficient, High power factor > 0.90

*Title 24 with JAB listed PureEdge products and systems

*Tunable White requires Dual power Supplies and Controls. For single control use with our proprietary Tunable White Controller CDMX-1, refer to Universal Tunable White Power Supply Specifications. Up + Down Light fixtures and Systems can be controlled individually or together depending on the power supply selection.

- The Solid State Constant Voltage Uni-Power Supply is compatible with most commercially available Dimmers:
 - Triac Dimmer: (Forward Phase) Typically used for the dimming of Incandescent and Low Voltage Magnetic Transformers
 - ELV Dimmer: (Reverse Phase) Dimming of Electronic Low Voltage Transformers and Power Supplies used for LED lighting
 - 0-10 Dimmer: Dims the Low Voltage side of a 0-10 volt power supply commonly used in large scale lighting or commercial applications.
- The Uni-Power Supply is recommended with any Siemens/Murray brand of arc fault breaker to overcome the issues with tripping the breakers with an ELV LED Low Voltage Drivers.

T-BAR Mounting Kit: Includes power supply, box cover, and T-bar hangers for installing Junction Box above ceiling with in easy reach. Comes with 4' of 14 gauge pair Teflon cables with quick secure connectors.

Ordering Codes : PSB-40W-UNI-24VDC-TB, PSB-60W-UNI-24VDC-TB, PSB-96W-UNI-24VDC-TB, PSB-2X40W-UNI-24VDC-TB, PSB-2X60W-UNI-24VDC-TB, PSB-2X96W-UNI-24VDC-TB, PSB-3X96W-UNI-24VDC-TB, PSB-4X96W-UNI-24VDC-TB

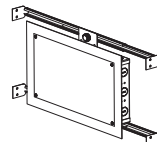
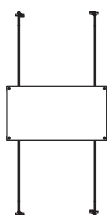

In-Wall Mounting Kit: Includes power supply, box cover and stud hangers for installing Junction Box in wall. Select "IW" in the options section of compatible power supply ordering codes if an In-Wall Mounting Kit is needed.

Ordering Codes 5.1" x 14.25": PSB-40W-UNI-24VDC-IW, PSB-60W-UNI-24VDC-IW, PSB-96W-UNI-24VDC-IW

Ordering Codes 8.5" x 14.25": PSB-2X40W-UNI-24VDC-IW, PSB-2X60W-UNI-24VDC-IW, PSB-2X96W-UNI-24VDC-IW

PROJECT	FIXTURE TYPE	DATE
---------	--------------	------

WIRING DIAGRAMS UNIVERSAL POWER SUPPLY

Application: ELV dimming for Static White and Warm Dim

Dimming: Dimmable with ELV dimmer: Legrand, Adorne ADTP703TU; Lutron: Diva DVELV-300P, Skylark SELV-300P, Maestro MAELV-600 and Radio Ra 2

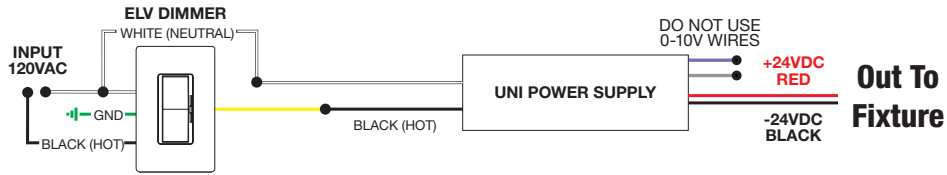

Application: 0-10V dimming for Static White

Dimming: Dimmable with 0-10V dimmer: Philips Sunrise: SR1200ZTUNV; Lutron Diva: DVTV-WH, DVSTV-WH; Lutron Nova T: NTSTV-DV-XX; Lutron Grafix EYE QS: QSGRJ-XP; Lutron Radio Ra2: RRD-10ND; Leviton: LEV40050; Leviton IP710-LFZ; Legrand: ADPD4FBL3P2W4

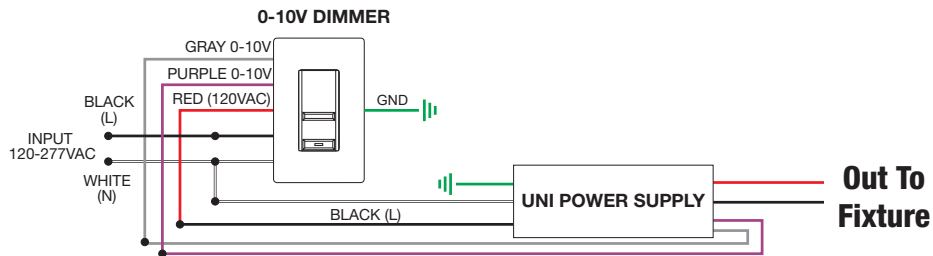





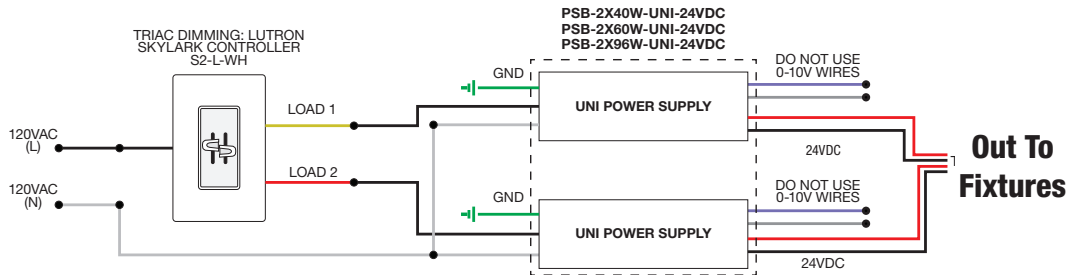

Application: Triac dimming for two power supplies, use for Static White

Dimming: Dimmable with Triac dimmer: Lutron: Skylark S2-L



PROJECT		FIXTURE TYPE		DATE	
---------	--	--------------	--	------	--

ELECTRONIC LOW-VOLTAGE (ELV) POWER SUPPLIES & RECOMMENDED DIMMERS ^{†‡}				
ORDERING CODES	PS-60L-ELV-24VDC 	PSB-60W-ELV-24VDC 	PSB-2X60W-ELV-24VDC 	PSB-100W-ELV-24VDC 
SPECIFICATIONS				
MAXIMUM LOAD	60W NON-IC, 50W-IC (FITS IN JBOX)	60W	2X60W	96W
INPUT VOLTAGE	120VAC	120VAC	120VAC	120VAC
OUTPUT VOLTAGE	24VDC	24VDC	24VDC	24VDC
DIMENSIONS	2.25" X 1.25" X 0.83"	8.125" X 2" X 1.75"	12.15" X 6.48" X 2.18"	9.25" X 3.5" X 2"
CLASSIFICATION	CLASS 2	CLASS 2	CLASS 2	CLASS 2
T-BAR MOUNTING	N/A	PSB-60W-ELV-24VDC-TB	PSB-2X60W-ELV-24VDC-TB	PSB-100W-ELV-24VDC-TB
IN WALL MOUNTING	N/A	PSB-60W-ELV-24VDC-IW	PSB-2X60W-ELV-24VDC-IW	PSB-100W-ELV-24VDC-IW
ELECTRONIC LOW-VOLTAGE (ELV) POWER SUPPLIES & RECOMMENDED DIMMERS ^{†‡}				
ORDERING CODES	PSB-2X100W-ELV-24VDC 	PSB-3X100W-ELV-24VDC 	PSB-4X100W-ELV-24VDC 	
SPECIFICATIONS				
MAXIMUM LOAD	2X96W	3X96W	4X96W	
INPUT VOLTAGE	120VAC	120VAC	120VAC	
OUTPUT VOLTAGE	24VDC	24VDC	24VDC	
DIMENSIONS	12.15" X 6.48" X 2.18"	14" X 10" X 3"	17" X 13" X 3"	
CLASSIFICATION	CLASS 2	CLASS 2	CLASS 2	
T-BAR MOUNTING	PSB-2X100W-ELV-24VDC-TB	PSB-3X100W-ELV-24VDC-TB	PSB-4X100W-ELV-24VDC-TB	
IN WALL MOUNTING	PSB-2X100W-ELV-24VDC-IW	N/A	N/A	
DIMMING AND CONTROLS				
LUTRON DIVA: DVELV-300P	•	•	•	
LUTRON SKYLARK: SELV-300P	•	•	•	
LUTRON RADIO RA2: RRD-6NA	•	•	•	
LUTRON MAESTRO: MAELV-600	•	•	•	
LEGRAND ADORNE: ADTP-703TUM4	•	•	•	

[†]22K - 57K color temperatures are compatible with 0-10V, ELV, and Lutron Hi-Lume® Power Supplies. Warm Dim (27D, 30D) color temperatures are only compatible with ELV power supplies. Tunable White color temperature is compatible with 0-10V, ELV, DMX, and Lutron Hi-Lume® Power Supplies. Color (RGB, RGB+W) and Static Color (Amber, Blue, Green, or Red) are compatible with DMX Power Supplies.

[‡]Electrical Panels using Siemens/Murray AFCI breakers are not compatible with this ELV transformer. Use 0-10 Volt power supplies with this breaker

With N-Lite Dimming Do Not use ELV power supplies, use only 0-10 volt or Uni drivers power supplies

**Up + Down Light fixtures and Systems can be controlled individually or together depending on the power supply selection.

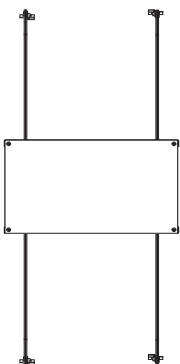

T-Bar Mounting Kit: Includes power supply, box cover, and T-bar hangers for installing Junction Box above ceiling with in easy reach. Comes with 4' of 14 gauge pair Teflon cables with quick secure connectors.

Ordering Codes : PSB-60W-ELV-24VDC-TB
PSB-100W-ELV-24VDC-TB
PSB-2X60W-ELV-24VDC-TB
PSB-2X100W-ELV-24VDC-TB
PSB-3X100W-ELV-24VDC-TB
PSB-4X100W-ELV-24VDC-TB

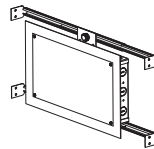

In-Wall Mounting Kit: Includes power supply, box cover and stud hangers for installing Junction Box in wall. Select "IW" in the options section of compatible power supply ordering codes if an In-Wall Mounting Kit is needed.

Ordering Codes 5.1" x 14.25": PSB-60W-ELV-24VDC-IW
PSB-100W-ELV-24VDC-IW

Ordering Codes 8.5" x 14.25": PSB-2X60W-ELV-24VDC-IW
PSB-2X100W-ELV-24VDC-IW

PROJECT		FIXTURE TYPE		DATE	
---------	--	--------------	--	------	--

SAMPLE WIRING DIAGRAMS 24VDC ELV

Application: ELV dimming for Static White

Dimming: Dimmable with ELV dimmer: Legrand, Adorne ADTP703TU; Lutron: Diva DVELV-300P, Skylark SELV-300P, Maestro MAELV-600 and Radio Ra 2

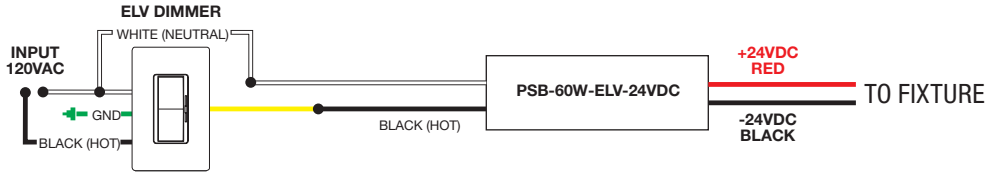

Application: ELV dimming for Static White

Dimming: Dimmable with ELV dimmer: Legrand, Adorne ADTP703TU; Lutron: Diva DVELV-300P, Skylark SELV-300P, Maestro MAELV-600 and Radio Ra 2

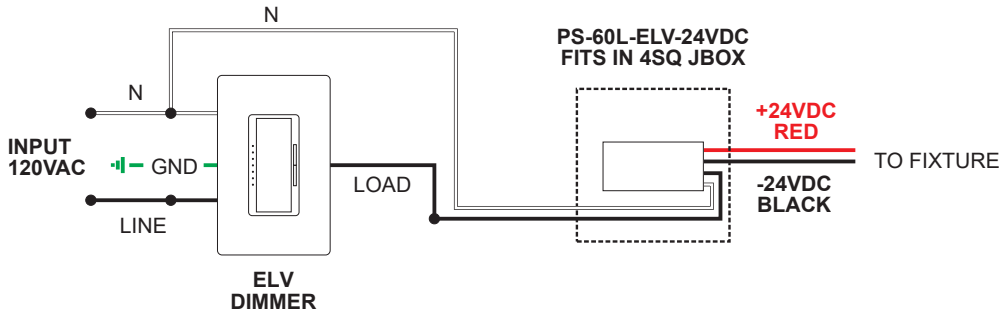

Application: Dual ELV dimming for Static White

Dimming: Dimmable with ELV dimmer: Legrand, Adorne ADTP703TU; Lutron: Diva DVELV-300P, Skylark SELV-300P, Maestro MAELV-600 and Radio Ra 2

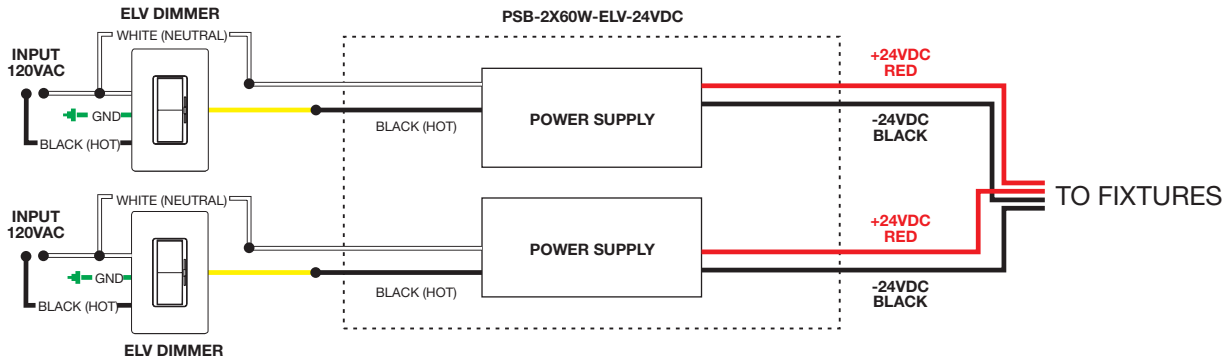

PROJECT		FIXTURE TYPE		DATE	
---------	--	--------------	--	------	--

0-10 VOLT (010) POWER SUPPLIES & RECOMMENDED DIMMERS

ORDERING CODE	PSB-25W-010-24VDC	PSB-60W-010-24VDC	PSB-96W-010-24VDC
SPECIFICATIONS			
MAXIMUM LOAD	25W	60W	96W
INPUT VOLTAGE	120-277VAC	120-277VAC	120-277VAC
OUTPUT VOLTAGE	24VDC	24VDC	24VDC
DIMENSIONS	12.4" X 3.12" X 2.18"	12.4" X 3.12" X 2.18"	12.4" X 3.12" X 2.18"
CLASSIFICATION	CLASS 2	CLASS 2	CLASS 2
T-BAR MOUNTING	PSB-25W-010-24VDC-TB	PSB-60W-010-24VDC-TB	PSB-96W-010-24VDC-TB
IN-WALL MOUNTING	PSB-25W-010-24VDC-IW	PSB-60W-010-24VDC-IW	PSB-96W-010-24VDC-IW

0-10 VOLT (010) POWER SUPPLIES & RECOMMENDED DIMMERS

ORDERING CODE	PSB-2X96W-010-24VDC	PSB-3X96W-010-24VDC	PSB-4X96W-010-24VDC
SPECIFICATION			
MAXIMUM LOAD	2X96W	3X96W	4X96W
INPUT VOLTAGE	120-277VAC	120-277VAC	120-277VAC
OUTPUT VOLTAGE	24VDC	24VDC	24VDC
DIMENSIONS	12.15" X 6.48" X 2.18"	14" X 10" X 3"	17" X 13" X 3"
CLASSIFICATION	CLASS 2	CLASS 2	CLASS 2
T-BAR MOUNTING	PSB-2X96W-010-24VDC-TB	PSB-3X96W-010-24VDC-TB	PSB-4X96W-010-24VDC-TB
IN-WALL MOUNTING	PSB-2X96W-010-24VDC-IW	N/A	N/A

DIMMING & CONTROLS

PHILIPS SUNRISE: SR1200ZTUNV	•	•	•
LUTRON DIVA: DVTV-WH, DVSTV-WH	•	•	•
LUTRON NOVA T: NTSTV-DV-XX	•	•	•
LUTRON GRAFIX EYE QS: QSGRJ-XP	•	•	•
LUTRON RADIO RA2: RRD-10ND	•	•	•
LEVITON: LEV40050	•	•	•
LEVITON IP710-LFZ	•	•	•
LEGRAND: ADPD4FBL3P2W4	•	•	•

- Flicker free dimming
- Aluminum casing for optimal heat dissipation
- Isolated output power per NEC and UL safety requirements
- UL & ETL recognized/ listed, meets UL 8750, 1310 requirements

- Auto-reset; short circuit, overload and thermal protection
- Class 2 power supply
- Efficient, High power factor > 90

*Title 24 compliant when used with JAB listed PureEdge systems.

**Up + Down Light fixtures and Systems can be controlled individually or together depending on the power supply selection.

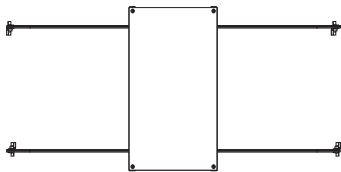

T-BAR Mounting Kit: Includes power supply, box cover, and T-bar hangers for installing Junction Box above ceiling with in easy reach. Comes with 4' of 14 gauge pair Teflon cables with quick secure connectors.

Ordering Codes:
 PSB-25W-010-24VDC-TB,
 PSB-60W-010-24VDC-TB,
 PSB-96W-010-24VDC-TB,
 PSB-2X96W-010-24VDC-TB
 PSB-3X96W-010-24VDC-TB
 PSB-4X96W-010-24VDC-TB

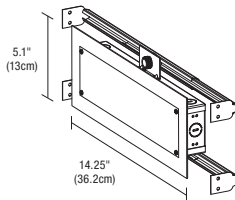

5.1" x 14.25" In-Wall Mounting Kit: Includes power supply, box cover and stud hangers for installing Junction Box in wall. Select "IW" in the options section of compatible power supply ordering codes if an In-Wall Mounting Kit is needed.

Ordering Codes: PSB-25W-010-24VDC-IW, PSB-60W-010-24VDC-IW, PSB-96W-010-24VDC-IW

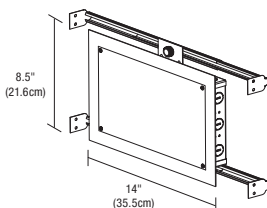

8.5" x 14" In-Wall Mounting Kit: Includes power supply, box cover and stud hangers for installing Junction Box in wall. Select "IW" in the options section of compatible power supply ordering codes if an In-Wall Mounting Kit is needed.

Ordering Codes: PSB-2X96W-010-24VDC-IW

PROJECT	FIXTURE TYPE	DATE
---------	--------------	------

SAMPLE WIRING DIAGRAMS 24VDC 010

Application: 0-10V Dimming Applications For Static White and Warm Dim

Dimming: Dimmable with 0-10V dimmers: Signify (Phillips) Sunrise: SR1200ZTUNV, Leviton Dimmers: LEV40050, IP710-LFZ, *IP710-DLZ *(Built in LED locator light) Legrand Dimmer: ADPD4FBL3P2W4 Lutron Systems: Lutron GRAFIX Eye QS Main Unit (with DRX-TVI) Radio Ra2 (with GRX-TVI)

0-10V DIMMER

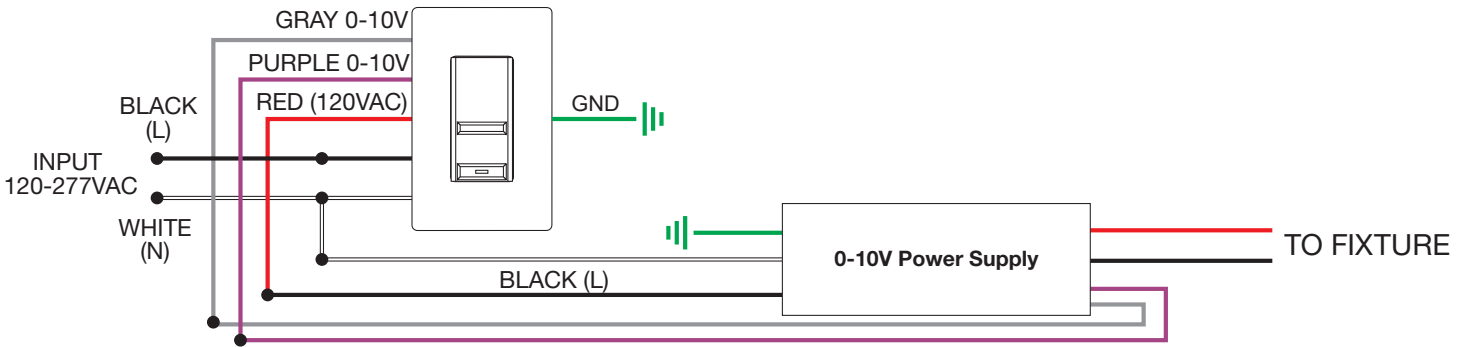

Application: Dual 0-10V dimming for Static White

Dimming: Dimmable with Dual 0-10V dimmers: Signify (Phillips) Sunrise: SR1200ZTUNV, Leviton Dimmers: LEV40050, IP710-LFZ, *IP710-DLZ *(Built in LED locator light), Legrand Dimmer: ADPD4FBL3P2W4, Lutron Systems: Lutron GRAFIX Eye QS Main Unit (with DRX-TVI) Radio Ra2 (with GRX-TVI)

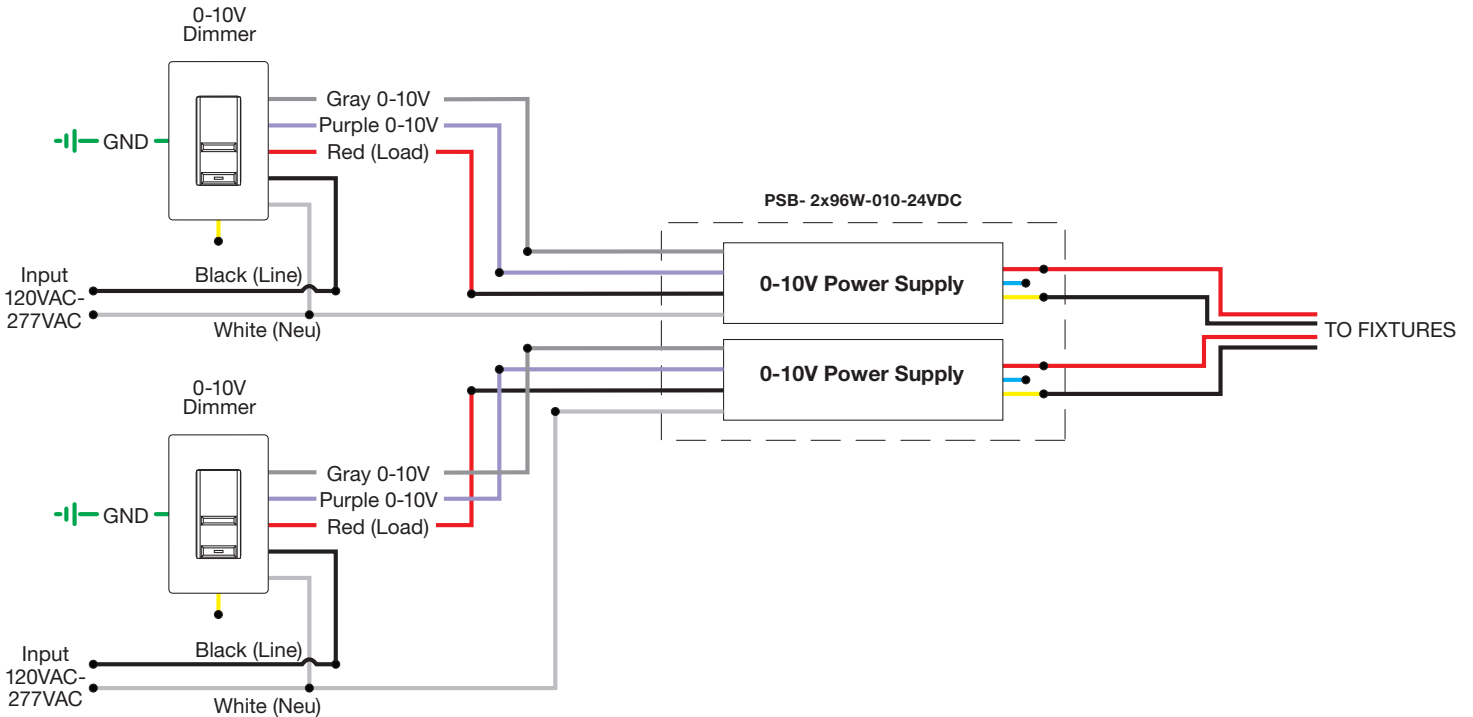

PROJECT		FIXTURE TYPE		DATE	
---------	--	--------------	--	------	--

INDOOR TUNABLE WHITE 0-10V 96 WATT LED POWER SUPPLY

24VDC INDOOR CONSTANT VOLTAGE, TWO CHANNEL CONTROLS, FOR INTENSITY AND COLOR TEMPERATURE

DESIGNED BY GREGORY KAY | ASSEMBLED IN AMERICA

REV 08.11.21



PSB-96W-010-24VDC-2XK

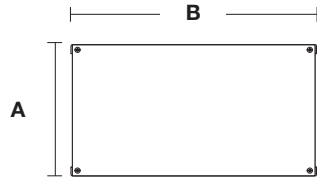

TOP VIEW

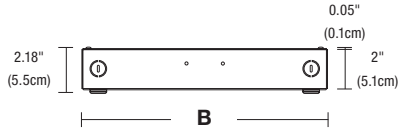

SIDE VIEW

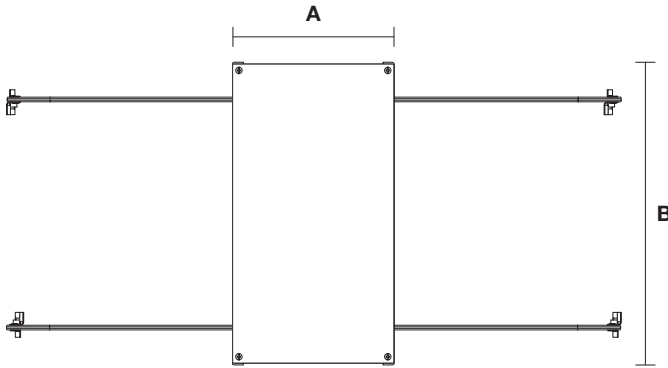

PSB-96W-010-24VDC-2XK-TB
(T-BAR GRID CEILING)

STANDARD & T-BAR DIMENSIONS		
	A	B
PSB-96W-010-24VDC-2XK	6.48"	12.15"
PSB-2X96W-010-24VDC-2XK	10"	14"
PSB-3X96W-010-24VDC-2XK	13"	17"
PSB-4X96W-010-24VDC-2XK	13"	17"

DESCRIPTION

Accepts input voltage in a range of 120 - 277VAC and outputs 24VDC power up to 96 watts. The low voltage output dims down to 1% when two additional wires are connected to a 0-10V dimmer. The enclosure provides a space inside for electrical connections. In-Wall Power Supply Kit includes power supply, box cover and stud hangers. T-Bar Mounting Kit includes power supply, box cover, and T-bar hangers for installing Junction Box above ceiling with in easy reach. Comes with 4' of 14 gauge pair Teflon cables with quick secure connectors. Power Supply features short circuit, overload and over temperature protection.

APPLICATIONS

Indoor, Damp Location

MOUNTING

Surface mounted with conduit access

POWER INPUT

120-277VAC

POWER OUTPUT

Class 2; 24 volts DC 4A, up to 96 watts maximum

EFFICIENCY

90%

AMBIENT OPERATING TEMPERATURE

-25° C to 40° C

DIMMING

#1 Controls the intensity. #2 Controls the Color Temperature.
0-10V (dimmer needs to be capable to dim to 0% without ON/OFF switch)

DIMMING CURVE

Linear, Logarithmic 100% - 0% (HydraDrive)

COMPLIANCE

Made in the USA, UL, CE, Title 28, Plenum for use in Accordance with UL 2043.
*Title 24 with JA8 listed PureEdge products and systems

Product	Wattage	Dimming	Voltage	Color Temperature	Options
PSB	96W	010	24VDC	2XK	STANDARD (Leave Blank)
PSB Power Supply with Enclosure Box with Tunable White 0-10V Controller	96W 96 Watts 2X96W 2x96 Watts 3X96W 3x96 Watts 4X96W 4x96 Watts	010 0-10 Volt Dimming	24VDC 24 Volt DC	2XK Tunable White	TB T-Bar Grid Ceiling IW* In-Wall Kit *96 watts only



PSB-96W-010-24VDC-2XK-IW

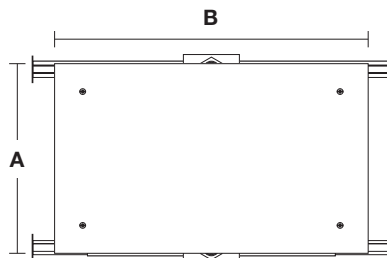

PSB-96W-010-24VDC-2XK-IW (IN WALL KIT)

IN-WALL DIMENSIONS		
	A	B
PSB-96W-010-24VDC-2XK-IW	8.5"	14.25"

PROJECT		FIXTURE TYPE		DATE	
---------	--	--------------	--	------	--

Application: 0-10V dimming for Tunable White LED Strip/Fixture

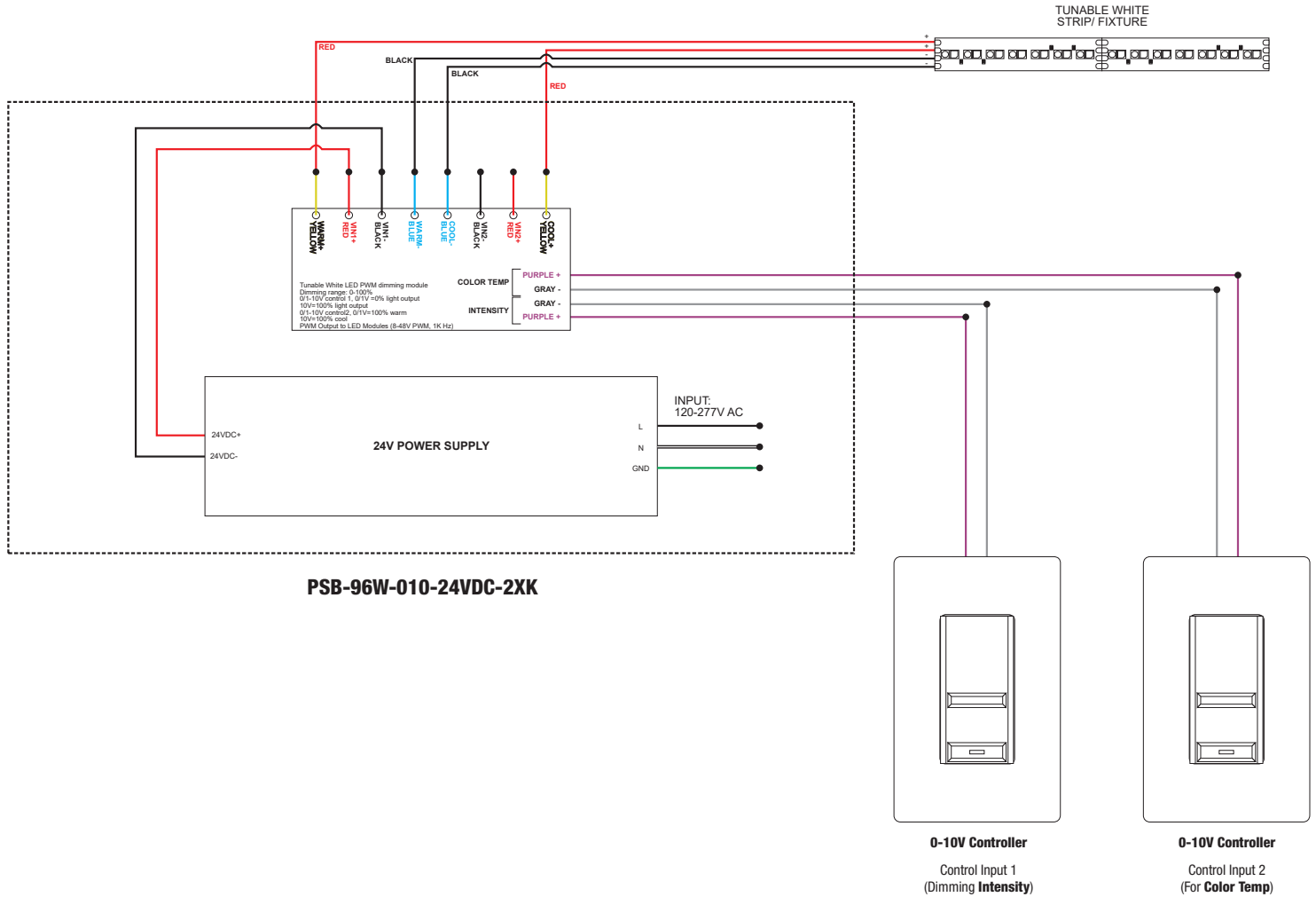

T-BAR GRID CEILING

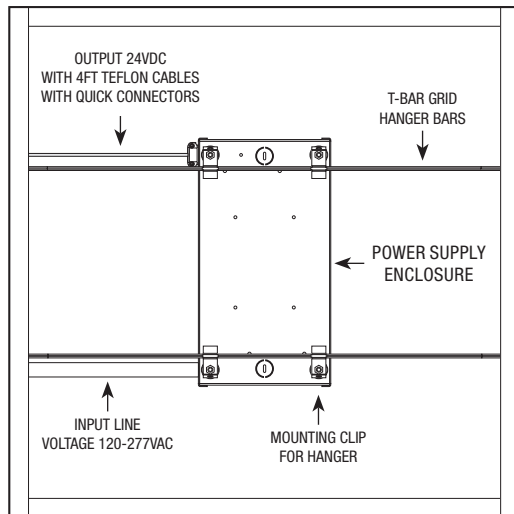

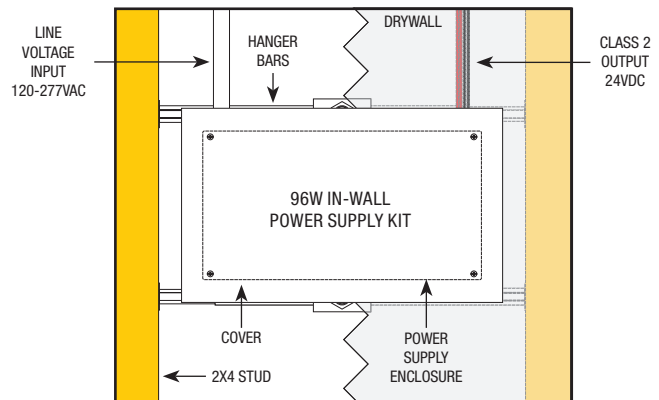

IN WALL KIT



PROJECT		FIXTURE TYPE		DATE	
---------	--	--------------	--	------	--

LUTRON HI-LUME® PREMIER .1% ECOSYSTEM®†

ORDERING CODES	L3D0-96W24V-U	2-WIRE ECOSYSTEM LTEA4U1UKL-CV240	3-WIRE ECOSYSTEM L3DA4U1UKL-CV240
			
SPECIFICATIONS			
MAXIMUM LOAD	96W	5W-40W	5W-40W
INPUT VOLTAGE	120-277VAC	120-277VAC	120-277VAC
OUTPUT VOLTAGE	24VDC	24VDC	24VDC
DIMENSIONS	10.5" X 5.5" X 2"	4" X 4.89" X 2.62"	4" X 4.89" X 2.62"
CLASSIFICATION	CLASS 2	CLASS 2	CLASS 2
T-BAR MOUNTING	L3D0-96W24V-U-TB	NA	NA
DIMMING AND CONTROLS			
RADIO RA2	•	•	•
HOMEWORKS QS	•	•	•
PHPM-3F-120	•	•	•
PHPM-3F-DV	•	•	•
BCI-0-10	•	•	•

†22K - 57K color temperatures are compatible with 0-10V, ELV, and Lutron Hi-lume® Power Supplies.

*Title 24 compliant when used with JA8 listed PureEdge systems.

**WIRING DIAGRAM FOR
LTEA4U1UKL-CV240 OR L3D0-96W24V-U
ECOSYSTEM DIGITAL LINK**

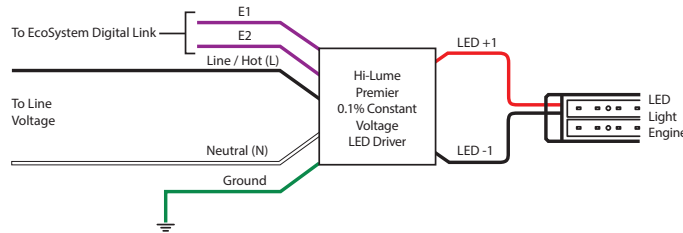

**COMPATIBLE DIMMERS FOR
LTEA4U1UKL-CV240 OR L3D0-96W24V-U
ECOSYSTEM DIGITAL LINK**

Product	Model Number		Drivers Per Control	Recommended System Version ²
	120V	277V		
PowPak Dimming Module with EcoSystem	RMJ-ECO32-DV-B URMJ-ECO32-DVB		32 Per EcoSystem link	5.9 or Higher
PowPak Wireless Fixture Control with EcoSystem¹	FJC-ECO FJCS-ECO		3 Per EcoSystem link	0796554 or Higher
Energi Savr Node unit with EcoSystem	QSN-1ECO-S, QSN-2ECO-S, QSN-2ECO-PS120, UQSN-1ECO-S, UQSN-2ECO-S,		64 Per EcoSystem link	9.027 or Higher
GRAFIK Eye QS unit with EcoSystem	QSGRJ-_E- QSGR-_E-	-	64 Per EcoSystem link	9.009 or Higher
Quantum Light Management Hub	AYF-103P-	-	64 Per EcoSystem link	3.2 or Higher ³
Homeworks QS with EcoSystem	LQSE-2ECO-D- QSGRJ-_E- QSGR-_E-	-	64 Per EcoSystem link	10 or Higher ⁴

1: All devices connected to one PowPak Wireless Fixture Control will be controlled together. Devices will dim to the same level as the result of a control command. The wireless fixture control will need to have it's low end level reprogrammed to dim to 0.1% output. For more details on adjusting low end light level refer to Application Note #556 at www.Lutron.com

2: For lower system versions please visit www.Lutron.com/LEDsystemcheck to check if your system requires changes

3: Version 3.1 (or later) is required to dim lower than 1%

4: Version 7.0 (or later) is required to dim lower than 1%

PROJECT		FIXTURE TYPE		DATE	
---------	--	--------------	--	------	--

TUNABLE WHITE DMX CONTROLLER AND POWER SUPPLIES

24VDC INDOOR CONSTANT VOLTAGE POWER SUPPLIES WITH DRIVERS

REV 08.11.21

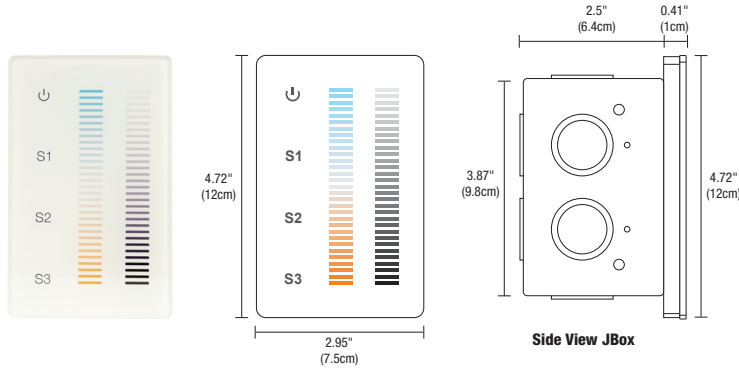

DESCRIPTION:

The Tunable White Touch Controller offers fast and accurate Color Temperature adjustment and the ability to regulate the Brightness Independently. The modern Glass faceplate features illuminated indicators, and a back-lit night light that softly illuminates the controller when powered off. Designed for Tunable White, and dual-color LED installations within a single zone. The two Vertical Touch sliders are precise and sensitive, allowing you to fine-tune your perfect Color Temperature at any point between **2000K** (Sunset) to **6500K** (Daylight White) while selecting over 250 levels of Brightness in a smooth, uninterrupted transition. Create Thousands of White Color Combinations while maintaining even Brightness and overall saturation. Easily save three pre-set scenes for different times of the day. Support health, performance, and general well-being using Human-Centric lighting by fine-tuning the biological effects that light has on the circadian cycle using the latest in LED technology. Includes a power adapter that fits behind the controller within a standard junction box and fits inside a standard single-gang receptacle (not for use in a multi-gang box). Use with an insulated, 24 AWG stranded, tinned copper wire (Belden #9841). Power Supplies are Sold Separately. Includes a 5 year pro-rated warranty.

APPLICATIONS:

Indoor

OUTPUT SIGNAL:

USITT DMX 512 (1990)

INSTALLATION:

Fits in a single gang 2.5" deep junction box. Not compatible with multi-gang boxes.

LABELS:

ROHS, FCC, Damp Location, ETL/UL

POWER INPUT:

120-240VAC

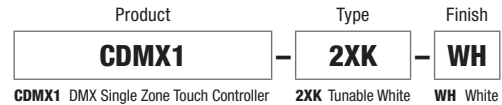
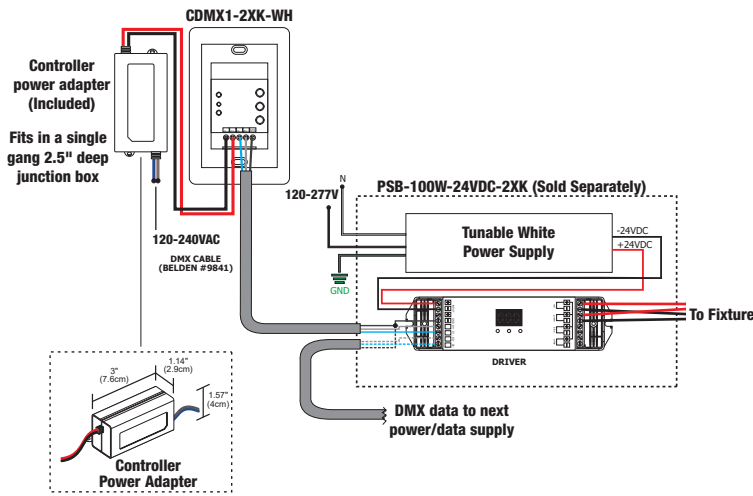

COLOR CHANGING (DMX) POWER SUPPLIES

ORDERING CODE	PSB-100W-24VDC-2XK	PSB-2X100W-24VDC-2XK	PSB-3X100W-24VDC-2XK	PSB-4X100W-24VDC-2XK
SPECIFICATIONS				
MAXIMUM LOAD OF LED STRIP LENGTH	100W 5 WATTS - 20FT MAX. 10 WATTS - 10FT MAX.	2X100W 5 WATTS 2 X 20FT MAX. 10 WATTS - 2 X 10FT MAX.	3X100W 5 WATTS 3 X 20FT MAX. 10 WATTS - 3 X 10FT MAX.	4X100W 5 WATTS 4 X 20FT MAX. 10 WATTS - 4 X 10FT MAX.
INPUT VOLTAGE	120-277VAC	120-277VAC	120-277VAC	120-277VAC
OUTPUT VOLTAGE	24VDC	24VDC	24VDC	24VDC
DIMENSIONS	12.4" X 6.48" X 2.18"	14" X 10" X 3"	17" X 10" X 3"	17" X 10" X 3"
CLASSIFICATION	CLASS 2	CLASS 2	CLASS 2	CLASS 2
T-BAR MOUNTING	PSB-100W-24VDC-2XK-TB	PSB-2X100W-24VDC-2XK-TB	PSB-3X100W-24VDC-2XK-TB	PSB-4X100W-24VDC-2XK-TB
IN-WALL MOUNTING	PSB-100W-24VDC-2XK-IW	NA	NA	NA
DMX TUNABLE WHITE DIMMING & CONTROLS				
TUNABLE WHITE TOUCH CONTROLLER (CDMX1-2XK)	•	•	•	•

- Flicker free dimming
- Aluminum casing for optimal heat dissipation
- Isolated output power per NEC and UL safety requirements
- UL & ETL recognized/ listed, meets UL 8750, 1310 requirements

- Auto-reset; short circuit, overload and thermal protection
- Class 2 power supply
- Efficient, High power factor > 0.90

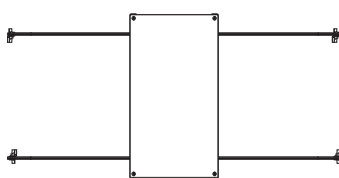

T-BAR Mounting Kit: Includes power supply, box cover, and T-bar hangers for installing Junction Box above ceiling with in easy reach. Comes with 4ft of 14 gauge pair Teflon cables with quick secure connectors.

Ordering Codes:
 PSB-100W-24VDC-2XK-TB
 PSB-2x100W-24VDC-2XK-TB
 PSB-3x100W-24VDC-2XK-TB
 PSB-4x100W-24VDC-2XK-TB

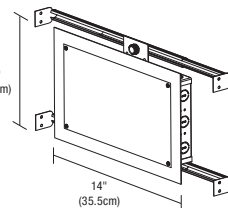

8.5" x 14" In-Wall Mounting Kit: Includes power supply, box cover and stud hangers for installing Junction Box in wall. Select "IW" in the options section of compatible power supply ordering codes if an In-Wall Mounting Kit is needed.

Ordering Codes:
 PSB-100W-24VDC-2XK-IW

PROJECT	FIXTURE TYPE	DATE
---------	--------------	------

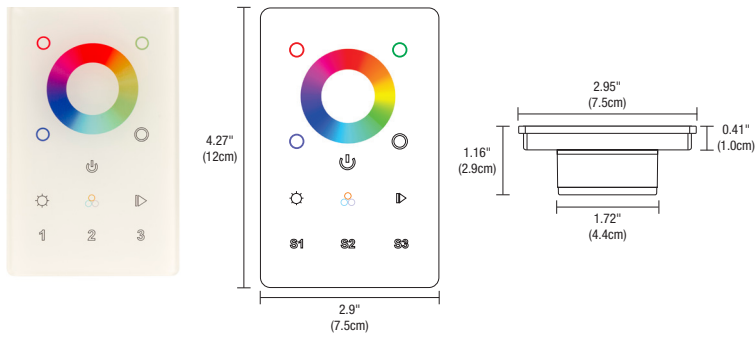

DESCRIPTION

Full touch controller offers fast and accurate color tone adjustment and independent brightness control. The 1 zone controller can adjust RGB and RGBW LEDs smoothly and accurately. Independent smooth dimming of each channel enables the controller to achieve millions of colors. For indoor applications only, and includes a Power Adapter to operate the controller.

APPLICATIONS

Indoor

POWER INPUT

120-277VAC

INSTALLATION

Fits in a single gang 2.5" deep junction box, not to be used with a multi gang box

OUTPUT SIGNAL

USITT DMX 512 (1990)

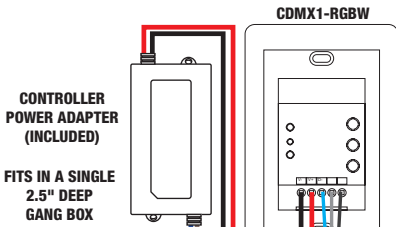

Product	Type	Finish
CDMX1	RGBW	WH
CDMX1 DMX 1 Zone Touch Controller	RGBW RGB & RGBW	WH White

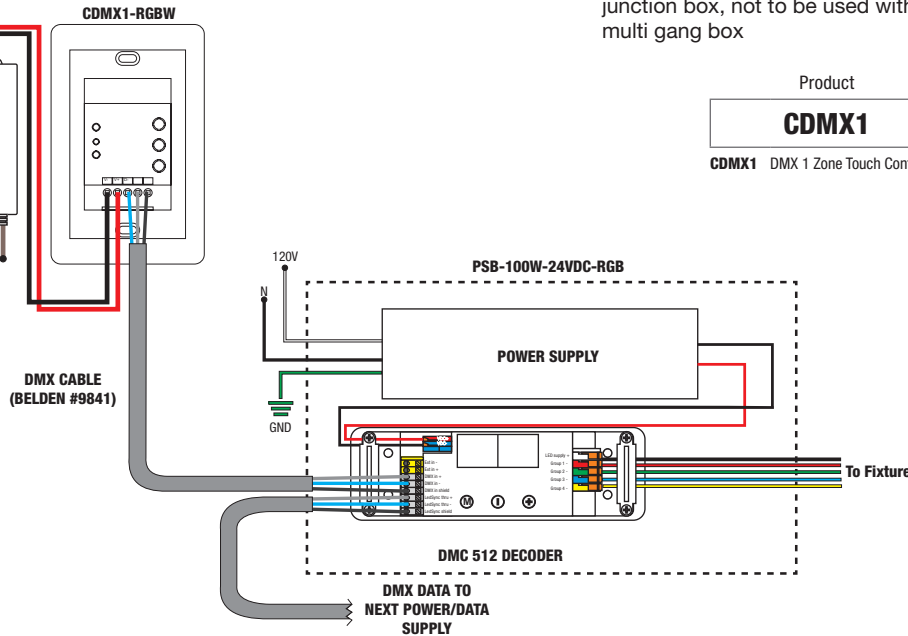

DYNAMIC COLOR CHANGING (DMX) POWER SUPPLIES & RECOMMENDED CONTROLLERS

ORDERING CODE	PSB-100W-24VDC-RGB	PSB-2X100W-24VDC-RGB	PSB-3X100W-24VDC-RGB	PSB-4X100W-24VDC-RGB
SPECIFICATIONS				
MAXIMUM LOAD	100W	2X100W	3X100W	4X100W
INPUT VOLTAGE	120-277VAC	120-277VAC	120-277VAC	120-277VAC
OUTPUT VOLTAGE	24VDC	24VDC	24VDC	24VDC
DIMENSIONS	12.14" X 6.48" X 2.18"	14" X 10" X 3"	17" X 13" X 3"	17" X 13" X 3"
CLASSIFICATION	CLASS 2	CLASS 2	CLASS 2	CLASS 2
IN-WALL MOUNTING	PSB-100W-24VDC-RGB-IW	N/A	N/A	N/A
DIMMING & CONTROLS				
TOUCH SCREEN CONTROLLER (CTP)	•	•	•	•
COLOR DIAL CONTROLLER (CDP)	•	•	•	•
DMX 1 ZONE RGBW TOUCH CONTROLLER (CDMX1-RGBW)	•	•	•	•

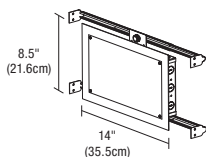

8.5" X 14" IN-WALL MOUNTING KIT

Includes Power Supply, Box Cover, and Stud Hangers for installing Junction Box in wall. Select "IW" in the options section of compatible Power Supply ordering codes if an In-Wall Mounting Kit is needed.

ORDERING CODES: PSB-100W-24VDC-RGB-IW

PROJECT	FIXTURE TYPE	DATE
---------	--------------	------

LIGHT CHANNEL TM30 DATA

24VDC SURFACE MOUNT LIGHT CHANNEL, STATIC WHITE & COLOR, TUNABLE WHITE, WARM DIM & RGB

TM-30-15 DATA: The data below is for SS2C, SS5C, and SS7C bare LED Soft Strips. Consistent color temperatures throughout a single strip and among multiple strips is possible through a 3 phase binning process in which each order is inspected with a color meter to ensure uniformity.

2200K | Rf: 83.9 | Rg: 94.9

Color Vector Graphic

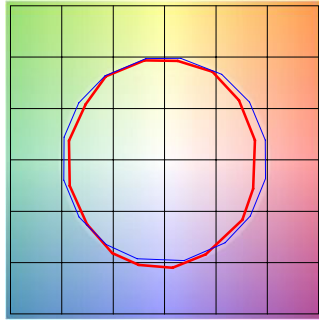

■ Test ■ Reference

		GRAPHIC SHIFTS %	
HUE BIN	Rf	CHROMA	HUE
1	77.6	-10.0%	1.8%
2	80.7	-7.5%	7.0%
3	79.5	-2.9%	8.9%
4	90.5	-3.1%	2.4%
5	93.9	-1.3%	1.9%
6	91.9	-0.9%	-0.2%
7	87.6	-6.3%	-2.7%
8	90.5	-5.4%	2.7%
9	83.8	-4.7%	6.5%
10	81.2	-2.5%	10.0%
11	83.3	3.9%	9.4%
12	86.4	5.6%	2.6%
13	86.2	4.5%	-12.4%
14	64.3	-1.0%	-21.9%
15	85.1	-4.4%	-7.5%
16	75.0	-9.9%	-12.0%

2400K | Rf: 91.2 | Rg: 96.8

Color Vector Graphic

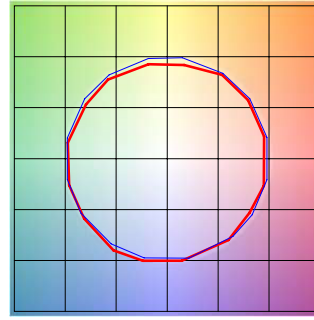

■ Test ■ Reference

		GRAPHIC SHIFTS %	
HUE BIN	Rf	CHROMA	HUE
1	92.0	-2.4%	1.5%
2	94.7	-2.1%	0.0%
3	95.4	-1.9%	-0.1%
4	88.7	-6.7%	-3.1%
5	92.8	-5.6%	1.0%
6	92.7	-3.4%	3.4%
7	89.9	-4.3%	4.1%
8	92.4	-1.4%	4.4%
9	89.0	-0.6%	5.8%
10	86.9	0.4%	6.2%
11	89.7	4.0%	5.4%
12	92.6	3.0%	-0.7%
13	90.9	1.1%	-7.0%
14	89.9	0.5%	-5.8%
15	92.1	-3.2%	0.1%
16	88.9	-1.7%	-6.3%

2700K | Rf: 87.7 | Rg: 96.1

Color Vector Graphic

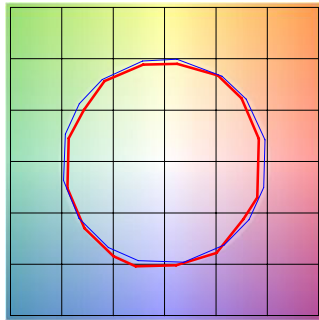

■ Test ■ Reference

		GRAPHIC SHIFTS %	
HUE BIN	Rf	CHROMA	HUE
1	86.4	-5.6%	2.3%
2	89.7	-3.3%	3.1%
3	90.5	-1.5%	3.8%
4	90.0	-4.3%	1.1%
5	92.9	-3.7%	0.2%
6	93.5	-2.5%	-0.8%
7	86.3	-7.2%	2.5%
8	90.7	-4.0%	3.2%
9	85.2	-2.4%	8.1%
10	81.7	0.9%	10.8%
11	85.4	4.5%	8.9%
12	88.7	5.7%	-1.4%
13	88.3	1.3%	-7.9%
14	85.1	2.4%	-10.4%
15	88.1	-4.8%	-2.7%
16	81.7	-4.3%	-10.9%

3000K | Rf: 88.1 | Rg: 99.7

Color Vector Graphic

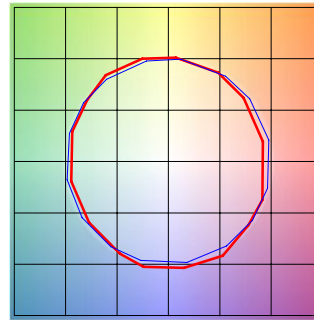

■ Test ■ Reference

		GRAPHIC SHIFTS %	
HUE BIN	Rf	CHROMA	HUE
1	87.7	-5.9%	-0.3%
2	87.9	-4.4%	4.3%
3	82.9	-1.2%	7.9%
4	89.9	0.6%	4.7%
5	92.7	3.0%	3.5%
6	92.7	3.6%	-1.7%
7	90.8	-1.3%	-4.4%
8	93.7	-2.5%	-2.2%
9	91.7	-3.7%	2.3%
10	85.5	-2.8%	7.8%
11	83.3	0.7%	11.0%
12	86.4	5.5%	3.8%
13	90.6	4.6%	-3.6%
14	85.6	5.9%	-8.4%
15	89.5	-0.6%	-5.7%
16	82.6	-2.7%	-12.0%

3500K | Rf: 86.1 | Rg: 95.5

Color Vector Graphic

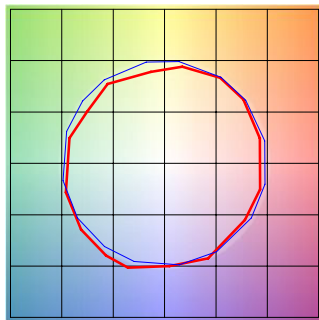

■ Test ■ Reference

		GRAPHIC SHIFTS %	
HUE BIN	Rf	CHROMA	HUE
1	86.6	-4.2%	3.4%
2	91.7	-1.4%	1.8%
3	94.9	-0.7%	0.4%
4	87.9	-4.5%	-4.1%
5	85.9	-10.3%	-2.7%
6	89.8	-5.2%	-0.4%
7	79.6	-9.5%	6.5%
8	87.6	-4.0%	5.7%
9	81.4	-0.5%	11.8%
10	78.3	3.3%	11.4%
11	85.7	6.3%	6.1%
12	86.3	7.1%	-4.6%
13	86.1	-0.7%	-9.6%
14	85.1	0.8%	-10.4%
15	83.4	-4.1%	-5.3%
16	82.5	-3.6%	-5.7%

4000K | Rf: 87.6 | Rg: 96.8

Color Vector Graphic

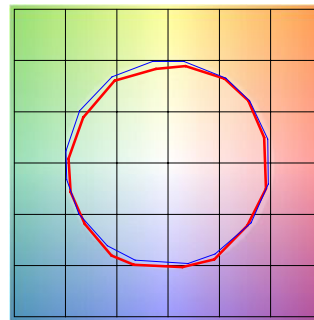

■ Test ■ Reference

		GRAPHIC SHIFTS %	
HUE BIN	Rf	CHROMA	HUE
1	89.0	-3.1%	2.1%
2	93.2	-0.9%	1.3%
3	94.3	-1.1%	0.7%
4	89.5	-4.0%	-2.3%
5	87.6	-7.8%	-1.8%
6	92.2	-4.6%	0.1%
7	87.4	-6.6%	3.6%
8	85.7	-3.8%	7.0%
9	81.5	-1.3%	12.4%
10	80.0	0.9%	11.4%
11	83.3	5.9%	8.7%
12	89.7	4.8%	-0.3%
13	88.5	2.4%	-6.3%
14	92.7	4.0%	-3.8%
15	86.1	-1.6%	-4.5%
16	85.0	-1.4%	-5.0%

PROJECT	FIXTURE TYPE	DATE
---------	--------------	------

LIGHT CHANNEL TM30 DATA

24VDC SURFACE MOUNT LIGHT CHANNEL, STATIC WHITE & COLOR, TUNABLE WHITE, WARM DIM & RGB

TM-30-15 DATA: The data below is for SS2C, SS5C, and SS7C bare LED Soft Strips. Consistent color temperatures throughout a single strip and among multiple strips is possible through a 3 phase binning process in which each order is inspected with a color meter to ensure uniformity.

5700K | Rf: 80.3 | Rg: 91.5

Color Vector Graphic

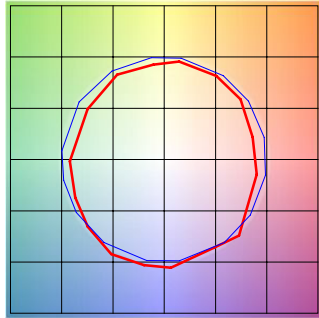

■ Test ■ Reference

GRAPHIC SHIFTS %			
HUE BIN	Rf	CHROMA	HUE
1	73.8	-11.2%	2.6%
2	83.7	-5.5%	5.8%
3	84.2	-4.0%	5.5%
4	85.8	-3.5%	1.3%
5	85.3	-7.1%	0.6%
6	89.2	-5.8%	-2.2%
7	81.5	-10.7%	1.2%
8	75.7	-9.7%	8.5%
9	74.9	-7.8%	18.8%
10	67.8	-1.6%	18.0%
11	76.1	5.5%	12.0%
12	90.8	4.9%	-1.6%
13	83.6	5.0%	-9.5%
14	81.7	-1.2%	-10.0%
15	69.0	2.0%	-22.8%
16	83.2	-8.5%	-1.0%

2700D | Rf: 89.5 | Rg: 100.8

Color Vector Graphic

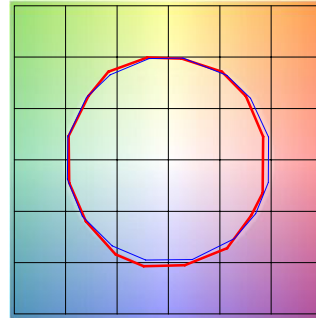

■ Test ■ Reference

GRAPHIC SHIFTS %			
HUE BIN	Rf	CHROMA	HUE
1	88.8	-5.1%	1.4%
2	89.8	-2.7%	4.1%
3	87.2	0.3%	5.9%
4	92.3	-0.9%	1.0%
5	93.3	1.5%	1.7%
6	92.4	3.6%	-0.2%
7	92.2	-0.9%	-2.4%
8	96.7	-0.4%	-1.1%
9	92.3	-1.2%	3.7%
10	88.9	-0.0%	6.1%
11	86.4	5.1%	7.4%
12	88.2	6.3%	-0.9%
13	87.2	3.8%	-8.1%
14	84.2	3.8%	-11.0%
15	89.8	-2.6%	-4.3%
16	82.7	-3.4%	-11.1%

3000D | Rf: 89.8 | Rg: 101.4

Color Vector Graphic

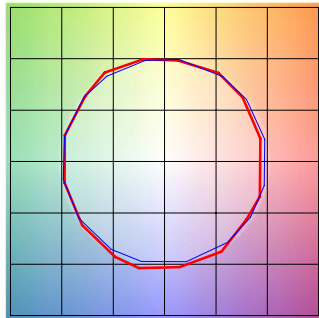

■ Test ■ Reference

GRAPHIC SHIFTS %			
HUE BIN	Rf	CHROMA	HUE
1	90.2	-4.2%	1.5%
2	90.9	-2.0%	3.7%
3	87.9	0.8%	5.5%
4	92.1	-0.9%	0.6%
5	93.0	1.5%	1.6%
6	92.2	3.9%	-0.2%
7	92.1	-0.3%	-2.0%
8	96.7	0.0%	-1.2%
9	92.5	-0.6%	3.7%
10	88.3	1.1%	7.0%
11	87.2	4.1%	7.4%
12	87.2	6.7%	-1.0%
13	88.2	3.8%	-7.2%
14	85.3	4.3%	-9.9%
15	90.9	-2.2%	-3.6%
16	83.4	-2.2%	-11.2%

2000K ONLY (2K4K) | Rf: 84.3 | Rg: 96.9

Color Vector Graphic

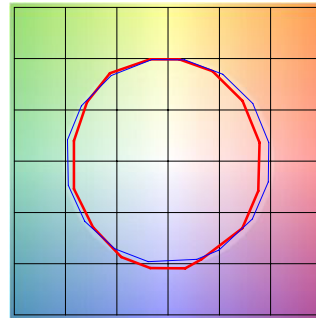

■ Test ■ Reference

GRAPHIC SHIFTS %			
HUE BIN	Rf	CHROMA	HUE
1	80.3	-8.9%	1.7%
2	79.7	-7.0%	7.8%
3	78.9	-2.9%	10.0%
4	89.5	-0.5%	5.1%
5	94.4	0.7%	1.7%
6	92.1	2.4%	-0.3%
7	89.4	-2.4%	-5.9%
8	89.7	-6.4%	-0.2%
9	86.0	-4.9%	4.6%
10	81.8	-3.4%	9.3%
11	83.1	3.3%	9.7%
12	85.8	5.6%	3.3%
13	85.6	6.2%	-12.8%
14	61.7	-1.9%	-19.0%
15	79.7	-3.3%	-12.9%
16	78.1	-7.9%	-10.6%

4000K ONLY (2K4K) | Rf: 89.6 | Rg: 99.1

Color Vector Graphic

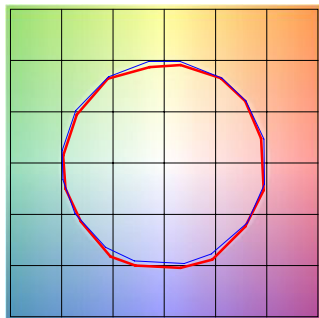

■ Test ■ Reference

GRAPHIC SHIFTS %			
HUE BIN	Rf	CHROMA	HUE
1	91.3	-2.5%	1.0%
2	95.3	-0.5%	0.5%
3	94.3	-0.7%	1.1%
4	91.1	-3.4%	-1.1%
5	89.5	-5.6%	0.0%
6	94.6	-1.4%	1.3%
7	93.2	-3.0%	2.6%
8	91.3	-1.8%	4.6%
9	86.5	-0.9%	9.1%
10	83.3	-0.5%	9.5%
11	83.3	4.9%	9.0%
12	89.7	4.1%	1.7%
13	90.1	3.6%	-4.3%
14	93.4	5.2%	-2.1%
15	87.4	0.4%	-4.3%
16	86.6	0.4%	-6.1%

2K4K (3000K) | Rf: 90.2 | Rg: 101.4

Color Vector Graphic

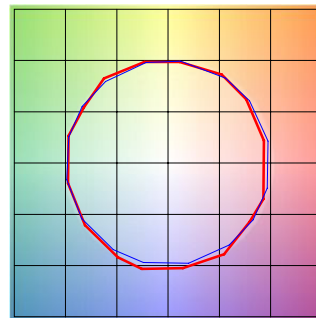

■ Test ■ Reference

GRAPHIC SHIFTS %			
HUE BIN	Rf	CHROMA	HUE
1	90.9	-3.8%	1.3%
2	91.7	-1.9%	3.3%
3	88.7	0.7%	5.1%
4	92.4	-1.0%	0.7%
5	92.9	0.9%	1.7%
6	93.1	3.3%	-0.6%
7	91.0	-1.8%	-0.4%
8	97.0	0.2%	-1.1%
9	92.8	-0.5%	3.6%
10	88.3	1.0%	7.0%
11	87.1	3.8%	7.8%
12	87.6	6.5%	-0.3%
13	89.3	3.6%	-6.3%
14	86.1	4.5%	-9.1%
15	91.6	-1.9%	-3.1%
16	83.8	-1.5%	-11.2%

PROJECT	FIXTURE TYPE	DATE
---------	--------------	------