

# NIO-2RTL

2" Iolite Round Trimless Adjustable with 10° Optic

Source: 12W  
800lm

Type

Project

Catalog No.

Notes

## PRODUCT DESCRIPTION

2" Trimless Iolite downlights have no exposed trim flange and do not extend beyond the ceiling plane. Iolite Trimless requires a Trimless Mud Ring and New Construction housing. Regressed cone reflector optimizes visual cut-off and adjust up to 15°.

## FEATURES

- Trimless knife edge appearance
- Delivering up to 8389 center beam candlepower (CBCP)
- 2700K, 3000K, 3500K, 4000K @ 90+ CRI
- 10° TIR optic delivers luminous intensity of higher lumen downlights
- 5-Year limited warranty

## SPECIFICATION

**Construction:** Trims are constructed of heat dissipating, die-cast aluminum. The aluminum die-cast LED heat sink is threaded to fit trimless downlight and transfer heat.

**Mounting:** Luminaire includes friction blades to mount securely to trimless mud ring. A trimless mud ring is required per trimless downlight.

## OPTIC

Each luminaire includes 10° TIR optic (Note: cannot be changed in the field)  
Luminaire is also available with field changeable optics, [Click Here](#) for more information.

## ELECTRICAL

**Lumens / Wattage:** 800lm / 12W  
**Color Temperature:** 2700K, 3000K, 3500K, 4000K  
**Color Rendering Index:** 90+ CRI  
**Operating Temperature:** Specified by housing  
**Lifetime:** 50,000 hours @ L70  
**Dimming:** Specified by housing

## COMPATIBLE HOUSINGS

Luminaires are compatible with respective Iolite housings manufactured by Nora Lighting.

CATALOG NO.	DESCRIPTION
<a href="#">NHIOICD-28LE4</a>	ICAT New Construction, 120-277V; Triac / ELV / 0-10V
<a href="#">NHIOICD-28LUPEQ</a>	ICAT New Construction, 120/277V; Lutron EcoSystem
<a href="#">NHIOICDCP-28LE4</a>	Chicago Plenum, 120-277V; Triac / ELV / 0-10V
<a href="#">NHIOICDCP-28LUPEQ</a>	Chicago Plenum, 120/277V; Lutron EcoSystem

**Accessories:** Luminaires can accommodate (1) hex louver and (1) translucent deco collar or opaque snoot, no accessory holder is required, see accessories page. A trimless mud ring is required per luminaire.

## LABELS AND LISTINGS

- cULus Listed for Damp Locations
- ENERGY STAR certified
- [5-Year Limited Warranty](#)
- RoHS Compliant
- Certified to the high efficacy requirements of California Title 24 JA8-2019



## Performance Data

Part Number	Lumens	CCT	CBCP
<b>NIO-2RTL400WW</b>	833lm	4000K	8389 cd

*Delivered lumens will vary depending on CCT and finish*

## PRODUCT IMAGES AND DIMENSIONS

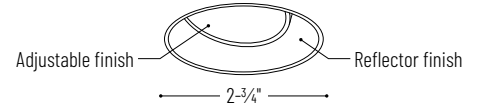

**NIO-2RTL**  
Round Trimless Adjustable  
15° Adjustable



**BB**  
Black Adjustable  
Black Reflector



**BW**  
Black Adjustable  
White Reflector



**BZ**  
Bronze Adjustable  
Bronze Reflector



**CH**  
Champagne Haze Adjustable  
Champagne Haze Reflector

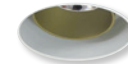

**CHMPW**  
Champagne Haze Adjustable  
Matte Powder White Reflector



**HW**  
Haze Adjustable  
White Reflector



**HZ**  
Haze Adjustable  
Haze Reflector



**HZMPW**  
Haze Adjustable  
Matte Powder White Reflector



**MPW**  
Matte Powder White Adjustable  
Matte Powder White Reflector



**WW**  
White Adjustable  
White Reflector

## 2" Iolite Round Trimless Adjustable with 10° Optic - New Construction Housing & Trimless Mud Ring Required

Type	Color Temperature	Finish
<b>NIO-2RTL</b> = Round Trimless Adjustable	<b>270</b> = 2700K	<b>BB</b> = Black
	<b>300</b> = 3000K	<b>BW</b> = Black / White
	<b>350</b> = 3500K	<b>BZ</b> = Bronze
	<b>400</b> = 4000K	<b>CH</b> = Champagne Haze
		<b>CHMPW</b> = Champagne Haze / Matte Powder White
		<b>HW</b> = Haze / White
		<b>HZ</b> = Haze
		<b>HZMPW</b> = Haze / Matte Powder White
		<b>MPW</b> = Matte Powder White
		<b>WW</b> = White

## Compatible Housings

Housing Type
<b>NHIOICD-28LE4</b> = ICAT New Construction; Triac / ELV / 0-10V
<b>NHIOICD-28LUPEQ</b> = ICAT New Construction; Lutron EcoSystem
<b>NHIOICDCP-28LE4</b> = Chicago Plenum; Triac / ELV / 0-10V
<b>NHIOICDCP-28LUPEQ</b> = Chicago Plenum; Lutron EcoSystem

## 2" Iolite Trimless Mud Ring

Description
<b>NIO-TLMR-2RA</b> = 2" Round Trimless Mud Ring

Example: **NIO-2RTL300WW / NIO-TLMR-2RA** = 2" Iolite Round Trimless Adjustable with 10° Optic, 3000K, White finish, / 2" Round Trimless Mud Ring

# 2" Iolite Accessories

## 2" Iolite Round Trimless Adjustable

Type
Project
Catalog No.
Notes

### ACCESSORIES

Iolite accessories can be added at any point in the design process. Accessories easily install between LED module and die-cast trim. Luminaire will accommodate (1) hex louver and (1) collar accessory, no accessory holder required.

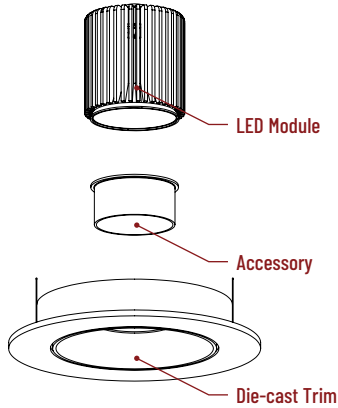

Translucent Decorative Collar

**NIO-AS14(color)**      5/8" length  
**NIO-AS19(color)**      3/4" length  
**NIO-AS26(color)**      1" length  
**Color:**  
**AM** (amber), **BLU** (blue), **FR** (frosted), **R** (red)

Translucent collars color the aperture with the specified color while producing white general light. Collars are available in different lengths. Use to add interest, create a theme, match a theme or define a space.



Opaque Collar Snoot

**NIO-AS14(color)**      5/8" length  
**NIO-AS19(color)**      3/4" length  
**NIO-AS26(color)**      1" length  
**Color:**  
**BLK** (black), **MPW** (matte powder white), **WH** (white)

Opaque snoot greatly reduces aperture brightness while preserving light output. (Note: Black snoot will reduce light)

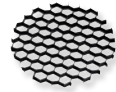

Hex Cell Louver

**NIO-HC**      Black  
 Hex cell louver subtly reduces aperture brightness by reducing light output by about 20%.

### TRIMLESS

2" Iolite trimless downlights have no exposed trim flange and the result is a minimalist knife edge appearance. A trimless mount mud ring is installed after the drywall and a professional drywall finisher floats the ceiling to blend in the mud ring.

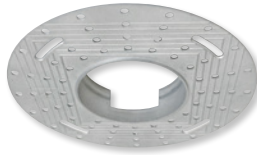
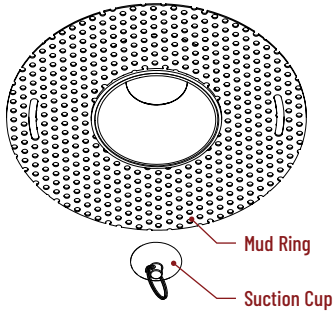

Trimless Mount Mud Ring

**NIO-TLMR-2RA**  
 Mounts trimless downlight with no exposed flange and no extension beyond ceiling plane. Mud ring attaches to drywall. **Only for use with NH10ICD-28 or NH10ICDCP-28 new construction housings and NIO-2RTLND or NIO-2RTLA.**  
 Dimensions: 7-7/8" diameter 1/2" thick



Suction Cup for Removal

**NIO-TLSUCTION**  
 Assist removing trimless reflector from finished ceiling after installation. For maintenance on trimless reflector.

# PHOTOMETRICS

## 2" Iolite Round Trimless Adjustable with 10° Optic

Type \_\_\_\_\_

Project \_\_\_\_\_

Catalog No. \_\_\_\_\_

Notes \_\_\_\_\_

### Test Information

Test Number: NTR1901R1  
 Part Number: NIO-2RTLA40QWW  
 Beam Spread: 12° Spot  
 Lumens: 833lm  
 Wattage: 12.42W  
 Efficacy: 67lpw  
 CCT / CRI: 4000K / 90 CRI  
 Spacing Criteria (0°-180°): 0.22  
 Spacing Criteria (90°-270°): 0.22

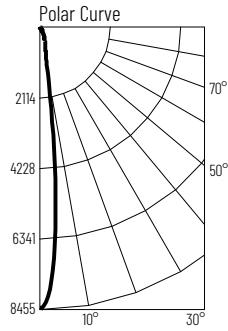

### Illuminance at a Distance

Distance from Luminaire	FC at Nadir	Beam Diameter
8'	131fc	1'-8"
10'	83.9fc	2'-2"
12'	58.3fc	2'-7"
14'	42.8fc	3'
16'	32.8fc	3'-5"

### Zonal Lumen Summary

Zone	Lumens	% Luminaire
0-30	706	84.7
0-40	782	93.9
0-60	821	98.6
0-90	833	100
90-180	0	0
0-180	833	100

### Candela Table

Vertical Angles	Candela
0	8389
5	5548
15	657
25	304
35	107
45	26

### Lumen Output Multipliers

Color Temperature: 2700K (0.9), 3000K (0.96), 3500K (0.96), 4000K (1.00)