

NIO-4PRTLA

4" Iolite PLUS Round Trimless Adjustable

Source: 20W or 24W LED

Up to 2200lm

Type

Project

Catalog No.

Notes

PRODUCT DESCRIPTION

4" PLUS Trimless Iolite downlights have no exposed flange and do not extend beyond the ceiling plane. Iolite PLUS Trimless requires a PLUS Trimless Mud Ring and New Construction housing. Deep regressed cone reflector optimizes visual cut-off and adjust up to 35°.

FEATURES

- Trimless knife edge appearance
- Delivering up to 2200lm LED packages
- 2700K, 3000K, 3500K, 4000K, 5000K @ 90+ CRI
- Flood optic, narrow flood and spot optics (included)
- 5-Year limited warranty

SPECIFICATION

Construction: Cold forged die-cast aluminum LED heat sink is threaded to fit trimless downlight and transfer heat.

Mounting: Luminaire includes stainless steel friction clips to mount securely to trimless mud ring. Mud ring is required per trimless downlight.

OPTICS

Each luminaire includes field changeable TIR optics (40° spot, 62° flood and 51° narrow flood - preinstalled).

ELECTRICAL

Delivered Lumens / Wattage	Up to 1850lm / 20W	Up to 2200lm / 24W
Color Temperature	2700K, 3000K, 3500K, 4000K, 5000K	
Color Rendering Index	90+ CRI	
Compatible Housing	NHIOICD-415 NHIOICDCP-415	NHIOICD-420 NHIOICDCP-420
Lifetime	50,000 hours @ L70	

Accessories: Luminaires will accommodate (1) translucent deco collar or opaque snoot, no accessory holder is required, see page 2. A mud ring ([NIO-TLMR-4PR](#)) or flange accessory ([NIO-4PRTEA](#)) is required per trimless.

LABELS AND LISTINGS

- cULus Listed for Damp Locations
- ENERGY STAR certified
- [5-Year Limited Warranty](#)
- RoHS Compliant
- Certified to the high efficacy requirements of California Title 24 JA8-2019



Performance Data

Optic	1500lm	2000lm	CCT
Spot	1618lm	1887lm	4000K
Narrow Flood	1875lm	2203lm	4000K
Flood	1274lm	1499lm	4000K

Delivered lumens will vary depending on optic, finish and CCT

PRODUCT IMAGES AND DIMENSIONS

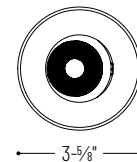
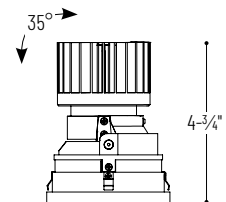

NIO-4PRTLA

PLUS Round Trimless Adjustable

Tilt: 35° / Rotation: 359°



BB

Black Adjustable



BZ

Bronze Adjustable



CH

Champagne Haze Adjustable



HZ

Haze Adjustable



MPW

Matte Powder White Adjustable



WW

White Adjustable

4" Iolite PLUS Round Trimless Adjustable - New Construction Housing & Trimless Mud Ring Required

Reflector Type	Color Temperature	Finish	Lumens / Wattage
NIO-4PRTLA = PLUS Round Trimless Adjustable	27X = 2700K	BB = Black	/HL = 1500lm or 2000lm (varies by housing)
	30X = 3000K	BZ = Bronze	
	35X = 3500K	CH = Champagne Haze	
	40X = 4000K	HZ = Haze	
	50X = 5000K	MPW = Matte Powder White WW = White	

Compatible Housings

Housing Type

- NHIOICD-415** = ICAT New Construction / 1500lm / 20W
- NHIOICDCP-415** = Chicago Plenum / 1500lm / 20W
- NHIOICD-420** = ICAT New Construction / 2000lm / 24W
- NHIOICDCP-420** = Chicago Plenum / 2000lm / 24W

4" PLUS Trimless Mud Ring

Description

NIO-TLMR-4PR = 4" PLUS Round Trimless Mud Ring

Example: **NIO-4PRTLA27XWW/HL** & **NIO-TLMR-4PR** = 4" Iolite PLUS Round Trimless Adjustable, 2700K, White finish / 4" PLUS Round Trimless Mud Ring

Iolite PLUS Accessories

4" Iolite PLUS Round Trimless Adjustable

Type
Project
Catalog No.
Notes

ACCESSORIES

Iolite accessories can be added at any point in the design process. Accessories easily install between LED module and die-cast trim. Luminaire will accommodate (1) hex lower and (1) collar accessory, no accessory holder required.

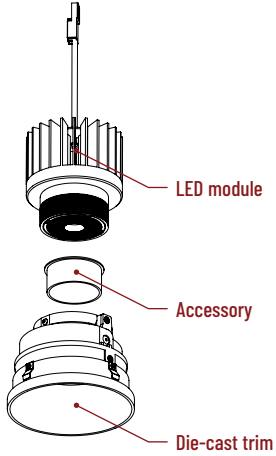

Translucent Decorative Collar

NIO-AS14(color) 5/8" length
NIO-AS19(color) 3/4" length
NIO-AS26(color) 1" length
Color:
AM (amber), **BLU** (blue), **FR** (frosted), **R** (red)

Translucent collars color the aperture with the specified color while producing white general light. Collars are available in different lengths. Use to add interest, create a theme, match a theme or define a space.



Opaque Collar Snoot

NIO-AS14(color) 5/8" length
NIO-AS19(color) 3/4" length
NIO-AS26(color) 1" length
Color:
BLK (black), **MPW** (matte powder white), **WH** (white)

Opaque snoot greatly reduces aperture brightness while preserving light output. (Note: Black snoot will reduce light)



Hex Cell Louver

NIO-HC Black
 Hex cell louver subtly reduces aperture brightness by reducing light output by about 20%.

TRIMLESS

4" Iolite PLUS trimless downlights have no exposed flange and the result is a minimalist knife edge appearance. A trimless mud ring is installed after the drywall and a professional drywall finisher floats the ceiling to blend in the mud ring.

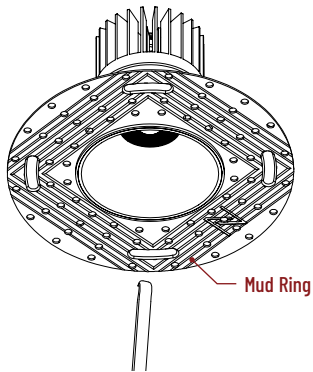

Iolite PLUS Trimless Mud Ring

NIO-TLMR-4PR Round Mud Ring

Mounts trimless downlight with no exposed flange and no extension beyond ceiling plane. Die-cast aluminum mud ring attaches to drywall. **Only for use with NHIOICD-4 new construction housings and NIO-4PRTL trimless.**
 Dimensions: 7-7/8" diameter 3/8" thick

FLANGE ACCESSORY

4" Iolite trimless can be converted into flanged trim. Flange accessory allows trim to be used with remodel and new construction housings. Accessory does not require mud ring or professional drywall installation.

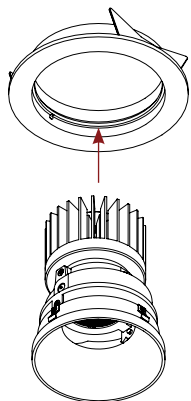

Flange Accessory

NIO-4RTFABB Black Flange
NIO-4RTFABZ Bronze Flange
NIO-4RTFACH Champagne Haze Flange
NIO-4RTFAHZ Haze Flange
NIO-4RTFAMPW Matte Powder White Flange
NIO-4RTFAWH White Flange

PHOTOMETRICS

4" Iolite PLUS Round Trimless Adjustable
1500 lumens

Type

Project

Catalog No.

Notes

Test Information

Test Number: NTR1710R1
Part Number: N10-4PRTLA40XMPW/HL
Beam Spread: 40° Spot
Lumens: 1618lm
Wattage: 19.63W
Efficacy: 82pw
CCT / CRI: 4000K / 90 CRI
Spacing Criteria (0°-180°): 0.66
Spacing Criteria (90°-270°): 0.68

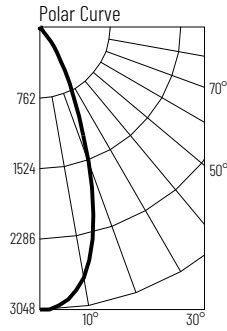

Illuminance at a Distance

Distance from Luminaire	FC at Nadir	Beam Diameter
8'	47.6fc	5'-10"
10'	30.5fc	7'-4"
12'	21.2fc	8'-10"
14'	15.5fc	10'-4"
16'	11.9fc	11'-8"

Zonal Lumen Summary

Zone	Lumens	% Luminaire
0-30	1332	82.4
0-40	1542	95.3
0-60	1594	98.5
0-90	1607	99.4
90-180	10	0.6
0-180	1618	100

Candela Table

Vertical Angles	Candela
0	3047
5	2953
15	2195
25	983
35	279
45	36

Test Information

Test Number: NTR1713R1
Part Number: N10-4PRTLA40XMPW/HL
Beam Spread: 51° Narrow Flood
Lumens: 1878lm
Wattage: 19.55W
Efficacy: 96pw
CCT / CRI: 4000K / 90 CRI
Spacing Criteria (0°-180°): 0.82
Spacing Criteria (90°-270°): 0.82

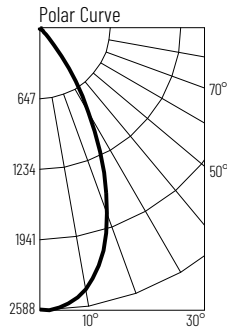

Illuminance at a Distance

Distance from Luminaire	FC at Nadir	Beam Diameter
8'	40.4fc	7'-8"
10'	25.9fc	9'-7"
12'	18fc	11'-7"
14'	13.2fc	13'-6"
16'	10.1fc	15'-5"

Zonal Lumen Summary

Zone	Lumens	% Luminaire
0-30	1454	77.4
0-40	1779	94.7
0-60	1852	98.6
0-90	1866	99.3
90-180	12	0.7
0-180	1878	100

Candela Table

Vertical Angles	Candela
0	2586
5	2532
15	2139
25	1373
35	522
45	67

Test Information

Test Number: NTR1716R1
Part Number: N10-4PRTLA40XMPW/HL
Beam Spread: 62° Flood
Lumens: 1274lm
Wattage: 19.48W
Efficacy: 65pw
CCT / CRI: 4000K / 90 CRI
Spacing Criteria (0°-180°): 1.00
Spacing Criteria (90°-270°): 0.96

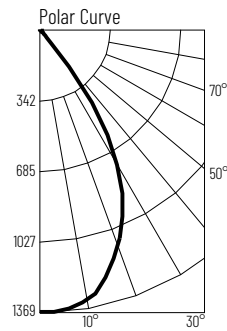

Illuminance at a Distance

Distance from Luminaire	FC at Nadir	Beam Diameter
8'	21.4fc	9'-10"
10'	13.7fc	12'-2"
12'	9.5fc	14'-8"
14'	7fc	17'-1"
16'	5.4fc	19'-6"

Zonal Lumen Summary

Zone	Lumens	% Luminaire
0-30	924	72.6
0-40	1183	92.9
0-60	1249	98.1
0-90	1265	99.4
90-180	8	0.6
0-180	1274	100

Candela Table

Vertical Angles	Candela
0	1369
5	1355
15	1262
25	1007
35	402
45	38

Lumen Output Multipliers

Color Temperature: 2700K (0.83), 3000K (0.89), 3500K (1.00), 4000K (1.00), 5000K (1.06)

PHOTOMETRICS

4" Iolite PLUS Round Trimless Adjustable
2000 lumens

Type

Project

Catalog No.

Notes

Test Information

Test Number: NTR1711R1
Part Number: NI0-4PRTLA40XMPW/HL
Beam Spread: 40° Spot
Lumens: 1887lm
Wattage: 23.8W
Efficacy: 79pw
CCT / CRI: 4000K / 90 CRI
Spacing Criteria (0°-180°): 0.66
Spacing Criteria (90°-270°): 0.68

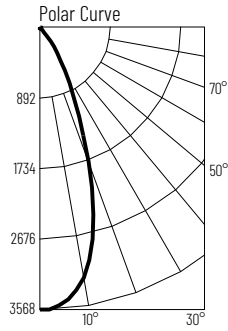

Illuminance at a Distance

Distance from Luminaire	FC at Nadir	Beam Diameter
12'	24.8fc	8'-10"
14'	18.2fc	10'-4"
16'	13.9fc	11'-8"
18'	11fc	13'-2"
20'	8.9fc	14'-8"

Zonal Lumen Summary

Zone	Lumens	% Luminaire
0-30	1557	82.5
0-40	1800	95.4
0-60	1859	98.5
0-90	1875	99.4
90-180	12	0.6
0-180	1887	100

Candela Table

Vertical Angles	Candela
0	3566
5	3457
15	2572
25	1145
35	323
45	42

Test Information

Test Number: NTR1714R1
Part Number: NI0-4PRTLA40XMPW/HL
Beam Spread: 51° Narrow Flood
Lumens: 2203lm
Wattage: 23.77W
Efficacy: 93pw
CCT / CRI: 4000K / 90 CRI
Spacing Criteria (0°-180°): 0.82
Spacing Criteria (90°-270°): 0.82

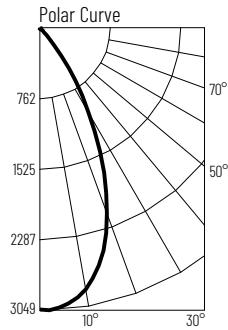

Illuminance at a Distance

Distance from Luminaire	FC at Nadir	Beam Diameter
12'	21.1fc	11'-7"
14'	15.5fc	13'-6"
16'	11.9fc	15'-5"
18'	9.4fc	17'-4"
20'	7.6fc	19'-4"

Zonal Lumen Summary

Zone	Lumens	% Luminaire
0-30	1709	77.6
0-40	2089	94.9
0-60	2173	98.7
0-90	2189	99.4
90-180	14	0.6
0-180	2203	100

Candela Table

Vertical Angles	Candela
0	3039
5	2973
15	2514
25	1613
35	616
45	79

Test Information

Test Number: NTR1717R1
Part Number: NI0-4PRTLA40XMPW/HL
Beam Spread: 62° Flood
Lumens: 1499lm
Wattage: 23.6W
Efficacy: 64pw
CCT / CRI: 4000K / 90 CRI
Spacing Criteria (0°-180°): 1.00
Spacing Criteria (90°-270°): 0.96

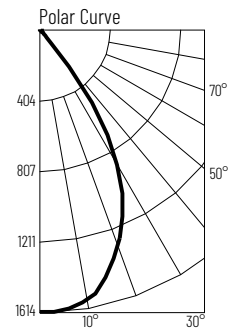

Illuminance at a Distance

Distance from Luminaire	FC at Nadir	Beam Diameter
12'	11.2fc	14'-8"
14'	8.2fc	17'-1"
16'	6.3fc	19'-6"
18'	5fc	22'
20'	4fc	24'-5"

Zonal Lumen Summary

Zone	Lumens	% Luminaire
0-30	1088	72.6
0-40	1394	93
0-60	1471	98.1
0-90	1490	99.4
90-180	9	0.6
0-180	1499	100

Candela Table

Vertical Angles	Candela
0	1612
5	1595
15	1486
25	1188
35	479
45	44

Lumen Output Multipliers

Color Temperature: 2700K (0.83), 3000K (0.89), 3500K (1.00), 4000K (1.00), 5000K (1.06)