

NIO-4RC

4" Iolite Round Adjustable Cone Reflector

Source: 14W to 28W LED
800lm to 2500lm

Type

Project

Catalog No.

Notes

PRODUCT DESCRIPTION

4" Iolite LED downlights require a dedicated Iolite new construction or remodel housing. Die-cast adjustable cone reflectors optimize visual cut-off and adjustable to aim the light source in desired direction.

FEATURES

- 800lm, 1000lm, 1500lm, 2000lm or 2500lm LED packages
- 2700K, 3000K, 3500K, 4000K, 5000K @ 90+ CRI
- Comfort Dim (warm dimming) also available in 800lm only
- Flood optic, narrow flood and spot optics (included)
- 5-Year limited warranty

SPECIFICATION

Construction: Trims are constructed of heat dissipating, die-cast aluminum. The aluminum die-cast LED heat sink is threaded to fit the trim and transfer heat.

Mounting: Luminaire includes friction blades to mount securely to housing.

OPTICS

800-1000lm: Three field changeable optics (spot, narrow flood and flood) are included with each LED module. Premium 10° TIR narrow spot optic assembly also available ([Click Here](#) for more information). Optional frosted and TIR optics are also available.

1500-2500lm: Three field changeable TIR optics (spot, narrow flood and flood) are included with each LED module.

ELECTRICAL

Lumens / Wattage: 800lm / 14W, 1000lm / 14W, 1500lm / 20W, 2000lm / 24W, 2500lm / 28W

Color Temperature: 2700K, 3000K, 3500K, 4000K, 5000K

Color Rendering Index: 90+ CRI

Operating Temperature: Specified by housing

Lifetime: 50,000 hours @ L70

Comfort Dim: Comfort Dim color tunes the temperature from a bright 3100K, to a romantic and comfortable 2000K on a gradual, even curve. Available in 800lm only.

Dimming: Specified by housing

COMPATIBLE HOUSINGS

Luminaires are compatible with respective Iolite housings manufactured by Nora Lighting.

CATALOG NO.	DESCRIPTION	LUMENS / WATTAGE
NHIOICD-48	ICAT New Construction	800-1000lm / 14W
NHIOICDCP-48	Chicago Plenum	800-1000lm / 14W
NHRIOIC-48	ICAT Remodel	800-1000lm / 14W
NHIOICD-415	ICAT New Construction	1500lm / 20W
NHIOICDCP-415	Chicago Plenum	1500lm / 20W
NHIOICD-420	ICAT New Construction	2000lm / 24W
NHIOICDCP-420	Chicago Plenum	2000lm / 24W
NHIOICD-425	ICAT New Construction	2500lm / 28W
NHIOICDCP-425	Chicago Plenum	2500lm / 28W

Accessories: Luminaires can accommodate (1) hex louver and (1) translucent deco collar or opaque snoot, no accessory holder is required, see accessories page. Flush mount mud ring is available to give the appearance of a trimless reflector, compatible with new construction housings only.

LABELS AND LISTINGS

- cULus Listed for Damp Locations
- ENERGY STAR certified
- [5-Year Limited Warranty](#)
- RoHS Compliant
- Certified to the high efficacy requirements of California Title 24 JA8-2019



PRODUCT IMAGES & DIMENSIONS

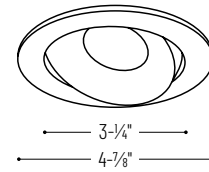

NIO-4RC

Round Adjustable Cone Regressed Reflector

Adjustability:

New Construction: 45° (800-1000lm) / 28° (1500-2500lm)

Remodel: 35° (800-1000lm)



BB
Black Reflector
Black Flange



BW
Black Reflector
White Flange

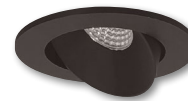

BZ
Bronze Reflector
Bronze Flange



CMPW
Specular Clear Reflector
Matte Powder White Flange



HW
Haze Reflector
White Flange



HZMPW
Haze Reflector
Matte Powder White Flange



MPW
Matte Powder White Reflector
Matte Powder White Flange

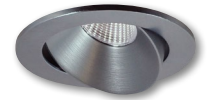

NN
Natural Metal Reflector
Natural Metal Flange



WW
White Reflector
White Flange

4" Iolite Round Adjustable Cone Reflector - Dedicated Housing Required

Reflector Type	Color Temp.	Finish	Lumens / Wattage
NIO-4RC = Round Adjustable Cone	50X = 5000K*	BB = Black / Black	(blank) = 800lm / 14W
	CDX = Comfort Dim [†]	BW = Black / White	
		BZ = Bronze / Bronze	
	27X = 2700K	CMPW = Specular Clear / Matte Powder White	/10 = 1000lm / 14W
	30X = 3000K	HW = Haze / White	/HL = 1500-2500lm
	35X = 3500K	HZMPW = Haze / Matte Powder White	(varies by housing)
	40X = 4000K	MPW = Matte Powder White	
	50X = 5000K	NN = Natural Metal / Natural Metal	
		WW = White / White	

* 5000K LED modules in 800lm are while supplies last

[†] Comfort Dim available in 800lm only and 1" Iolite uses a different dimming curve than 2" & 4" Iolite

Compatible Housings

Housing Type
NHIOICD-48 = ICAT New Construction / 800-1000lm / 14W
NHIOICDCP-48 = Chicago Plenum / 800-1000lm / 14W
NHRIOIC-48 = ICAT Remodel / 800-1000lm / 14W
NHIOICD-415 = ICAT New Construction / 1500lm / 20W
NHIOICDCP-415 = Chicago Plenum / 1500lm / 20W
NHIOICD-420 = ICAT New Construction / 2000lm / 24W
NHIOICDCP-420 = Chicago Plenum / 2000lm / 24W
NHIOICD-425 = ICAT New Construction / 2500lm / 28W
NHIOICDCP-425 = Chicago Plenum / 2500lm / 28W

Example: **NIO-4RC30XWW/10** = 4" Iolite Round Adjustable Cone Regress Reflector, 3000K, White finish, 1000lm / 14W

Iolite Accessories

4" Iolite Round Adjustable Cone Reflector

Type
Project
Catalog No.
Notes

FIELD CHANGEABLE OPTICS

Iolite luminaires include spot, narrow flood and flood optics. Optics can be changed in the field by removing LED module from die-cast trim. Optional frosted and TIR optics are also available.

Note: Frosted and Premium TIR optics are not compatible with /HL LED modules.

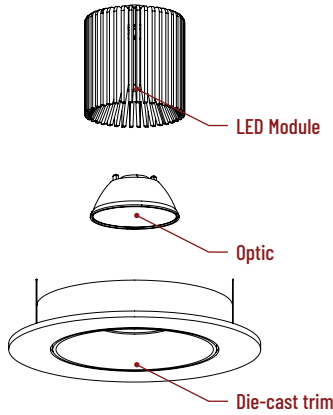

Frosted Filter-Optic

NIO-REFL38FR
NIO-REFL60FR

60° Optic
73° Optic

Not compatible with /HL LED module.



Premium TIR Optics

NIO-REFLTIR15
NIO-REFLTIR25

22° Optic
26° Optic

Not compatible with /HL or Comfort Dim (CDX) LED modules



10° TIR Optic Assembly

Specialized narrow spot LED module assembly is also available. Requires LE4 housing. [Click Here](#) for more information.

ACCESSORIES

Iolite accessories can be added at any point in the design process. Accessories easily install between LED module and die-cast trim.

Luminaire will accommodate (1) hex louver and (1) collar accessory, no accessory holder required.

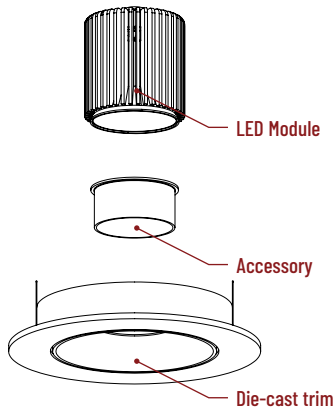

Translucent Decorative Collar

NIO-AS14(color) 5/8" length
NIO-AS19(color) 3/4" length
NIO-AS26(color) 1" length
Color:
AM (amber), **BLU** (blue), **FR** (frosted), **R** (red)

Translucent collars color the aperture with the specified color while producing white general light. Collars are available in different lengths. Use to add interest, create a theme, match a theme or define a space.



Opaque Collar Snoot

NIO-AS14(color) 5/8" length
NIO-AS19(color) 3/4" length
NIO-AS26(color) 1" length
Color:
BLK (black), **MPW** (matte powder white), **WH** (white)

Opaque snoot greatly reduces aperture brightness while preserving light output. (Note: Black snoot will reduce light)



Hex Cell Louver

NIO-HC Black
Hex cell louver subtly reduces aperture brightness by reducing light output by about 20%.

FLUSH MOUNT

4" Iolite trims can be installed flush with the drywall for a flush mount appearance. A flush mount mud ring is installed after the drywall and a professional drywall finisher floats the ceiling to blend in the mud ring.

Flush Mount Mud Ring

NIO-FMMR-4R Round Mud Ring

Mounts reflector flush to ceiling with flange visible. Mud ring attaches to drywall. **Only for use with NHIOICD-48 or NHIOICDCP-48 new construction housings and NIO-4R trims.** Dimensions: 7-7/8" diameter 1/2" thick



PHOTOMETRICS

4" Iolite Round Adjustable Cone Reflector
800 lumens

Type

Project

Catalog No.

Notes

Test Information

Test Number: NTR1338
Part Number: N10-4RC40XWW
Beam Spread: 26° Spot
Lumens: 1294lm
Wattage: 13.96W
Efficacy: 93pw
CCT / CRI: 4000K / 90 CRI
Spacing Criteria (0°-180°): 0.44
Spacing Criteria (90°-270°): 0.46

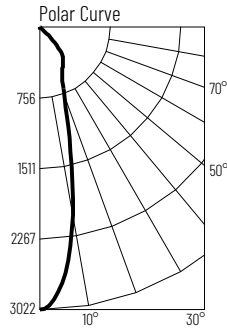

Illuminance at a Distance

Distance from Luminaire	FC at Nadir	Beam Diameter
4'	187fc	1'-10"
6'	83.3fc	2'-10"
8'	46.9fc	3'-8"
10'	30fc	4'-7"
12'	20.8fc	5'-6"

Zonal Lumen Summary

Zone	Lumens	% Luminaire
0-30	844	65.2
0-40	1111	85.9
0-60	1281	99
0-90	1292	99.9
90-180	2	0.1
0-180	1294	100

Candela Table

Vertical Angles	Candela
0	3000
5	2700
15	1193
25	556
35	426
45	194

Test Information

Test Number: NTR1339
Part Number: N10-4RC40XWW
Beam Spread: 39° Narrow Flood
Lumens: 1329lm
Wattage: 13.98W
Efficacy: 95pw
CCT / CRI: 4000K / 90 CRI
Spacing Criteria (0°-180°): 0.64
Spacing Criteria (90°-270°): 0.66

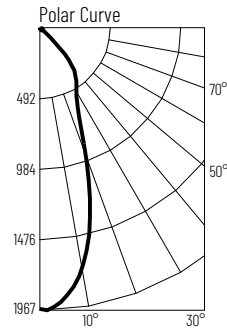

Illuminance at a Distance

Distance from Luminaire	FC at Nadir	Beam Diameter
4'	123fc	2'-10"
6'	54.7fc	4'-2"
8'	30.7fc	5'-7"
10'	19.7fc	7'
12'	13.7fc	8'-5"

Zonal Lumen Summary

Zone	Lumens	% Luminaire
0-30	848	63.9
0-40	1125	84.6
0-60	1304	98.2
0-90	1323	99.6
90-180	6	0.4
0-180	1329	100

Candela Table

Vertical Angles	Candela
0	1967
5	1876
15	1342
25	637
35	441
45	195

Test Information

Test Number: NTR1340
Part Number: N10-4RC40XWW
Beam Spread: 61° Flood
Lumens: 1348lm
Wattage: 14.07W
Efficacy: 96pw
CCT / CRI: 4000K / 90 CRI
Spacing Criteria (0°-180°): 0.86
Spacing Criteria (90°-270°): 0.88

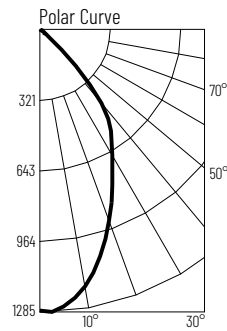

Illuminance at a Distance

Distance from Luminaire	FC at Nadir	Beam Diameter
4'	79.8fc	4'-8"
6'	35.5fc	7'
8'	19.9fc	9'-5"
10'	12.8fc	11'-8"
12'	8.9fc	14'

Zonal Lumen Summary

Zone	Lumens	% Luminaire
0-30	768	57
0-40	1081	80.2
0-60	1319	97.9
0-90	1343	99.6
90-180	6	0.4
0-180	1348	100

Candela Table

Vertical Angles	Candela
0	1276
5	1244
15	1050
25	768
35	553
45	222

Lumen Output Multipliers

Color Temperature: 2700K (0.83), 3000K (0.86), 3500K (0.89), 4000K (1.00), 5000K (1.01)

PHOTOMETRICS

4" Iolite Round Adjustable Cone Reflector 1000 lumens

Type

Project

Catalog No.

Notes

Test Information

Test Number: NTR1368
Part Number: NI0-4RC40XWW/10
Beam Spread: 26° Spot
Lumens: 1484lm
Wattage: 13.41W
Efficacy: 111pw
CCT / CRI: 4000K / 90 CRI
Spacing Criteria (0°-180°): 0.46
Spacing Criteria (90°-270°): 0.46

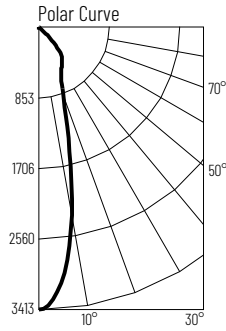

Illuminance at a Distance

Distance from Luminaire	FC at Nadir	Beam Diameter
4'	213fc	1'-11"
6'	94.8fc	2'-10"
8'	53.3fc	3'-8"
10'	34.1fc	4'-8"
12'	23.7fc	5'-7"

Zonal Lumen Summary

Zone	Lumens	% Luminaire
0-30	968	65.2
0-40	1274	85.9
0-60	1471	99.1
0-90	1482	99.9
90-180	2	0.1
0-180	1484	100

Candela Table

Vertical Angles	Candela
0	3413
5	3107
15	1389
25	648
35	495
45	222

Test Information

Test Number: NTR1369
Part Number: NI0-4RC40XWW/10
Beam Spread: 38° Narrow Flood
Lumens: 1482lm
Wattage: 13.5W
Efficacy: 110pw
CCT / CRI: 4000K / 90 CRI
Spacing Criteria (0°-180°): 0.64
Spacing Criteria (90°-270°): 0.66

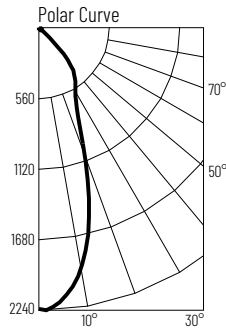

Illuminance at a Distance

Distance from Luminaire	FC at Nadir	Beam Diameter
4'	139fc	2'-10"
6'	61.9fc	4'-2"
8'	34.8fc	5'-6"
10'	22.3fc	6'-11"
12'	15.5fc	8'-4"

Zonal Lumen Summary

Zone	Lumens	% Luminaire
0-30	953	64.3
0-40	1235	83.3
0-60	1462	98.7
0-90	1480	99.8
90-180	2	0.2
0-180	1482	100

Candela Table

Vertical Angles	Candela
0	2228
5	2133
15	1512
25	707
35	499
45	218

Test Information

Test Number: NTR1370
Part Number: NI0-4RC40XWW/10
Beam Spread: 61° Flood
Lumens: 1500lm
Wattage: 13.47W
Efficacy: 111pw
CCT / CRI: 4000K / 90 CRI
Spacing Criteria (0°-180°): 0.86
Spacing Criteria (90°-270°): 0.88

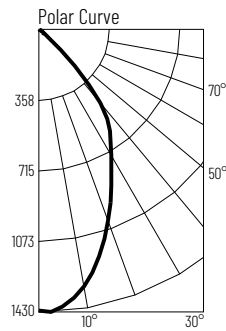

Illuminance at a Distance

Distance from Luminaire	FC at Nadir	Beam Diameter
4'	88.9fc	4'-8"
6'	39.5fc	7'
8'	22.2fc	9'-5"
10'	14.2fc	11'-8"
12'	9.9fc	14'

Zonal Lumen Summary

Zone	Lumens	% Luminaire
0-30	855	57
0-40	1239	82.6
0-60	1468	97.9
0-90	1494	99.6
90-180	6	0.4
0-180	1500	100

Candela Table

Vertical Angles	Candela
0	1423
5	1392
15	1174
25	854
35	619
45	247

Lumen Output Multipliers

Color Temperature: 2700K (0.82), 3000K (0.84), 3500K (0.92), 4000K (1.00), 5000K (0.97)

PHOTOMETRICS

4" Iolite Round Adjustable Cone Reflector 1500 lumens

Type

Project

Catalog No.

Notes

Test Information

Test Number: NTR1273R1
Part Number: N10-4RC40XWW/HL
Beam Spread: 39° Spot
Lumens: 2113lm
Wattage: 19.91W
Efficacy: 106pw
CCT / CRI: 4000K / 90 CRI
Spacing Criteria (0°-180°): 0.64
Spacing Criteria (90°-270°): 0.66

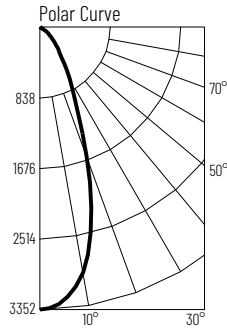

Illuminance at a Distance

Distance from Luminaire	FC at Nadir	Beam Diameter
6'	93fc	4'-4"
8'	52.3fc	5'-8"
10'	33.5fc	7'-1"
12'	23.3fc	8'-6"
14'	17.1fc	9'-11"

Zonal Lumen Summary

Zone	Lumens	% Luminaire
0-30	1435	67.9
0-40	1751	82.9
0-60	2055	97.3
0-90	2104	99.6
90-180	9	0.4
0-180	2113	100

Candela Table

Vertical Angles	Candela
0	3349
5	3234
15	2311
25	1058
35	494
45	247

Test Information

Test Number: NTR1244R1
Part Number: N10-4RC40XWW/HL
Beam Spread: 51° Narrow Flood
Lumens: 2219lm
Wattage: 19.9W
Efficacy: 111pw
CCT / CRI: 4000K / 90 CRI
Spacing Criteria (0°-180°): 0.8
Spacing Criteria (90°-270°): 0.82

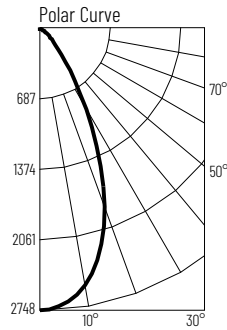

Illuminance at a Distance

Distance from Luminaire	FC at Nadir	Beam Diameter
6'	76.3fc	5'-8"
8'	42.9fc	7'-6"
10'	27.5fc	9'-5"
12'	19.1fc	11'-4"
14'	14fc	13'-2"

Zonal Lumen Summary

Zone	Lumens	% Luminaire
0-30	1524	68.7
0-40	1904	85.8
0-60	2167	97.7
0-90	2209	99.6
90-180	10	0.4
0-180	2219	100

Candela Table

Vertical Angles	Candela
0	2748
5	2691
15	2254
25	1402
35	590
45	218

Test Information

Test Number: NTR1279R1
Part Number: N10-4RC40XWW/HL
Beam Spread: 71° Flood
Lumens: 1937lm
Wattage: 19.85W
Efficacy: 98pw
CCT / CRI: 4000K / 90 CRI
Spacing Criteria (0°-180°): 1.02
Spacing Criteria (90°-270°): 1.04

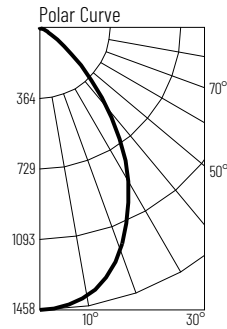

Illuminance at a Distance

Distance from Luminaire	FC at Nadir	Beam Diameter
6'	40.5fc	8'-6"
8'	22.8fc	11'-5"
10'	14.6fc	14'-2"
12'	10.1fc	17'
14'	7.4fc	19'-11"

Zonal Lumen Summary

Zone	Lumens	% Luminaire
0-30	1010	52.1
0-40	1434	74
0-60	1871	96.5
0-90	1929	99.5
90-180	9	0.5
0-180	1937	100

Candela Table

Vertical Angles	Candela
0	1456
5	1441
15	1335
25	1084
35	745
45	360

Lumen Output Multipliers

Color Temperature: 2700K (0.83), 3000K (0.89), 3500K (1.00), 4000K (1.00), 5000K (1.06)

PHOTOMETRICS

4" Iolite Round Adjustable Cone Reflector 2000 lumens

Type

Project

Catalog No.

Notes

Test Information

Test Number: NTR1274R1
Part Number: N10-4RC40XWW/HL
Beam Spread: 39° Spot
Lumens: 2420lm
Wattage: 23.94W
Efficacy: 101pw
CCT / CRI: 4000K / 90 CRI
Spacing Criteria (0°-180°): 0.64
Spacing Criteria (90°-270°): 0.66

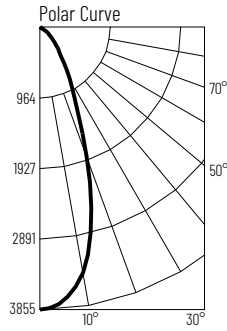

Illuminance at a Distance

Distance from Luminaire	FC at Nadir	Beam Diameter
8'	60fc	4'-2"
10'	38.4fc	5'-7"
12'	26.7fc	7'-1"
14'	19.6fc	9'-11"
16'	15fc	11'-4"

Zonal Lumen Summary

Zone	Lumens	% Luminaire
0-30	1642	67.8
0-40	2004	82.8
0-60	2354	97.3
0-90	2410	99.6
90-180	11	0.4
0-180	2420	100

Candela Table

Vertical Angles	Candela
0	3841
5	3688
15	2627
25	1206
35	565
45	283

Test Information

Test Number: NTR1275R1
Part Number: N10-4RC40XWW/HL
Beam Spread: 51° Narrow Flood
Lumens: 2549lm
Wattage: 24W
Efficacy: 106pw
CCT / CRI: 4000K / 90 CRI
Spacing Criteria (0°-180°): 0.8
Spacing Criteria (90°-270°): 0.82

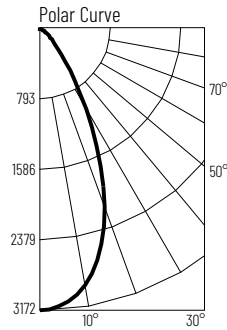

Illuminance at a Distance

Distance from Luminaire	FC at Nadir	Beam Diameter
8'	49.4fc	7'-6"
10'	31.6fc	9'-5"
12'	22fc	11'-2"
14'	16.1fc	11'
16'	12.4fc	15'

Zonal Lumen Summary

Zone	Lumens	% Luminaire
0-30	1752	68.7
0-40	2188	85.8
0-60	2491	97.7
0-90	2538	99.6
90-180	11	0.4
0-180	2549	100

Candela Table

Vertical Angles	Candela
0	3162
5	3091
15	2585
25	1604
35	675
45	248

Test Information

Test Number: NTR1280R1
Part Number: N10-4RC40XWW/HL
Beam Spread: 71° Flood
Lumens: 2266lm
Wattage: 24.19W
Efficacy: 94pw
CCT / CRI: 4000K / 90 CRI
Spacing Criteria (0°-180°): 1.02
Spacing Criteria (90°-270°): 1.04

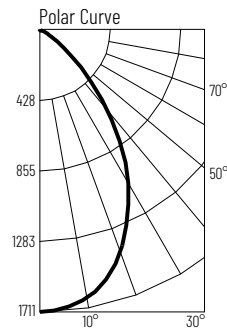

Illuminance at a Distance

Distance from Luminaire	FC at Nadir	Beam Diameter
8'	26.7fc	11'-4"
10'	17.1fc	14'-2"
12'	11.9fc	17'
14'	8.7fc	19'-11"
16'	6.7fc	22'-8"

Zonal Lumen Summary

Zone	Lumens	% Luminaire
0-30	1182	52.2
0-40	1678	74
0-60	2188	96.5
0-90	2256	99.5
90-180	10	0.5
0-180	2266	100

Candela Table

Vertical Angles	Candela
0	1707
5	1690
15	1645
25	1271
35	874
45	422

Lumen Output Multipliers

Color Temperature: 2700K (0.84), 3000K (0.87), 3500K (0.99), 4000K (1.00), 5000K (1.07)

PHOTOMETRICS

4" Iolite Round Adjustable Cone Reflector 2500 lumens

Type

Project

Catalog No.

Notes

Test Information

Test Number: NTR1275R1
Part Number: N10-4RC40XWW/HL
Beam Spread: 39° Spot
Lumens: 2712lm
Wattage: 27.74W
Efficacy: 98pw
CCT / CRI: 4000K / 90 CRI
Spacing Criteria (0°-180°): 0.64
Spacing Criteria (90°-270°): 0.66

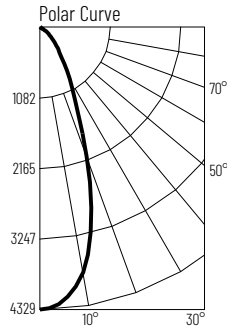

Illuminance at a Distance

Distance from Luminaire	FC at Nadir	Beam Diameter
10'	43.1fc	7'-1"
12'	30fc	8'-6"
14'	22fc	9'-11"
16'	16.8fc	11'-4"
18'	13.3fc	12'-8"

Zonal Lumen Summary

Zone	Lumens	% Luminaire
0-30	1842	67.9
0-40	2247	82.9
0-60	2637	97.3
0-90	2700	99.6
90-180	12	0.4
0-180	2712	100

Candela Table

Vertical Angles	Candela
0	4313
5	4138
15	2952
25	1349
35	630
45	315

Test Information

Test Number: NTR1276R1
Part Number: N10-4RC40XWW/HL
Beam Spread: 51° Narrow Flood
Lumens: 2897lm
Wattage: 27.81W
Efficacy: 104pw
CCT / CRI: 4000K / 90 CRI
Spacing Criteria (0°-180°): 0.8
Spacing Criteria (90°-270°): 0.82

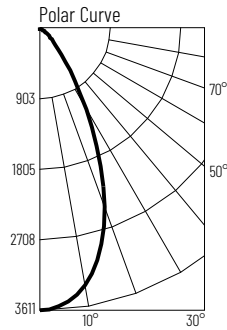

Illuminance at a Distance

Distance from Luminaire	FC at Nadir	Beam Diameter
10'	36fc	9'-4"
12'	25fc	11'-2"
14'	18.3fc	13'-1"
16'	14fc	15'
16'	11.1fc	16'-10"

Zonal Lumen Summary

Zone	Lumens	% Luminaire
0-30	1989	68.7
0-40	2485	85.8
0-60	2830	97.7
0-90	2884	99.6
90-180	13	0.4
0-180	2897	100

Candela Table

Vertical Angles	Candela
0	3596
5	3507
15	2930
25	1818
35	761
45	280

Test Information

Test Number: NTR1281R1
Part Number: N10-4RC40XWW/HL
Beam Spread: 71° Flood
Lumens: 2519lm
Wattage: 27.68W
Efficacy: 91pw
CCT / CRI: 4000K / 90 CRI
Spacing Criteria (0°-180°): 1.02
Spacing Criteria (90°-270°): 1.04

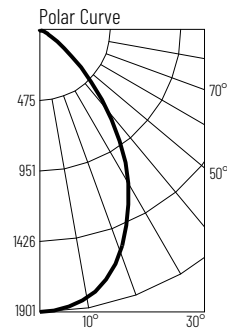

Illuminance at a Distance

Distance from Luminaire	FC at Nadir	Beam Diameter
10'	19fc	14'-2"
12'	13.2fc	17'
14'	9.7fc	19'-10"
16'	7.4fc	22'-8"
16'	5.9fc	25'-6"

Zonal Lumen Summary

Zone	Lumens	% Luminaire
0-30	1313	52.1
0-40	1864	74
0-60	2432	96.5
0-90	2508	99.6
90-180	11	0.4
0-180	2519	100

Candela Table

Vertical Angles	Candela
0	1899
5	1875
15	1735
25	1410
35	969
45	466

Lumen Output Multipliers

Color Temperature: 2700K (0.82), 3000K (0.89), 3500K (0.99), 4000K (1.00), 5000K (1.05)