

NIO-4SD

4" Iolite Square Deep Adjustable Reflector with 10° Optic

Source: 12W
850lm

PRODUCT DESCRIPTION

4" Iolite luminaires can be specified for use with Iolite new construction or remodel housings. Die-cast adjustable reflectors optimize visual cut-off and adjustable to aim the light source in desired direction.

FEATURES

- Delivering up to 9038 center beam candlepower (CBCP)
- 2700K, 3000K, 3500K, 4000K @ 90+ CRI
- 10° TIR optic delivers luminous intensity of higher lumen downlights
- 5-Year limited warranty

SPECIFICATION

Construction: Trims are constructed of heat dissipating, die-cast aluminum. The aluminum die-cast LED heat sink is threaded to fit the trim and transfer heat.

Mounting: Trim includes friction blades to mount securely to housing.

OPTIC

Each luminaire includes 10° TIR optic (Note: cannot be changed in the field)
Luminaire is also available with field changeable optics, [Click Here](#) for more information.

ELECTRICAL

Lumens / Wattage: 850lm / 12W
Color Temperature: 2700K, 3000K, 3500K, 4000K
Color Rendering Index: 90+CRI
Operating Temperature: Specified by housing
Lifetime: 50,000 hours @ L70
Dimming: Specified by housing

COMPATIBLE HOUSINGS

Luminaires are compatible with respective Iolite housings manufactured by Nora Lighting.

CATALOG NO.	DESCRIPTION
NHIOICD-48LE4	ICAT New Construction, 120-277V; Triac / ELV / 0-10V
NHIOICD-48LUPEQ	ICAT New Construction, 120/277V; Lutron EcoSystem
NHIOICDCP-48LE4	Chicago Plenum, 120-277V; Triac / ELV / 0-10V
NHIOICDCP-48LUPEQ	Chicago Plenum, 120/277V; Lutron EcoSystem
NHRIOIC-48LE4	ICAT Remodel, 120-277V; Triac / ELV / 0-10V

Accessories: Luminaires can accommodate (1) hex louver and (1) translucent deco collar or opaque snoot, no accessory holder is required, see accessories page. Flush mount mud ring is available to give the appearance of trimless, compatible with new construction housings only.

LABELS AND LISTINGS

- cULus Listed for Damp Locations
- ENERGY STAR certified
- [5-Year Limited Warranty](#)
- RoHS Compliant
- Certified to the high efficacy requirements of California Title 24 JA8-2019



Type

Project

Catalog No.

Notes

Performance Data

Part Number	Lumens	CCT	CBCP
NIO-4RD40QWW	874lm	4000K	9038 cd

Delivered lumens will vary depending on CCT and finish

PRODUCT IMAGES & DIMENSIONS

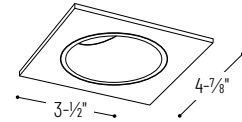

NIO-4SD

Square Deep Adjustable Reflector

Adjustability:

New Construction: 40° / Remodel: 25°

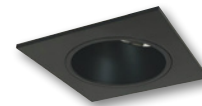

BB

Black Reflector
Black Flange



BW

Black Reflector
White Flange

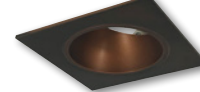

BZ

Bronze Reflector
Bronze Flange

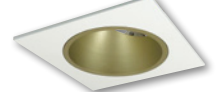

CHMPW

Champagne Haze Reflector
Matte Powder White Flange



HW

Haze Reflector
White Flange



HZMPW

Haze Reflector
Matte Powder White Flange



MPW

Matte Powder White Reflector
Matte Powder White Flange



NN

Natural Metal Reflector
Natural Metal Flange



WW

White Reflector
White Flange

4" Iolite Square Deep Adjustable Reflector with 10° Optic - Dedicated Housing Required

Type	Color Temperature	Finish
NIO-4SD = Square Deep Adjustable	270 = 2700K	BB = Black / Black
	300 = 3000K	BW = Black / White
	350 = 3500K	BZ = Bronze / Bronze
	400 = 4000K	CHMPW = Champagne / Matte Powder White
		HW = Haze / White
		HZMPW = Haze / Matte Powder White
		MPW = Matte Powder White
		NN = Natural Metal / Natural Metal
		WW = White / White

Compatible Housings

Housing Type
NHIOICD-48LE4 = ICAT New Construction; Triac / ELV / 0-10V
NHIOICD-48LUPEQ = ICAT New Construction; Lutron EcoSystem
NHIOICDCP-48LE4 = Chicago Plenum; Triac / ELV / 0-10V
NHIOICDCP-48LUPEQ = Chicago Plenum; Lutron EcoSystem
NHRIOIC-48LE4 = ICAT Remodel; Triac / ELV / 0-10V

Example: **NIO-4SD40QWW** = 4" Iolite Square Deep Adjustable with 10° Optic, 4000K, White finish

4" Iolite Accessories

4" Iolite Square Deep Adjustable Reflector with 10° Optic

Type
Project
Catalog No.
Notes

ACCESSORIES

Iolite accessories can be added at any point in the design process. Accessories easily install between LED module and die-cast trim. Luminaire will accommodate (1) hex louver and (1) collar accessory, no accessory holder required.

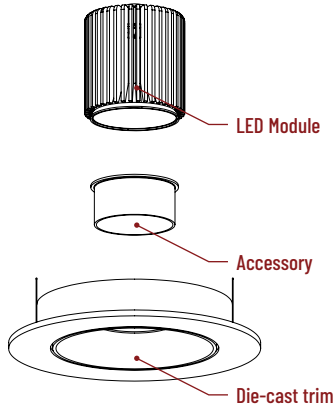

Translucent Decorative Collar

NIO-AS14(color) 5/8" length
NIO-AS19(color) 3/4" length
NIO-AS26(color) 1" length
Color:
AM (amber), **BLU** (blue), **FR** (frosted), **R** (red)

Translucent collars color the aperture with the specified color while producing white general light. Collars are available in different lengths. Use to add interest, create a theme, match a theme or define a space.



Opaque Collar Snoot

NIO-AS14(color) 5/8" length
NIO-AS19(color) 3/4" length
NIO-AS26(color) 1" length
Color:
BLK (black), **MPW** (matte powder white), **WH** (white)

Opaque snoot greatly reduces aperture brightness while preserving light output. (Note: Black snoot will reduce light)

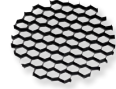

Hex Cell Louver

NIO-HC Black
 Hex cell louver subtly reduces aperture brightness by reducing light output by about 20%.

FLUSH MOUNT

4" Iolite trims can be installed flush with the drywall for a flush mount appearance. A flush mount mud ring is installed after the drywall and a professional drywall finisher floats the ceiling to blend in the mud ring.



Flush Mount Mud Ring

NIO-FMMR-4S Square Mud Ring

Mounts trim flush to ceiling with flange visible. Mud ring attaches to drywall. **Only for use with NH10ICD-48 or NH10ICDCP-48 new construction housings and NIO-4S trims.**
 Dimensions: 7-7/8" diameter 1/2" thick

PHOTOMETRICS

4" Iolite Square Deep Adjustable Reflector with 10° Optic

Type _____

Project _____

Catalog No. _____

Notes _____

Test Information

Test Number: NTR1892R1
 Part Number: NIO-4SD40QWW
 Beam Spread: 12° Spot
 Lumens: 874lm
 Wattage: 12.42W
 Efficacy: 70lpw
 CCT / CRI: 4000K / 90 CRI
 Spacing Criteria (0°-180°): 0.22
 Spacing Criteria (90°-270°): 0.22

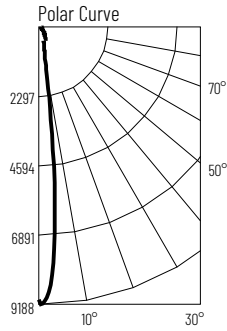

Illuminance at a Distance

Distance from Luminaire	FC at Nadir	Beam Diameter
6'	251fc	1'-4"
8'	141fc	1'-8"
10'	90.4fc	2'-1"
12'	62.8fc	2'-7"
14'	46.1fc	3'

Zonal Lumen Summary

Zone	Lumens	% Luminaire
0-30	764	87.3
0-40	838	95.8
0-60	863	98.6
0-90	874	100
90-180	0	0
0-180	874	100

Candela Table

Vertical Angles	Candela
0	9038
5	5946
15	715
25	316
35	76
45	15

Lumen Output Multipliers

Color Temperature: 2700K (0.9), 3000K (0.96), 3500K (0.96), 4000K (1.00)