

NI0B-2SC

2" Iolite Square Adjustable Cone Reflector

Source: 14W to 28W LED
800lm to 2500lm

Type

Project

Catalog No.

Notes

PRODUCT DESCRIPTION

2" Iolite downlights can be specified for use in new construction or remodel applications. Die-cast adjustable cone reflectors optimize visual cut-off and adjustable to aim the light source in desired direction.

FEATURES

- 800lm, 1000lm, 1500lm, 2000lm or 2500lm LED packages
- 2700K, 3000K, 3500K, 4000K, 5000K @ 90+ CRI
- Comfort Dim (warm dimming) also available in 800lm only
- Flood optic, narrow flood and spot optics (included)
- 5-Year limited warranty

SPECIFICATION

Construction: Trims are constructed of heat dissipating, die-cast aluminum. The aluminum die-cast LED heat sink is threaded to fit the reflector and transfer heat.

Mounting: Reflector includes friction blades to mount securely to housing.

OPTICS

800-1000lm: Three field changeable optics (spot, narrow flood and flood) are included with each LED module. Premium 10° TIR narrow spot optic assembly also available ([Click Here](#) for more information). Optional frosted and TIR optics are also available.

1500-2500lm: Three field changeable TIR optics (spot, narrow flood and flood) are included with each LED module.

ELECTRICAL

Lumens / Wattage: 800lm / 14W, 1000lm / 14W, 1500lm / 20W, 2000lm / 24W, 2500lm / 28W

Color Temperature: 2700K, 3000K, 3500K, 4000K, 5000K

Color Rendering Index: 90+CRI

Operating Temperature: 0°C to 40°C ambient temperature

Lifetime: 50,000 hours @ L70

Comfort Dim: Comfort Dim color tunes the temperature from a bright 3100K, to a romantic and comfortable 2000K on a gradual, even curve. Available in 800lm only.

Dimming: Specified by housing

COMPATIBLE HOUSINGS

Luminaires are compatible with respective Iolite housings manufactured by Nora Lighting.

CATALOG NO.	DESCRIPTION	LUMENS / WATTAGE
NHIOICD-28	ICAT New Construction	800-1000lm / 14W
NHIOICDCP-28	Chicago Plenum	800-1000lm / 14W
NHRIOIC-28	ICAT Remodel	800-1000lm / 14W
NHIOICD-215	ICAT New Construction	1500lm / 20W
NHIOICDCP-215	Chicago Plenum	1500lm / 20W
NHIOICD-220	ICAT New Construction	2000lm / 24W
NHIOICDCP-220	Chicago Plenum	2000lm / 24W
NHIOICD-225	ICAT New Construction	2500lm / 28W
NHIOICDCP-225	Chicago Plenum	2500lm / 28W

Accessories: Luminaires will accommodate (1) hex louver and (1) translucent deco collar or opaque snoot, no accessory holder is required, see accessories page. Flush mount mud ring is available to give the appearance of a trimless reflector, compatible with new construction housing only.

LABELS AND LISTINGS

- cULus Listed for Damp Locations
- ENERGY STAR certified
- 5-Year Limited Warranty
- RoHS Compliant
- Certified to the high efficacy requirements of California Title 24 JA8-2019



PRODUCT IMAGES & DIMENSIONS

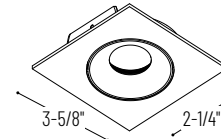

NI0B-2SC

Square Cone Regressed
Adjustability:

New Construction: 15° (800-2500lm)
Remodel: 10° (800-1000lm)



BB
Black Reflector
Black Flange



BW
Black Reflector
White Flange

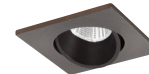

BZ
Bronze Reflector
Bronze Flange



CMPW
Specular Clear Reflector
Matte Powder White Flange



HW
Haze Reflector
White Flange



MPW
Matte Powder White Reflector
Matte Powder White Flange



HZMPW
Haze Reflector
White Flange



NN
Natural Metal Reflector
Natural Metal Flange



WW
White Reflector
White Flange

2" Iolite Square Adjustable Cone Reflector - Dedicated Housing Required

Reflector Type	Color Temp.	Finish	Lumens / Wattage
NI0B-2SC = Square Adjustable Cone	50X = 5000K*	BB = Black / Black	(blank) = 800lm / 14W
	CDX = Comfort Dim [†]	BW = Black / White	
	27X = 2700K	BZ = Bronze / Bronze	/10 = 1000lm / 14W /HL = 1500-2500lm (varies by housing)
	30X = 3000K	CMPW = Specular Clear / Matte Powder White	
	35X = 3500K	HW = Haze / White	
	40X = 4000K	HZMPW = Haze / Matte Powder White	
	50X = 5000K	MPW = Matte Powder White	
		NN = Natural Metal / Natural Metal	
		WW = White / White	

* 5000K LED modules in 800lm are while supplies last

[†] Comfort Dim available in 800lm only and 1" Iolite uses a different dimming curve than 2" & 4" Iolite

Compatible Housings

Housing Type
NHIOICD-28 = ICAT New Construction / 800-1000lm / 14W
NHIOICDCP-28 = Chicago Plenum / 800-1000lm / 14W
NHRIOIC-28 = ICAT Remodel / 800-1000lm / 14W
NHIOICD-215 = ICAT New Construction / 1500lm / 20W
NHIOICDCP-215 = Chicago Plenum / 1500lm / 20W
NHIOICD-220 = ICAT New Construction / 2000lm / 24W
NHIOICDCP-220 = Chicago Plenum / 2000lm / 24W
NHIOICD-225 = ICAT New Construction / 2500lm / 28W
NHIOICDCP-225 = Chicago Plenum / 2500lm / 28W

Example: **NI0B-2SC50XWW** = 2" Iolite Square Adjustable Cone Reflector, 5000K, White finish, 800lm / 14W

2" Iolite Accessories

2" Iolite Square Adjustable Cone Reflector

Type
Project
Catalog No.
Notes

FIELD CHANGEABLE OPTICS

Iolite reflectors include spot, narrow flood and flood optics. Optics can be changed in the field by removing LED module from die-cast reflector. Replacement optics include an optional frosted lens.

Note: Frosted filter-optics and Premium TIR optics are not compatible with /HL LED modules.

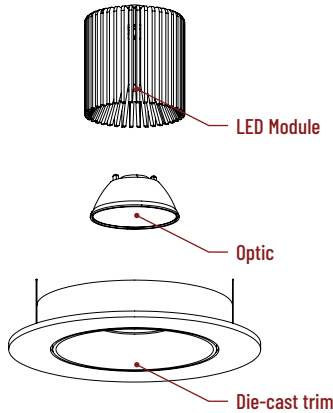

Frosted Filter-Optic

NIO-REFL38FR
NIO-REFL60FR

60° Optic
73° Optic

Not compatible with /HL LED module.



Premium TIR Optics

NIO-REFLTIR15
NIO-REFLTIR25

22° Optic
26° Optic

Not compatible with /HL or Comfort Dim (CDX) LED modules



10° TIR Optic Assembly

Specialized narrow spot LED module assembly is also available. Requires LE4 housing. [Click Here](#) for more information.

ACCESSORIES

Iolite accessories can be added at any point in the design process. Accessories easily install between LED module and die-cast reflector. Luminaire will accommodate (1) hex lower and (1) collar accessory, no accessory holder required.

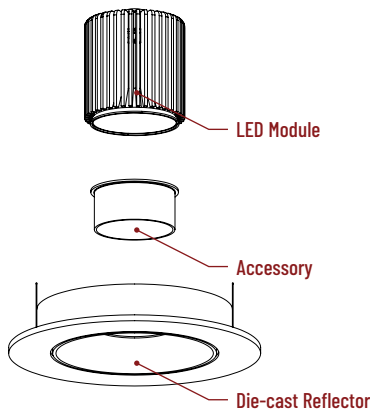

Translucent Decorative Collar

NIO-AS14(color) 5/8" length
NIO-AS19(color) 3/4" length
NIO-AS26(color) 1" length
Color:
AM (amber), BLU (blue), FR (frosted), R (red)

Translucent collars color the aperture with the specified color while producing white general light. Collars are available in different lengths. Use to add interest, create a theme, match a theme or define a space.



Opaque Collar Snoot

NIO-AS14(color) 5/8" length
NIO-AS19(color) 3/4" length
NIO-AS26(color) 1" length
Color:
BLK (black), MPW (matte powder white), WH (white)

Opaque snoot greatly reduces aperture brightness while preserving light output. (Note: Black snoot will reduce light)



Hex Cell Louver

NIO-HC Black
Hex cell louver subtly reduces aperture brightness by reducing light output by about 20%.

FLUSH MOUNT

2" Iolite reflectors can be installed flush with the drywall for a flush mount appearance. A flush mount mud ring is installed after the drywall and a professional drywall finisher floats the ceiling to blend in the mud ring.

Flush Mount Mud Ring



NIO-FMMR-2S Square Mud Ring

Mounts trim flush to ceiling with reflector flange visible. Mud ring attaches to drywall. **Only for use with NH10ICD-28 or NH10ICDCP-28 new construction housings and NIOB-2S reflectors.** Dimensions: 7-7/8" diameter 1/2" thick

PHOTOMETRICS

2" Iolite Square Adjustable Cone Reflector
800 lumens

Type

Project

Catalog No.

Notes

Test Information

Test Number: NTR11264
Part Number: NI0B-2SC30XWW
Beam Spread: 24° Spot
Lumens: 947lm
Wattage: 14.2W
Efficacy: 67lpw
CCT / CRI: 3000K / 90 CRI
Spacing Criteria (0°-180): 0.42
Spacing Criteria (90°-270): 0.42

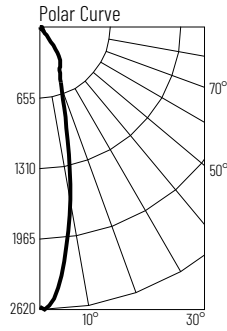

Illuminance at a Distance

Distance from Luminaire	FC at Nadir	Beam Diameter
4'	162fc	1'-8"
6'	72.1fc	2'-7"
8'	40.5fc	3'-6"
10'	25.9fc	4'-5"
12'	18fc	5'-2"

Zonal Lumen Summary

Zone	Lumens	% Luminaire
0-30	675	71.2
0-40	839	88.6
0-60	906	95.7
0-90	945	99.8
90-180	2	0.2
0-180	947	100

Candela Table

Vertical Angles	Candela
0	2594
5	2302
15	967
25	443
35	291
45	45

Test Information

Test Number: NTR11265
Part Number: NI0B-2SC30XWW
Beam Spread: 33° Narrow Flood
Lumens: 936lm
Wattage: 14.2W
Efficacy: 66lpw
CCT / CRI: 3000K / 90 CRI
Spacing Criteria (0°-180): 0.54
Spacing Criteria (90°-270): 0.54

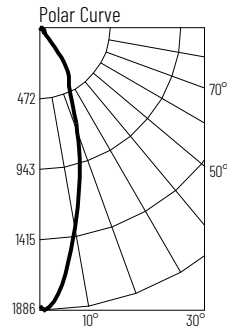

Illuminance at a Distance

Distance from Luminaire	FC at Nadir	Beam Diameter
4'	116fc	2'-5"
6'	51.6fc	3'-7"
8'	29fc	4'-10"
10'	18.6fc	5'-11"
12'	12.9fc	7'-1"

Zonal Lumen Summary

Zone	Lumens	% Luminaire
0-30	623	70.8
0-40	824	88.1
0-60	892	95.3
0-90	934	99.8
90-180	2	0.2
0-180	936	100

Candela Table

Vertical Angles	Candela
0	1858
5	1677
15	1021
25	480
35	279
45	45

Test Information

Test Number: NTR11263
Part Number: NI0B-2SC30XWW
Beam Spread: 44° Flood
Lumens: 962lm
Wattage: 14.2W
Efficacy: 68lpw
CCT / CRI: 3000K / 90 CRI
Spacing Criteria (0°-180): 0.64
Spacing Criteria (90°-270): 0.66

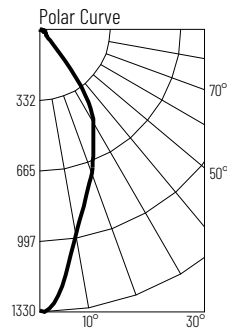

Illuminance at a Distance

Distance from Luminaire	FC at Nadir	Beam Diameter
4'	82.8fc	3'-4"
6'	36.8fc	4'-11"
8'	20.7fc	6'-6"
10'	13.2fc	8'-1"
12'	9.2fc	9'-10"

Zonal Lumen Summary

Zone	Lumens	% Luminaire
0-30	614	63.8
0-40	831	86.3
0-60	913	94.9
0-90	960	99.8
90-180	2	0.2
0-180	962	100

Candela Table

Vertical Angles	Candela
0	1324
5	1199
15	826
25	594
35	371
45	56

Lumen Output Multipliers

Color Temperature: 2700K (0.97), 3000K (1.00), 3500K (1.04), 4000K (1.16), 5000K (1.17)

PHOTOMETRICS

2" Iolite Square Adjustable Cone Reflector 1000 lumens

Type

Project

Catalog No.

Notes

Test Information

Test Number: NTR11264
Part Number: NI0B-2SC30XWW/10
Beam Spread: 28° Spot
Lumens: 1253lm
Wattage: 13.2W
Efficacy: 95lpw
CCT / CRI: 3000K / 90 CRI
Spacing Criteria (0°-180): 0.44
Spacing Criteria (90°-270): 0.15

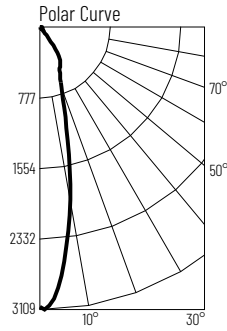

Illuminance at a Distance

Distance from Luminaire	FC at Nadir	Beam Diameter
4'	185fc	1'-11"
6'	82.3fc	2'-10"
8'	46.3fc	3'-8"
10'	29.6fc	4'-7"
12'	20.6fc	5'-7"

Zonal Lumen Summary

Zone	Lumens	% Luminaire
0-30	881	70.4
0-40	1089	87
0-60	1193	95.3
0-90	1248	99.7
90-180	4	0.3
0-180	1253	100

Candela Table

Vertical Angles	Candela
0	2964
5	2708
15	1198
25	558
35	367
45	60

Test Information

Test Number: NTR11272
Part Number: NI0B-2SC30XWW/10
Beam Spread: 36° Narrow Flood
Lumens: 1206lm
Wattage: 13W
Efficacy: 93lpw
CCT / CRI: 3000K / 90 CRI
Spacing Criteria (0°-180): 0.58
Spacing Criteria (90°-270): 0.16

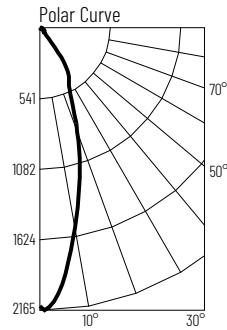

Illuminance at a Distance

Distance from Luminaire	FC at Nadir	Beam Diameter
4'	132fc	2'-7"
6'	58.9fc	3'-11"
8'	33.1fc	5'-2"
10'	21.2fc	6'-5"
12'	14.7fc	7'-8"

Zonal Lumen Summary

Zone	Lumens	% Luminaire
0-30	840	69.6
0-40	1044	86.5
0-60	1146	95
0-90	1203	99.8
90-180	3	0.2
0-180	1206	100

Candela Table

Vertical Angles	Candela
0	2119
5	1972
15	1264
25	605
35	357
45	57

Test Information

Test Number: NTR11274
Part Number: NI0B-2SC30XWW/10
Beam Spread: 47° Flood
Lumens: 1246lm
Wattage: 13.2W
Efficacy: 94lpw
CCT / CRI: 3000K / 90 CRI
Spacing Criteria (0°-180): 0.68
Spacing Criteria (90°-270): 0.18

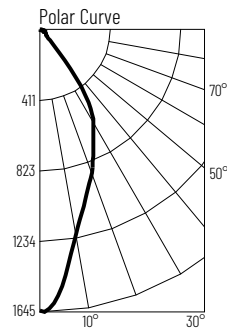

Illuminance at a Distance

Distance from Luminaire	FC at Nadir	Beam Diameter
4'	102fc	3'-6"
6'	45.4fc	5'-2"
8'	25.5fc	6'-11"
10'	16.4fc	8'-8"
12'	11.4fc	10'-5"

Zonal Lumen Summary

Zone	Lumens	% Luminaire
0-30	793	63.7
0-40	1071	86
0-60	1180	94.7
0-90	1243	99.8
90-180	3	0.2
0-180	1246	100

Candela Table

Vertical Angles	Candela
0	1635
5	1525
15	1070
25	768
35	474
45	74

Lumen Output Multipliers

Color Temperature: 2700K (0.98), 3000K (1.00), 3500K (1.09), 4000K (1.19), 5000K (1.16)

PHOTOMETRICS

2" Iolite Square Adjustable Cone Reflector 1500 lumens

Type

Project

Catalog No.

Notes

Test Information

Test Number: NTR1270
Part Number: NI0B-2SC40XWW/HL
Beam Spread: 39° Spot
Lumens: 1709lm
Wattage: 19.51W
Efficacy: 88lpw
CCT / CRI: 4000K / 90 CRI
Spacing Criteria (0°-180): 0.66
Spacing Criteria (90°-270): 0.66

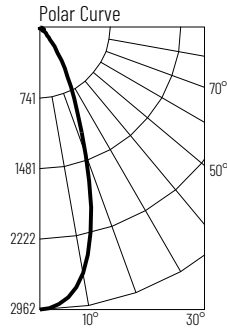

Illuminance at a Distance

Distance from Luminaire	FC at Nadir	Beam Diameter
6'	82.3fc	4'-4"
8'	46.3fc	5'-8"
10'	29.6fc	7'-1"
12'	20.6fc	8'-6"
14'	15.1fc	9'-11"

Zonal Lumen Summary

Zone	Lumens	% Luminaire
0-30	1255	73.4
0-40	1469	85.9
0-60	1638	95.8
0-90	1698	99.3
90-180	12	0.7
0-180	1709	100

Candela Table

Vertical Angles	Candela
0	2962
5	2880
15	2088
25	900
35	358
45	124

Test Information

Test Number: NTR1253
Part Number: NI0B-2SC40XWW/HL
Beam Spread: 49° Narrow Flood
Lumens: 1833lm
Wattage: 19.34W
Efficacy: 95lpw
CCT / CRI: 4000K / 90 CRI
Spacing Criteria (0°-180): 0.8
Spacing Criteria (90°-270): 0.8

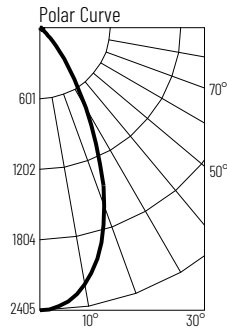

Illuminance at a Distance

Distance from Luminaire	FC at Nadir	Beam Diameter
6'	66.8fc	5'-7"
8'	37.6fc	7'-5"
10'	24fc	9'-4"
12'	16.7fc	11'-1"
14'	12.3fc	13'

Zonal Lumen Summary

Zone	Lumens	% Luminaire
0-30	1308	71.4
0-40	1617	88.2
0-60	1783	97.3
0-90	1824	99.5
90-180	9	0.5
0-180	1833	100

Candela Table

Vertical Angles	Candela
0	2405
5	2360
15	1966
25	1189
35	479
45	142

Test Information

Test Number: NTR1276
Part Number: NI0B-2SC40XWW/HL
Beam Spread: 61° Flood
Lumens: 1570lm
Wattage: 19.46W
Efficacy: 81lpw
CCT / CRI: 4000K / 90 CRI
Spacing Criteria (0°-180): 0.92
Spacing Criteria (90°-270): 0.92

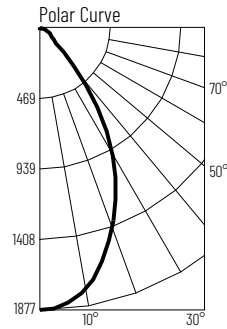

Illuminance at a Distance

Distance from Luminaire	FC at Nadir	Beam Diameter
6'	40.6fc	7'-1"
8'	22.8fc	9'-6"
10'	14.6fc	11'-11"
12'	10.1fc	14'-4"
14'	7.5fc	16'-8"

Zonal Lumen Summary

Zone	Lumens	% Luminaire
0-30	915	58.3
0-40	1231	78.4
0-60	1471	93.6
0-90	1560	99.3
90-180	11	0.7
0-180	1570	100

Candela Table

Vertical Angles	Candela
0	1460
5	1439
15	1251
25	938
35	551
45	175

Lumen Output Multipliers

Color Temperature: 2700K (0.83), 3000K (0.89), 3500K (1.00), 4000K (1.00), 5000K (1.06)

PHOTOMETRICS

2" Iolite Square Adjustable Cone Reflector 2000 lumens

Type

Project

Catalog No.

Notes

Test Information

Test Number: NTR1271
Part Number: NI0B-2SC40XWW/HL
Beam Spread: 39° Spot
Lumens: 1988lm
Wattage: 24.16W
Efficacy: 82lpw
CCT / CRI: 4000K / 90 CRI
Spacing Criteria (0°-180): 0.66
Spacing Criteria (90°-270): 0.66

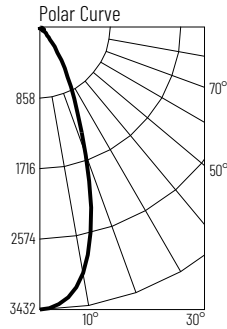

Illuminance at a Distance

Distance from Luminaire	FC at Nadir	Beam Diameter
6'	95.3fc	4'-4"
8'	53.6fc	5'-8"
10'	34.3fc	7'-1"
12'	23.8fc	8'-6"
14'	17.5fc	10'

Zonal Lumen Summary

Zone	Lumens	% Luminaire
0-30	1458	73.3
0-40	1724	86.7
0-60	1904	95.8
0-90	1974	99.3
90-180	14	0.7
0-180	1988	100

Candela Table

Vertical Angles	Candela
0	3432
5	3336
15	2418
25	1051
35	418
45	145

Test Information

Test Number: NTR1254
Part Number: NI0B-2SC40XWW/HL
Beam Spread: 49° Narrow Flood
Lumens: 2133lm
Wattage: 23.34W
Efficacy: 91lpw
CCT / CRI: 4000K / 90 CRI
Spacing Criteria (0°-180): 0.8
Spacing Criteria (90°-270): 0.8

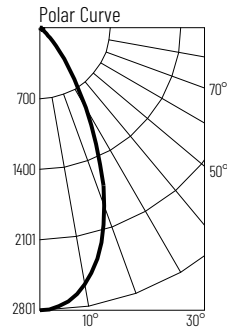

Illuminance at a Distance

Distance from Luminaire	FC at Nadir	Beam Diameter
6'	77.8fc	5'-7"
8'	43.8fc	7'-5"
10'	28fc	9'-4"
12'	19.5fc	11'-1"
14'	14.3fc	13'

Zonal Lumen Summary

Zone	Lumens	% Luminaire
0-30	1523	71.4
0-40	1883	88.2
0-60	2075	97.3
0-90	2123	99.5
90-180	10	0.5
0-180	2133	100

Candela Table

Vertical Angles	Candela
0	2801
5	2749
15	2290
25	1385
35	556
45	165

Test Information

Test Number: NTR1277
Part Number: NI0B-2SC40XWW/HL
Beam Spread: 61° Flood
Lumens: 1781lm
Wattage: 23.98W
Efficacy: 74lpw
CCT / CRI: 4000K / 90 CRI
Spacing Criteria (0°-180): 0.92
Spacing Criteria (90°-270): 0.92

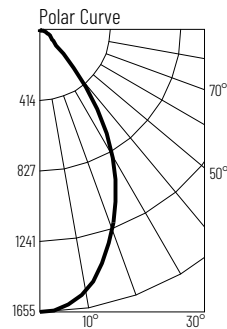

Illuminance at a Distance

Distance from Luminaire	FC at Nadir	Beam Diameter
6'	46fc	7'-1"
8'	25.9fc	9'-6"
10'	16.5fc	11'-11"
12'	11.5fc	14'-4"
14'	8.4fc	16'-8"

Zonal Lumen Summary

Zone	Lumens	% Luminaire
0-30	1037	58.2
0-40	1394	78.3
0-60	1667	93.6
0-90	1769	99.3
90-180	13	0.7
0-180	1781	100

Candela Table

Vertical Angles	Candela
0	1655
5	1631
15	1417
25	1063
35	624
45	197

Lumen Output Multipliers

Color Temperature: 2700K (0.84), 3000K (0.87), 3500K (0.99), 4000K (1.00), 5000K (1.07)

PHOTOMETRICS

2" Iolite Square Adjustable Cone Reflector 2500 lumens

Type

Project

Catalog No.

Notes

Test Information

Test Number: NTR1272
Part Number: NI0B-2SC40XWW/HL
Beam Spread: 39° Spot
Lumens: 2189lm
Wattage: 28.37W
Efficacy: 78lpw
CCT / CRI: 4000K / 90 CRI
Spacing Criteria (0°-180): 0.66
Spacing Criteria (90°-270): 0.66

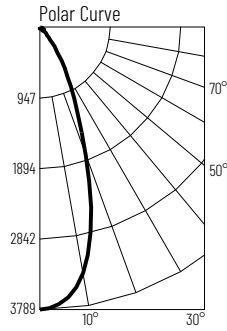

Illuminance at a Distance

Distance from Luminaire	FC at Nadir	Beam Diameter
6'	105fc	4'-4"
8'	59.2fc	5'-8"
10'	37.9fc	7'-1"
12'	26.3fc	8'-6"
14'	19.3fc	10'

Zonal Lumen Summary

Zone	Lumens	% Luminaire
0-30	1611	73.20
0-40	1906	86.6
0-60	2106	95.8
0-90	2184	99.3
90-180	16	0.7
0-180	2199	100

Candela Table

Vertical Angles	Candela
0	3789
5	3685
15	2671
25	1159
35	463
45	162

Test Information

Test Number: NTR1255
Part Number: NI0B-2SC40XWW/HL
Beam Spread: 49° Narrow Flood
Lumens: 2389lm
Wattage: 27.85W
Efficacy: 86lpw
CCT / CRI: 4000K / 90 CRI
Spacing Criteria (0°-180): 0.8
Spacing Criteria (90°-270): 0.8

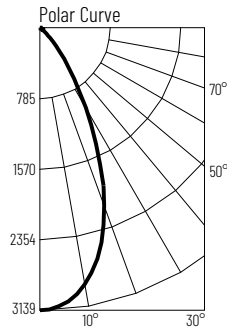

Illuminance at a Distance

Distance from Luminaire	FC at Nadir	Beam Diameter
6'	87.2fc	5'-7"
8'	49fc	7'-5"
10'	31.4fc	9'-4"
12'	21.8fc	11'-1"
14'	16fc	13'

Zonal Lumen Summary

Zone	Lumens	% Luminaire
0-30	1707	71.4
0-40	2109	88.3
0-60	2325	97.3
0-90	2378	99.5
90-180	11	0.5
0-180	2389	100

Candela Table

Vertical Angles	Candela
0	3139
5	3081
15	2565
25	1552
35	623
45	185

Test Information

Test Number: NTR1278
Part Number: NI0B-2SC40XWW/HL
Beam Spread: 61° Flood
Lumens: 2021lm
Wattage: 28.26W
Efficacy: 72lpw
CCT / CRI: 4000K / 90 CRI
Spacing Criteria (0°-180): 0.92
Spacing Criteria (90°-270): 0.92

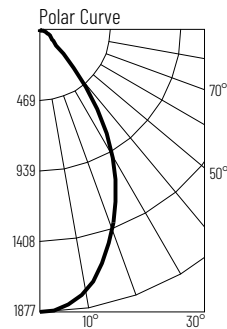

Illuminance at a Distance

Distance from Luminaire	FC at Nadir	Beam Diameter
6'	52.1fc	7'-1"
8'	29.3fc	9'-6"
10'	18.8fc	11'-11"
12'	13fc	14'-4"
14'	9.6fc	16'-8"

Zonal Lumen Summary

Zone	Lumens	% Luminaire
0-30	1176	58.2
0-40	1582	78.3
0-60	1891	93.6
0-90	2006	99.3
90-180	15	0.7
0-180	2021	100

Candela Table

Vertical Angles	Candela
0	1877
5	1849
15	1606
25	1205
35	708
45	224

Lumen Output Multipliers

Color Temperature: 2700K (0.82), 3000K (0.89), 3500K (0.99), 4000K (1.00), 5000K (1.05)