

NIOB-2SNDC

2" Iolite Square Reflector with Round Aperture

Source: 14W to 28W LED
800lm to 2500lm

Type

Project

Catalog No.

Notes

PRODUCT DESCRIPTION

2" Iolite downlights can be specified for use with Iolite new construction or remodel housings. Deep regressed cone reflectors optimize visual cut-off.

FEATURES

- 800lm, 1000lm, 1500lm, 2000lm or 2500lm LED packages
- 2700K, 3000K, 3500K, 4000K, 5000K @ 90+ CRI
- Comfort Dim (warm dimming) also available in 800lm only
- Flood optic, narrow flood and spot optics (included)
- 5-Year limited warranty

SPECIFICATION

Construction: Trims are constructed of heat dissipating, die-cast aluminum. The aluminum die-cast LED heat sink is threaded to fit the reflector and transfer heat.

Mounting: Luminaire includes friction blades to mount securely to housing.

OPTICS

800-1000lm: Three field changeable optics (spot, narrow flood and flood) are included with each LED module. Premium 10° TIR narrow spot optic assembly also available ([Click Here](#) for more information). Optional frosted and TIR optics are also available.

1500-2500lm: Three field changeable TIR optics (spot, narrow flood and flood) are included with each LED module.

ELECTRICAL

Lumens / Wattage: 800lm / 14W, 1000lm / 14W, 1500lm / 20W, 2000lm / 24W, 2500lm / 28W

Color Temperature: 2700K, 3000K, 3500K, 4000K, 5000K

Color Rendering Index: 90+ CRI

Operating Temperature: 0°C to 40°C

Lifetime: 50,000 hours @ L70

Comfort Dim: Comfort Dim color tunes the temperature from a bright 3100K, to a romantic and comfortable 2000K on a gradual, even curve. Available in 800lm only.

Dimming: Specified by housing

COMPATIBLE HOUSINGS

Luminaires are compatible with respective Iolite housings manufactured by Nora Lighting.

CATALOG NO.	DESCRIPTION	LUMENS / WATTAGE
NHIOICD-28	ICAT New Construction	800-1000lm / 14W
NHIOICDCP-28	Chicago Plenum	800-1000lm / 14W
NHRIOIC-28	ICAT Remodel	800-1000lm / 14W
NHIOICD-215	ICAT New Construction	1500lm / 20W
NHIOICDCP-215	Chicago Plenum	1500lm / 20W
NHIOICD-220	ICAT New Construction	2000lm / 24W
NHIOICDCP-220	Chicago Plenum	2000lm / 24W
NHIOICD-225	ICAT New Construction	2500lm / 28W
NHIOICDCP-225	Chicago Plenum	2500lm / 28W

Accessories: Luminaires can accommodate (1) hex louver and (1) translucent deco collar or opaque snoot, no accessory holder is required, see accessories page. Flush mount mud ring is available to give the appearance of a trimless, compatible with new construction housing only.

LABELS AND LISTINGS

- cULus Listed for Wet Locations
- ENERGY STAR certified
- [5-Year Limited Warranty](#)
- RoHS Compliant
- Certified to the high efficacy requirements of California Title 24 JA8-2019



PRODUCT IMAGES & DIMENSIONS

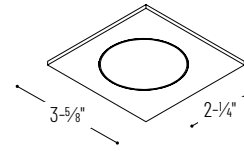

NIOB-2SNDC
Square Reflector with Round Aperture
Non-Adjustable

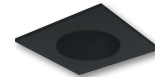

BB
Black Reflector
Black Flange

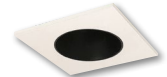

BW
Bronze Reflector
White Flange



BZ
Bronze Reflector
Bronze Flange

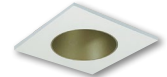

CHMPW
Champagne Haze Reflector
Matte Powder White Flange



CMPW
Specular Clear Reflector
Matte Powder White Flange

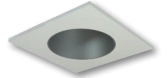

HW
Haze Reflector
White Flange

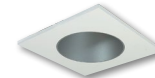

HZMPW
Haze Reflector
Matte Powder White Flange



MPW
Matte Powder White Reflector
Matte Powder White Flange



NN
Natural Metal Reflector
Natural Metal Flange

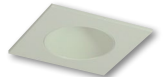

WW
White Reflector
White Flange

2" Iolite Square Reflector / Round Aperture - Dedicated Housing Required

Trim Type	Color Temp.	Finish	Lumens / Wattage
NIOB-2SNDC = Square Reflector with Round Aperture	50X = 5000K* CDX = Comfort Dim [†]	BB = Black / Black BW = Black / White BZ = Bronze / Bronze CHMPW = Champagne / Matte Powder White CMPW = Specular Clear / Matte Powder White HW = Haze / White HZMPW = Haze / Matte Powder White MPW = Matte Powder White NN = Natural Metal / Natural Metal WW = White / White	(blank) = 800lm / 14W /10 = 1000lm / 14W /HL = 1500-2500lm (varies by housing)
	27X = 2700K 30X = 3000K 35X = 3500K 40X = 4000K 50X = 5000K		

* 5000K LED modules in 800lm are while supplies last

† Comfort Dim available in 800lm only and 1" Iolite uses a different dimming curve than 2" & 4" Iolite

Compatible Housings

Housing Type
NHIOICD-28 = ICAT New Construction / 800-1000lm / 14W
NHIOICDCP-28 = Chicago Plenum / 800-1000lm / 14W
NHRIOIC-28 = ICAT Remodel / 800-1000lm / 14W
NHIOICD-215 = ICAT New Construction / 1500lm / 20W
NHIOICDCP-215 = Chicago Plenum / 1500lm / 20W
NHIOICD-220 = ICAT New Construction / 2000lm / 24W
NHIOICDCP-220 = Chicago Plenum / 2000lm / 24W
NHIOICD-225 = ICAT New Construction / 2500lm / 28W
NHIOICDCP-225 = Chicago Plenum / 2500lm / 28W

Example: **NIOB-2SNDC50XBB** = 2" Iolite Square Reflector / Round Aperture, 5000K, Black finish, 800lm / 14W

2" Iolite Accessories

2" Iolite Square Reflector with Round Aperture

Type

Project

Catalog No.

Notes

FIELD CHANGEABLE OPTICS

Iolite luminaires include spot, narrow flood and flood optics. Optics can be changed in the field by removing LED module from die-cast trim. Replacement optics include an optional frosted lens.

Note: Frosted filter-optics and Premium TIR optics are not compatible with /HL LED modules.

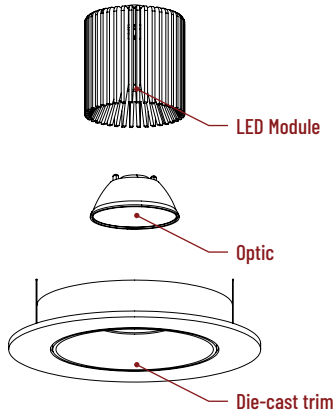

Frosted Filter-Optic

NIO-REFL38FR
NIO-REFL60FR

60° Optic
73° Optic

Not compatible with /HL LED module.



Premium TIR Optics

NIO-REFLTIR15
NIO-REFLTIR25

22° Optic
26° Optic

Not compatible with /HL or Comfort Dim (CDX) LED modules



10° TIR Optic Assembly

Specialized narrow spot LED module assembly is also available. Requires LE4 housing. [Click Here](#) for more information.

ACCESSORIES

Iolite accessories can be added at any point in the design process. Accessories easily install between LED module and die-cast trim.

Luminaire will accommodate (1) hex louver and (1) collar accessory, no accessory holder required.

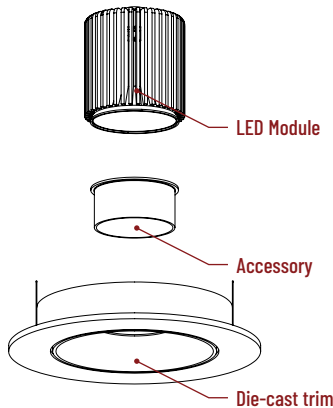

Translucent Decorative Collar

NIO-AS14(color) 5/8" length
NIO-AS19(color) 3/4" length
NIO-AS26(color) 1" length
Color:
AM (amber), **BLU** (blue), **FR** (frosted), **R** (red)

Translucent collars color the aperture with the specified color while producing white general light. Collars are available in different lengths. Use to add interest, create a theme, match a theme or define a space.



Opaque Collar Snoot

NIO-AS14(color) 5/8" length
NIO-AS19(color) 3/4" length
NIO-AS26(color) 1" length
Color:
BLK (black), **MPW** (matte powder white), **WH** (white)

Opaque snoot greatly reduces aperture brightness while preserving light output. (Note: Black snoot will reduce light)



Hex Cell Louver

NIO-HC Black
Hex cell louver subtly reduces aperture brightness by reducing light output by about 20%.

FLUSH MOUNT

2" Iolite trims can be installed flush with the drywall for a flush mount appearance. A flush mount mud ring is installed after the drywall and a professional drywall finisher floats the ceiling to blend in the mud ring.

Flush Mount Mud Ring

NIO-FMMR-2S Square Mud Ring

Mounts trim flush to ceiling with flange visible. **Mud ring attaches to drywall. Only for use with NH10ICD-28 or NH10ICDCP-28 new construction housings and NIOB-2S trims.**
Dimensions: 7-1/8" diameter 1/2" thick



PHOTOMETRICS

2" Iolite Square Reflector with Round Aperture
1000 lumens

Type

Project

Catalog No.

Notes

Test Information

Test Number: NTR11271R2
Part Number: NI0B-2RNDC30XWW/10
Beam Spread: 25° Spot
Lumens: 1105lm
Wattage: 13.78W
Efficacy: 80lpw
CCT / CRI: 3000K / 90 CRI
Spacing Criteria (0°-180°): 0.42
Spacing Criteria (90°-270°): 0.44

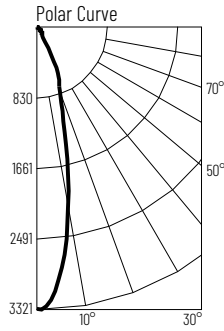

Illuminance at a Distance

Distance from Luminaire	FC at Nadir	Beam Diameter
4'	207fc	1'-10"
6'	9fc	2'-7"
8'	51.8fc	3'-6"
10'	33.1fc	4'-5"
12'	23fc	5'-4"

Zonal Lumen Summary

Zone	Lumens	% Luminaire
0-30	869	78.7
0-40	944	85.5
0-60	1055	95.5
0-90	1105	100
90-180	0	0
0-180	1105	100

Candela Table

Vertical Angles	Candela
0	3313
5	2927
15	1297
25	619
35	115
45	83

Test Information

Test Number: NTR11270R2
Part Number: NI0B-2RNDC30XWW/10
Beam Spread: 35° Narrow Flood
Lumens: 1088lm
Wattage: 13.8W
Efficacy: 79lpw
CCT / CRI: 3000K / 90 CRI
Spacing Criteria (0°-180°): 0.6
Spacing Criteria (90°-270°): 0.6

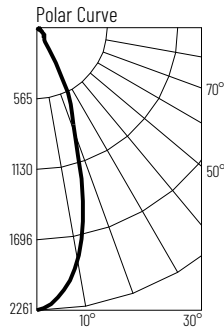

Illuminance at a Distance

Distance from Luminaire	FC at Nadir	Beam Diameter
4'	141fc	2'-6"
6'	62.8fc	3'-10"
8'	35.3fc	5'-1"
10'	22.6fc	6'-5"
12'	15.7fc	7'-7"

Zonal Lumen Summary

Zone	Lumens	% Luminaire
0-30	850	78.1
0-40	918	84.3
0-60	1036	95.2
0-90	1088	100
90-180	0	0
0-180	1088	100

Candela Table

Vertical Angles	Candela
0	3313
5	2927
15	1297
25	619
35	115
45	83

Test Information

Test Number: NTR11269R2
Part Number: NI0B-2RNDC30XWW/10
Beam Spread: 50° Flood
Lumens: 1068lm
Wattage: 13.84W
Efficacy: 77lpw
CCT / CRI: 3000K / 90 CRI
Spacing Criteria (0°-180°): 0.78
Spacing Criteria (90°-270°): 0.76

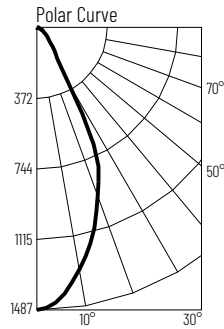

Illuminance at a Distance

Distance from Luminaire	FC at Nadir	Beam Diameter
4'	92.9fc	3'-8"
6'	41.3fc	5'-7"
8'	23.2fc	7'-6"
10'	14.9fc	9'-4"
12'	10.3fc	11'-2"

Zonal Lumen Summary

Zone	Lumens	% Luminaire
0-30	763	71.4
0-40	887	83
0-60	1011	94.7
0-90	1068	100
90-180	0	0
0-180	1068	100

Candela Table

Vertical Angles	Candela
0	1487
5	1430
15	1135
25	744
35	185
45	89

Lumen Output Multipliers

Color Temperature: 2700K (0.98), 3000K (1.00), 3500K (1.09), 4000K (1.19), 5000K (1.16)

PHOTOMETRICS

2" Iolite Square Reflector with Round Aperture 1500 lumens

Type

Project

Catalog No.

Notes

Test Information

Test Number: NTR1422
 Part Number: NI0B-2RNDC30XWW/HL
 Beam Spread: 38° Spot
 Lumens: 1667lm
 Wattage: 19.8W
 Efficacy: 84lpw
 CCT / CRI: 3000K / 90 CRI
 Spacing Criteria (0°-180): 0.64
 Spacing Criteria (90°-270): 0.64

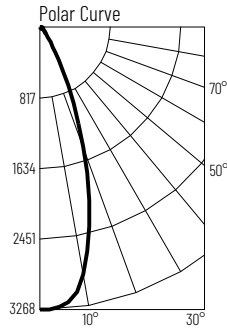

Illuminance at a Distance

Distance from Luminaire	FC at Nadir	Beam Diameter
6'	90.8fc	4'-1"
8'	51.1fc	5'-6"
10'	32.7fc	6'-11"
12'	22.7fc	8'-4"
14'	16.7fc	9'-7"

Zonal Lumen Summary

Zone	Lumens	% Luminaire
0-30	1315	78.9
0-40	1473	88.4
0-60	1600	96
0-90	1662	99.7
90-180	5	0.3
0-180	1667	100

Candela Table

Vertical Angles	Candela
0	3267
5	3216
15	2243
25	862
35	246
45	90

Test Information

Test Number: NTR1425
 Part Number: NI0B-2RNDC30XWW/HL
 Beam Spread: 48° Narrow Flood
 Lumens: 1843lm
 Wattage: 19.86W
 Efficacy: 93lpw
 CCT / CRI: 3000K / 90 CRI
 Spacing Criteria (0°-180): 0.78
 Spacing Criteria (90°-270): 0.8

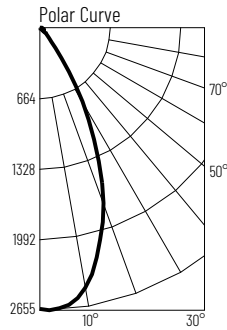

Illuminance at a Distance

Distance from Luminaire	FC at Nadir	Beam Diameter
6'	73.4fc	5'-5"
8'	41.3fc	7'-1"
10'	26.4fc	8'-11"
12'	18.3fc	10'-8"
14'	13.5fc	12'-6"

Zonal Lumen Summary

Zone	Lumens	% Luminaire
0-30	1401	76
0-40	1663	90.2
0-60	1783	96.8
0-90	1838	99.7
90-180	5	0.3
0-180	1843	100

Candela Table

Vertical Angles	Candela
0	2642
5	2600
15	2101
25	1236
35	401
45	93

Test Information

Test Number: NTR1428
 Part Number: NI0B-2RNDC30XWW/HL
 Beam Spread: 44° Flood
 Lumens: 1416lm
 Wattage: 19.65W
 Efficacy: 72lpw
 CCT / CRI: 3000K / 90 CRI
 Spacing Criteria (0°-180): 0.66
 Spacing Criteria (90°-270): 0.66

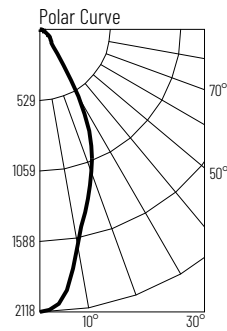

Illuminance at a Distance

Distance from Luminaire	FC at Nadir	Beam Diameter
6'	58.8fc	4'-10"
8'	33.1fc	6'-5"
10'	21.2fc	8'
12'	14.7fc	9'-7"
14'	10.8fc	11'-2"

Zonal Lumen Summary

Zone	Lumens	% Luminaire
0-30	971	68.6
0-40	1159	81.9
0-60	1329	93.8
0-90	1413	99.8
90-180	3	0.2
0-180	1416	100

Candela Table

Vertical Angles	Candela
0	2118
5	2012
15	1366
25	901
35	273
45	122

Lumen Output Multipliers

Color Temperature: 2700K (0.92), 3000K (1.00), 3500K (1.1), 4000K (1.12), 5000K (1.18)

PHOTOMETRICS

2" Iolite Square Reflector with Round Aperture 2000 lumens

Type

Project

Catalog No.

Notes

Test Information

Test Number: NTR1423
 Part Number: NI0B-2RNDC30XWW/HL
 Beam Spread: 38° Spot
 Lumens: 1892lm
 Wattage: 23.54W
 Efficacy: 80lpw
 CCT / CRI: 3000K / 90 CRI
 Spacing Criteria (0°-180): 0.64
 Spacing Criteria (90°-270): 0.64

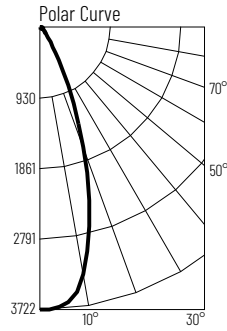

Illuminance at a Distance

Distance from Luminaire	FC at Nadir	Beam Diameter
8'	58.1fc	5'-6"
10'	37.2fc	6'-11"
12'	25.8fc	8'-4"
14'	19fc	9'-8"
16'	14.5fc	11'

Zonal Lumen Summary

Zone	Lumens	% Luminaire
0-30	1495	79
0-40	1663	87.9
0-60	1816	96
0-90	1886	99.7
90-180	6	0.3
0-180	1892	100

Candela Table

Vertical Angles	Candela
0	3718
5	3663
15	2562
25	973
35	276
45	101

Test Information

Test Number: NTR1426
 Part Number: NI0B-2RNDC30XWW/HL
 Beam Spread: 48° Narrow Flood
 Lumens: 2088lm
 Wattage: 23.6W
 Efficacy: 88lpw
 CCT / CRI: 3000K / 90 CRI
 Spacing Criteria (0°-180): 0.78
 Spacing Criteria (90°-270): 0.8

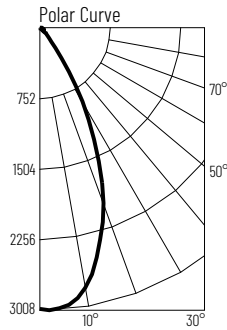

Illuminance at a Distance

Distance from Luminaire	FC at Nadir	Beam Diameter
8'	46.8fc	7'-1"
10'	29.9fc	8'-11"
12'	20.8fc	10'-8"
14'	15.3fc	12'-6"
16'	11.7fc	14'-4"

Zonal Lumen Summary

Zone	Lumens	% Luminaire
0-30	1588	76.1
0-40	1885	90.3
0-60	2020	96.8
0-90	2081	99.7
90-180	6	0.3
0-180	2088	100

Candela Table

Vertical Angles	Candela
0	2993
5	2948
15	2381
25	1402
35	453
45	105

Test Information

Test Number: NTR1429
 Part Number: NI0B-2RNDC30XWW/HL
 Beam Spread: 44° Flood
 Lumens: 1666lm
 Wattage: 23.53W
 Efficacy: 71lpw
 CCT / CRI: 3000K / 90 CRI
 Spacing Criteria (0°-180): 0.66
 Spacing Criteria (90°-270): 0.68

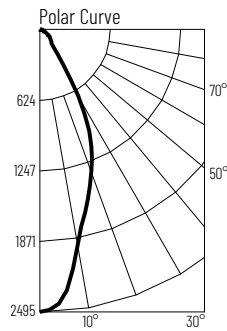

Illuminance at a Distance

Distance from Luminaire	FC at Nadir	Beam Diameter
8'	38.9fc	6'-5"
10'	24.9fc	8'
12'	17.3fc	9'-7"
14'	12.7fc	11'-2"
16'	9.7fc	12'-10"

Zonal Lumen Summary

Zone	Lumens	% Luminaire
0-30	1142	68.5
0-40	1349	81
0-60	1561	93.7
0-90	1661	99.7
90-180	5	0.3
0-180	1666	100

Candela Table

Vertical Angles	Candela
0	2492
5	2372
15	1606
25	1063
35	320
45	144

Lumen Output Multipliers

Color Temperature: 2700K (0.94), 3000K (1.00), 3500K (1.13), 4000K (1.13), 5000K (1.2)

PHOTOMETRICS

2" Iolite Square Reflector with Round Aperture 2500 lumens

Type

Project

Catalog No.

Notes

Test Information

Test Number: NTR1424
 Part Number: NI0B-2RNDC30XWW/HL
 Beam Spread: 38° Spot
 Lumens: 2142lm
 Wattage: 28.47W
 Efficacy: 75lpw
 CCT / CRI: 3000K / 90 CRI
 Spacing Criteria (0°-180): 0.64
 Spacing Criteria (90°-270): 0.64

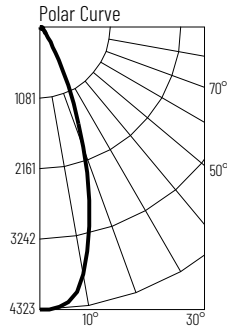

Illuminance at a Distance

Distance from Luminaire	FC at Nadir	Beam Diameter
10'	43.fc	6'-10"
12'	30fc	8'-2"
14'	22fc	8'-4"
16'	16.9fc	10'-11"
18'	13.3fc	12'-4"

Zonal Lumen Summary

Zone	Lumens	% Luminaire
0-30	1703	79.5
0-40	1886	88.1
0-60	2057	96
0-90	2134	99.6
90-180	8	0.4
0-180	2142	100

Candela Table

Vertical Angles	Candela
0	4318
5	4253
15	2944
25	1076
35	299
45	114

Test Information

Test Number: NTR1427
 Part Number: NI0B-2RNDC30XWW/HL
 Beam Spread: 48° Narrow Flood
 Lumens: 2359lm
 Wattage: 28.08W
 Efficacy: 84lpw
 CCT / CRI: 3000K / 90 CRI
 Spacing Criteria (0°-180): 0.78
 Spacing Criteria (90°-270): 0.8

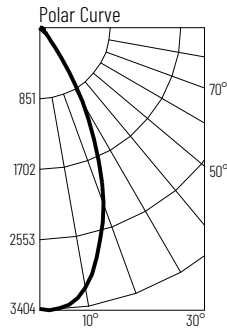

Illuminance at a Distance

Distance from Luminaire	FC at Nadir	Beam Diameter
10'	33.8fc	8'-11"
12'	23.5fc	10'-8"
14'	20.8fc	10'-8"
16'	13.2fc	14'-4"
18'	10.4fc	16'

Zonal Lumen Summary

Zone	Lumens	% Luminaire
0-30	1796	76.1
0-40	2130	90.3
0-60	2283	96.8
0-90	2352	99.7
90-180	7	0.3
0-180	2359	100

Candela Table

Vertical Angles	Candela
0	3385
5	3331
15	2691
25	1583
35	508
45	118

Test Information

Test Number: NTR1430
 Part Number: NI0B-2RNDC30XWW/HL
 Beam Spread: 44° Flood
 Lumens: 1950lm
 Wattage: 28.32W
 Efficacy: 69lpw
 CCT / CRI: 3000K / 90 CRI
 Spacing Criteria (0°-180): 0.66
 Spacing Criteria (90°-270): 0.68

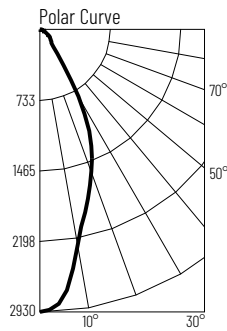

Illuminance at a Distance

Distance from Luminaire	FC at Nadir	Beam Diameter
10'	29.1fc	8'
12'	20.2fc	9'-7"
14'	17.3fc	9'-7"
16'	11.4fc	12'-10"
18'	9fc	14'-5"

Zonal Lumen Summary

Zone	Lumens	% Luminaire
0-30	1336	68.5
0-40	1579	80.9
0-60	1827	93.7
0-90	1945	99.7
90-180	6	0.3
0-180	1950	100

Candela Table

Vertical Angles	Candela
0	2910
5	2763
15	1878
25	1243
35	371
45	168

Lumen Output Multipliers

Color Temperature: 2700K (0.96), 3000K (1.00), 3500K (1.14), 4000K (1.16), 5000K (1.24)