

NIO-4SNDC

4" Iolite Square Reflector with Round Aperture

Source: 14W to 28W LED
800lm to 2500lm

Type

Project

Catalog No.

Notes

PRODUCT DESCRIPTION

4" Iolite LED downlights require a dedicated Iolite new construction or remodel housing. Deep regressed cone reflectors optimize visual cut-off.

FEATURES

- 800lm, 1000lm, 1500lm, 2000lm or 2500lm LED packages
- 2700K, 3000K, 3500K, 4000K, 5000K @ 90+ CRI
- Comfort Dim (warm dimming) also available in 800lm only
- Flood optic, narrow flood and spot optics (included)
- 5-Year limited warranty

SPECIFICATION

Construction: Trims are constructed of heat dissipating, die-cast aluminum. The aluminum die-cast LED heat sink is threaded to fit the trim and transfer heat.

Mounting: Luminaire includes friction blades to mount securely to housing.

OPTICS

800-1000lm: Three field changeable optics (spot, narrow flood and flood) are included with each LED module. Premium 10° TIR narrow spot optic assembly also available ([Click Here](#) for more information). Optional frosted and TIR optics are also available.

1500-2500lm: Three field changeable TIR optics (spot, narrow flood and flood) are included with each LED module.

ELECTRICAL

Lumens / Wattage: 800lm / 14W, 1000lm / 14W, 1500lm / 20W, 2000lm / 24W, 2500lm / 28W

Color Temperature: 2700K, 3000K, 3500K, 4000K, 5000K

Color Rendering Index: 90+CRI

Operating Temperature: Specified by housing

Lifetime: 50,000 hours @ L70

Comfort Dim: Comfort Dim color tunes the temperature from a bright 3100K, to a romantic and comfortable 2000K on a gradual, even curve. Available in 800lm only.

Dimming: Specified by housing

COMPATIBLE HOUSINGS

Luminaires are compatible with respective Iolite housings manufactured by Nora Lighting.

CATALOG NO.	DESCRIPTION	LUMENS / WATTAGE
NHIOICD-48	ICAT New Construction	800-1000lm / 14W
NHIOICDCP-48	Chicago Plenum	800-1000lm / 14W
NHRIOIC-48	ICAT Remodel	800-1000lm / 14W
NHIOICD-415	ICAT New Construction	1500lm / 20W
NHIOICDCP-415	Chicago Plenum	1500lm / 20W
NHIOICD-420	ICAT New Construction	2000lm / 24W
NHIOICDCP-420	Chicago Plenum	2000lm / 24W
NHIOICD-425	ICAT New Construction	2500lm / 28W
NHIOICDCP-425	Chicago Plenum	2500lm / 28W

Accessories: Luminaires can accommodate (1) hex louver and (1) translucent deco collar or opaque snoot, no accessory holder is required, see accessories page. Flush mount mud ring is available to give the appearance of a trimless, compatible with new construction housing only.

LABELS AND LISTINGS

- cULus Listed for Wet Locations
- ENERGY STAR certified
- [5-Year Limited Warranty](#)
- RoHS Compliant
- Certified to the high efficacy requirements of California Title 24 JA8-2019



PRODUCT IMAGES & DIMENSIONS

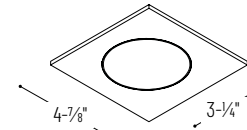

NIO-4SNDC
Square Reflector with Round Aperture
Non-Adjustable

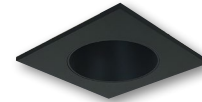

BB
Black Reflector
Black Flange

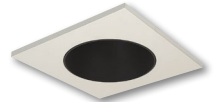

BW
Black Reflector
White Flange



BZ
Bronze Reflector
Bronze Flange



CHMPW
Champagne Haze Reflector
Matte Powder White Flange

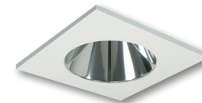

CMPW
Specular Clear Reflector
Matte Powder White Flange



HW
Haze Reflector
White Flange



HZMPW
Haze Reflector
Matte Powder White Flange



MPW
Matte Powder White Reflector
Matte Powder White Flange



NN
Natural Metal Reflector
Natural Metal Flange



WW
White Reflector
White Flange

4" Iolite Square Reflector with Round Aperture - Dedicated Housing Required

Reflector Type	Color Temp.	Finish	Lumens / Wattage
NIO-4SNDC = Square Reflector with Round Aperture	50X = 5000K* CDX = Comfort Dim [†]	BB = Black / Black BW = Black / White BZ = Bronze / Bronze CHMPW = Champagne / Matte Powder White CMPW = Specular Clear / Matte Powder White HW = Haze / White HZMPW = Haze / Matte Powder White MPW = Matte Powder White NN = Natural Metal / Natural Metal WW = White / White	(blank) = 800lm / 14W /10 = 1000lm / 14W /HL = 1500-2500lm (varies by housing)

* 5000K LED modules in 800lm are while supplies last

[†] Comfort Dim available in 800lm only and 1" Iolite uses a different dimming curve than 2" & 4" Iolite

Compatible Housings

Housing Type
NHIOICD-48 = ICAT New Construction / 800-1000lm / 14W
NHIOICDCP-48 = Chicago Plenum / 800-1000lm / 14W
NHRIOIC-48 = ICAT Remodel / 800-1000lm / 14W
NHIOICD-415 = ICAT New Construction / 1500lm / 20W
NHIOICDCP-415 = Chicago Plenum / 1500lm / 20W
NHIOICD-420 = ICAT New Construction / 2000lm / 24W
NHIOICDCP-420 = Chicago Plenum / 2000lm / 24W
NHIOICD-425 = ICAT New Construction / 2500lm / 28W
NHIOICDCP-425 = Chicago Plenum / 2500lm / 28W

Example: **NIO-4SNDC50XWW** = 4" Iolite Square Reflector with Round Aperture, 5000K, White finish, 800lm / 14W

4" Iolite Accessories

4" Iolite Square Reflector with Round Aperture

Type
Project
Catalog No.
Notes

FIELD CHANGEABLE OPTICS

Iolite luminaires include spot, narrow flood and flood optics. Optics can be changed in the field by removing LED module from die-cast trim. Optional frosted and TIR optics are also available.

Note: Frosted and Premium TIR optics are not compatible with /HL LED modules.

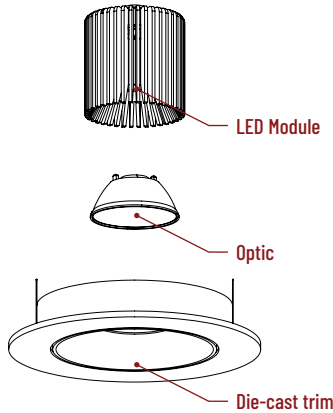

Frosted Filter-Optic

NIO-REFL38FR
NIO-REFL60FR

60° Optic
73° Optic

Not compatible with /HL LED module.



Premium TIR Optics

NIO-REFLTIR15
NIO-REFLTIR25

22° Optic
26° Optic

Not compatible with /HL or Comfort Dim (CDX) LED modules



10° TIR Optic Assembly

Specialized narrow spot LED module assembly is also available. Requires LE4 housing. [Click Here](#) for more information.

ACCESSORIES

Iolite accessories can be added at any point in the design process. Accessories easily install between LED module and die-cast trim.

Luminaire will accommodate (1) hex louver and (1) collar accessory, no accessory holder required.

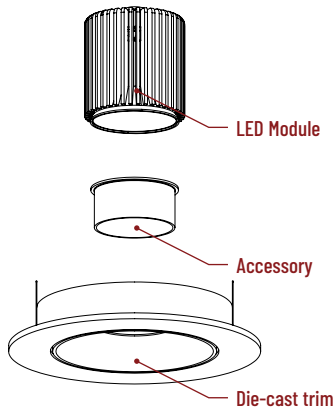

Translucent Decorative Collar

NIO-AS14(color) 5/8" length
NIO-AS19(color) 3/4" length
NIO-AS26(color) 1" length
Color:
AM (amber), **BLU** (blue), **FR** (frosted), **R** (red)

Translucent collars color the aperture with the specified color while producing white general light. Collars are available in different lengths. Use to add interest, create a theme, match a theme or define a space.



Opaque Collar Snoot

NIO-AS14(color) 5/8" length
NIO-AS19(color) 3/4" length
NIO-AS26(color) 1" length
Color:
BLK (black), **MPW** (matte powder white), **WH** (white)

Opaque snoot greatly reduces aperture brightness while preserving light output. (Note: Black snoot will reduce light)



Hex Cell Louver

NIO-HC Black
Hex cell louver subtly reduces aperture brightness by reducing light output by about 20%.

FLUSH MOUNT

4" Iolite trims can be installed flush with the drywall for a flush mount appearance. A flush mount mud ring is installed after the drywall and a professional drywall finisher floats the ceiling to blend in the mud ring.

Flush Mount Mud Ring



NIO-FMMR-4S Square Mud Ring

Mounts trim flush to ceiling with flange visible. Mud ring attaches to drywall. **Only for use with NH10ICD-48 or NH10ICDCP-48 new construction housings and NIO-4S reflectors.**
Dimensions: 7-7/8" diameter 1/2" thick

PHOTOMETRICS

4" Iolite Square Reflector with Round Aperture
1000 lumens

Type

Project

Catalog No.

Notes

Test Information

Test Number: NTR11291
Part Number: N10-4SNDC30XBW/10
Beam Spread: 27° Spot
Lumens: 1089lm
Wattage: 13.53W
Efficacy: 81lpw
CCT / CRI: 3000K / 90 CRI
Spacing Criteria (0°-180): 0.46
Spacing Criteria (90°-270): 0.48

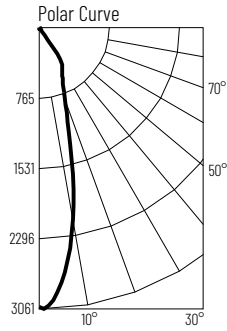

Illuminance at a Distance

Distance from Luminaire	FC at Nadir	Beam Diameter
4'	189fc	1'-11"
6'	84.1fc	2'-11"
8'	47.3fc	3'-11"
10'	30.3fc	4'-10"
12'	21fc	5'-10"

Zonal Lumen Summary

Zone	Lumens	% Luminaire
0-30	884	81.1
0-40	1062	97.5
0-60	1085	99.6
0-90	1085	99.6
90-180	4	0.4
0-180	1089	100

Candela Table

Vertical Angles	Candela
0	3027
5	2721
15	1292
25	586
35	329
45	24

Test Information

Test Number: NTR11230
Part Number: N10-4SNDC30XBW/10
Beam Spread: 41° Narrow Flood
Lumens: 1059lm
Wattage: 13.42W
Efficacy: 79lpw
CCT / CRI: 3000K / 90 CRI
Spacing Criteria (0°-180): 0.66
Spacing Criteria (90°-270): 0.66

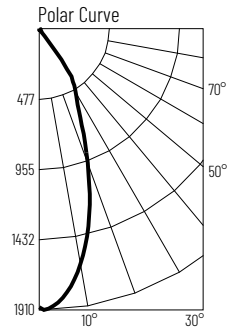

Illuminance at a Distance

Distance from Luminaire	FC at Nadir	Beam Diameter
4'	118fc	3'
6'	52.6fc	4'-6"
8'	29.6fc	5'-11"
10'	18.9fc	7'-5"
12'	13.1fc	8'-11"

Zonal Lumen Summary

Zone	Lumens	% Luminaire
0-30	851	80.4
0-40	1028	97
0-60	1055	99.6
0-90	1055	99.7
90-180	4	0.3
0-180	1059	100

Candela Table

Vertical Angles	Candela
0	1893
5	1805
15	1305
25	681
35	279
45	19

Test Information

Test Number: NTR11232
Part Number: N10-4SNDC30XBW/10
Beam Spread: 60° Flood
Lumens: 1042lm
Wattage: 13.5W
Efficacy: 77lpw
CCT / CRI: 3000K / 90 CRI
Spacing Criteria (0°-180): 0.9
Spacing Criteria (90°-270): 0.88

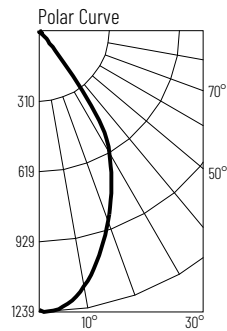

Illuminance at a Distance

Distance from Luminaire	FC at Nadir	Beam Diameter
4'	76.6fc	4'-6"
6'	34fc	6'-8"
8'	19.1fc	9'
10'	12.2fc	11'-2"
12'	8.5fc	13'-6"

Zonal Lumen Summary

Zone	Lumens	% Luminaire
0-30	744	71.4
0-40	979	94
0-60	1037	99.6
0-90	1038	99.7
90-180	4	0.3
0-180	1042	100

Candela Table

Vertical Angles	Candela
0	1225
5	1194
15	1024
25	767
35	367
45	57

Lumen Output Multipliers

Color Temperature: 2700K (0.98), 3000K (1.00), 3500K (1.09), 4000K (1.19), 5000K (1.16)

PHOTOMETRICS

4" Iolite Square Reflector with Round Aperture 1500 lumens

Type

Project

Catalog No.

Notes

Test Information

Test Number: NTR1659R1
Part Number: N10-4SNDC30XWW/HL
Beam Spread: 42° Spot
Lumens: 1744lm
Wattage: 19.4W
Efficacy: 90lpw
CCT / CRI: 3000K / 90 CRI
Spacing Criteria (0°-180°): 0.7
Spacing Criteria (90°-270°): 0.7

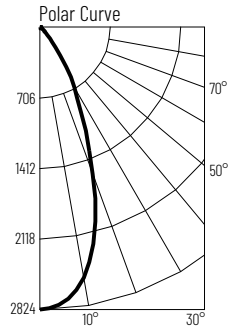

Illuminance at a Distance

Distance from Luminaire	FC at Nadir	Beam Diameter
6'	78.4fc	4'-8"
8'	44.1fc	6'-4"
10'	28.2fc	7'-10"
12'	19.6fc	9'-5"
14'	14.4fc	10'-11"

Zonal Lumen Summary

Zone	Lumens	% Luminaire
0-30	1318	75.5
0-40	1574	90.3
0-60	1698	97.3
0-90	1733	99.4
90-180	11	0.6
0-180	1744	100

Candela Table

Vertical Angles	Candela
0	2824
5	2755
15	2126
25	1043
35	417
45	100

Test Information

Test Number: NTR1661R1
Part Number: N10-4SNDC30XWW/HL
Beam Spread: 54° Narrow Flood
Lumens: 1915lm
Wattage: 19.4W
Efficacy: 99lpw
CCT / CRI: 3000K / 90 CRI
Spacing Criteria (0°-180°): 0.88
Spacing Criteria (90°-270°): 0.86

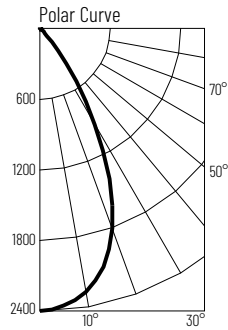

Illuminance at a Distance

Distance from Luminaire	FC at Nadir	Beam Diameter
6'	66.7fc	6'-1"
8'	37.5fc	8'-2"
10'	24fc	10'-2"
12'	16.7fc	12'-4"
14'	12.2fc	14'-4"

Zonal Lumen Summary

Zone	Lumens	% Luminaire
0-30	1422	74.3
0-40	1765	92.1
0-60	1879	98.1
0-90	1903	99.4
90-180	12	0.6
0-180	1915	100

Candela Table

Vertical Angles	Candela
0	2400
5	2365
15	2095
25	1408
35	547
45	86

Test Information

Test Number: NTR1663R1
Part Number: N10-4SNDC30XWW/HL
Beam Spread: 66° Flood
Lumens: 1591lm
Wattage: 19.26W
Efficacy: 83lpw
CCT / CRI: 3000K / 90 CRI
Spacing Criteria (0°-180°): 1.02
Spacing Criteria (90°-270°): 1.02

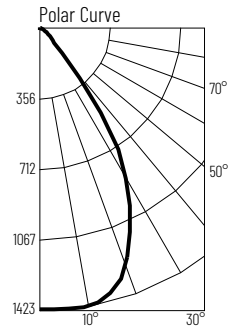

Illuminance at a Distance

Distance from Luminaire	FC at Nadir	Beam Diameter
6'	39.4fc	7'-10"
8'	22.1fc	10'-6"
10'	14.2fc	13'-1"
12'	9.8fc	15'-8"
14'	7.2fc	18'-4"

Zonal Lumen Summary

Zone	Lumens	% Luminaire
0-30	1016	63.9
0-40	1354	85.1
0-60	1533	96.4
0-90	1582	99.5
90-180	9	0.6
0-180	1591	100

Candela Table

Vertical Angles	Candela
0	1417
5	1420
15	1383
25	1083
35	594
45	104

Lumen Output Multipliers

Color Temperature: 2700K (0.92), 3000K (1.00), 3500K (1.1), 4000K (1.12), 5000K (1.18)

PHOTOMETRICS

4" Iolite Square Reflector with Round Aperture 2000 lumens

Type

Project

Catalog No.

Notes

Test Information

Test Number: NTR1660R1
Part Number: NI0-4SNDC30XWW/HL
Beam Spread: 43° Spot
Lumens: 2047lm
Wattage: 23.38W
Efficacy: 88lpw
CCT / CRI: 3000K / 90 CRI
Spacing Criteria (0°-180°): 0.7
Spacing Criteria (90°-270°): 0.7

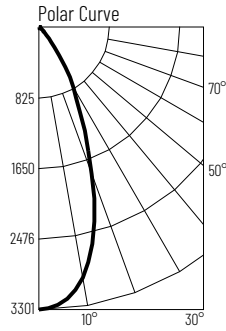

Illuminance at a Distance

Distance from Luminaire	FC at Nadir	Beam Diameter
12'	22.9fc	9'-5"
14'	16.8fc	11'
16'	12.9fc	12'-7"
18'	10.2fc	14'-1"
20'	8.3fc	15'-8"

Zonal Lumen Summary

Zone	Lumens	% Luminaire
0-30	1545	75.5
0-40	1847	90.3
0-60	1992	97.3
0-90	2034	99.4
90-180	13	0.6
0-180	2047	100

Candela Table

Vertical Angles	Candela
0	3301
5	3208
15	2461
25	1248
35	481
45	117

Test Information

Test Number: NTR1662R1
Part Number: NI0-4SNDC30XWW/HL
Beam Spread: 54° Narrow Flood
Lumens: 2249lm
Wattage: 23.4W
Efficacy: 96lpw
CCT / CRI: 3000K / 90 CRI
Spacing Criteria (0°-180°): 0.88
Spacing Criteria (90°-270°): 0.86

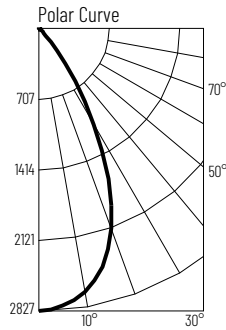

Illuminance at a Distance

Distance from Luminaire	FC at Nadir	Beam Diameter
12'	19.6fc	12'-4"
14'	14.4fc	14'-4"
16'	11fc	16'-4"
18'	8.7fc	18'-5"
20'	7.1fc	20'-5"

Zonal Lumen Summary

Zone	Lumens	% Luminaire
0-30	1671	74.3
0-40	2072	92.1
0-60	2206	98.1
0-90	2234	99.4
90-180	15	0.6
0-180	2249	100

Candela Table

Vertical Angles	Candela
0	2827
5	2783
15	2473
25	1652
35	628
45	107

Test Information

Test Number: NTR1664R1
Part Number: NI0-4SNDC30XWW/HL
Beam Spread: 66° Flood
Lumens: 1878lm
Wattage: 23.43W
Efficacy: 80lpw
CCT / CRI: 3000K / 90 CRI
Spacing Criteria (0°-180°): 1.02
Spacing Criteria (90°-270°): 1.02

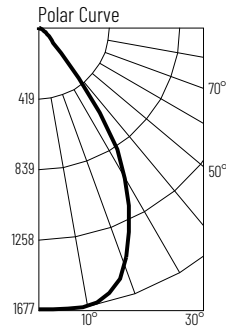

Illuminance at a Distance

Distance from Luminaire	FC at Nadir	Beam Diameter
12'	11.6fc	15'-8"
14'	8.5fc	18'-4"
16'	6.5fc	20'-11"
18'	5.2fc	23'-6"
20'	4.2fc	26'-1"

Zonal Lumen Summary

Zone	Lumens	% Luminaire
0-30	1199	63.9
0-40	1598	85.1
0-60	1808	96.4
0-90	1867	99.5
90-180	11	0.6
0-180	1878	100

Candela Table

Vertical Angles	Candela
0	1672
5	1675
15	1628
25	1278
35	700
45	121

Lumen Output Multipliers

Color Temperature: 2700K (0.94), 3000K (1.00), 3500K (1.13), 4000K (1.13), 5000K (1.2)