

PAVO Outdoor
3-753-15

oxygen

FIXTURE TYPE _____

LOCATION _____

PROJECT _____

DATE _____



-15 Black

LIGHT SOURCE	(1x) 8W LED with Driver on board, 3000K, CRI 90
LUMINAIRE POWER	8.3W Input Power
RATED LIFE	30000 hr RL
OPTIONAL COLOR TEMPERATURES	3000K Only
LUMEN OUTPUT	Delivered: 290 lm (LM-79)
INPUT VOLTAGE	120V AC, 50/60Hz
DIMMING	TRIAC Dimming
CONSTRUCTION	Cast Aluminum Housing
DIFFUSER	- Clear Pinstripe Glass
FINISHES	Black (-15)
MOUNTING	4" Octagonal J-Box (Installer must provide a bead of caulk between fixture housing and mounting surface)
STANDARDS	ETL Wet listed, ADA Compliant, Conforms to UL STD 1598, Certified CAN/CSA STD C22.2 No 250.0.

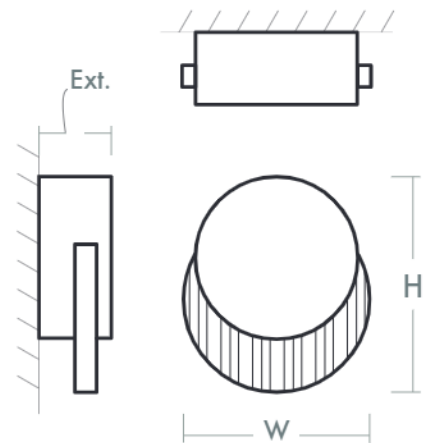

DIMENSIONS

W:	5.50"
H:	6.25"
Ext:	2.125"
M.C:	2.375" From top of fixture

Order example for standard fixture:
3-753-15 (x- Voltage - xxx-Sequence # - xx-Finish)
3: 120V Only

