



OLO  $\Phi$  fuses the diameter symbol  $\Phi$  into basic shapes of circles and lines. With an omnidirectional light rotation capability, the shade of the wall/ceiling lamp can be tilted vertically as well as horizontally, and for the pendant lamp, it can be rotated vertically. With a Saturn ring-like appearance, the supportive U-bend frame and round frame are exquisitely finished in Matt Black. Mood-inducing lighting always creates for instant ambiances.

By Li, Hui Lun 李慧倫





shiny black



champagne gold

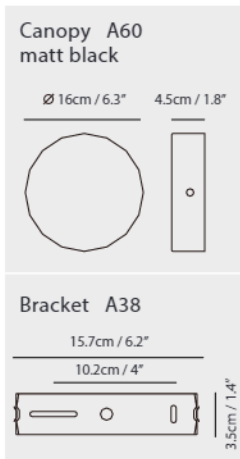
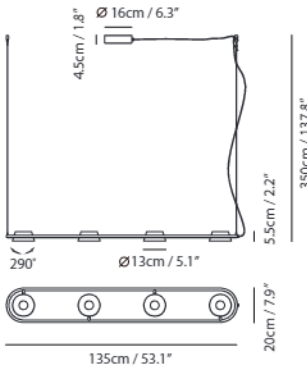

**OLO Ø Pendant PL4**

**Model**  
SLD-130PL4

**Material**  
metal, aluminum, PP

**Light Source**  
LED 4 x 6.5W 3000K  
CRI90 1650lm

**Driver**  
Built-in dimmable driver  
(Triac dimming)

**Weight**  
2.9kg / 6.4lb

- Color**
- matt black + shiny black shade
  - matt black + champagne gold shade

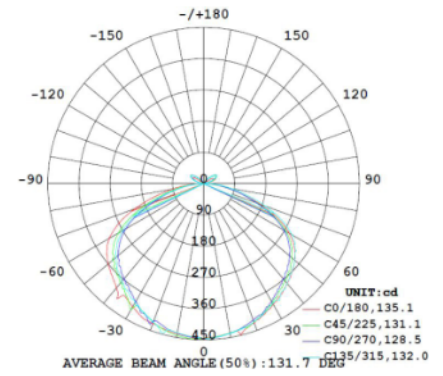





matt black +  
champagne gold shade

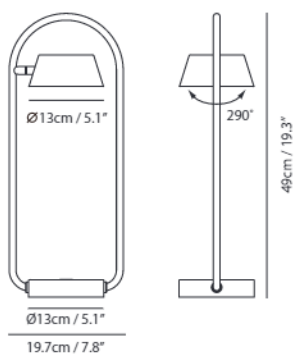

#### OLO Φ Table

**Model**  
SLD-130DTE

**Material**  
metal, aluminum, PP

**Light Source**  
LED 6.5W 3000K CRI90 415lm

**Feature**  
Touch dimmer switch

**Weight**  
1.4kg / 3.1lb

**Cord**  
200cm / 78.7"

**Color**  
 matt black + champagne gold shade





matt black + champagne gold shade    matt black + shiny black shade

Measurement : centimeter / inches

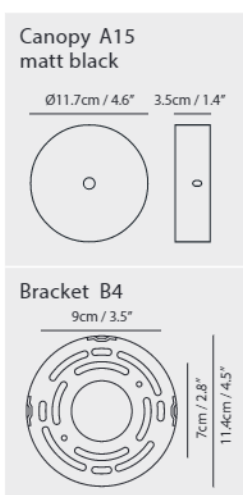
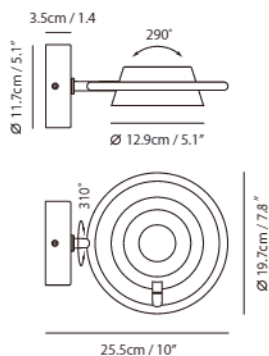

**OLO Φ Wall / Ceiling**

**Model**  
SLD-130CW

**Material**  
steel, PP

**Light Source**  
LED 6.5W 3000K CRI 90 415lm

**Driver**  
Built-in dimmable driver (triac dimming)

**Weight**  
0.8kg / 1.8lb

**Color**  
 matt black + champagne gold shade  
 matt black + shiny black shade