



SIRCLE, a symbolization merged Square and Circle, inspired by the East aesthetic philosophy, the circular light ball just like a soft tender mind leans on the rigid prudent frame, chemically shaped a harmonious feature with its flexible body inside-out. Meanwhile, the fantastic performance of light through the opal mouth-blown glass, spreading the beauty of moonlight all over the space.

By Li, Hui Lun 李慧倫





champagne gold



matt black

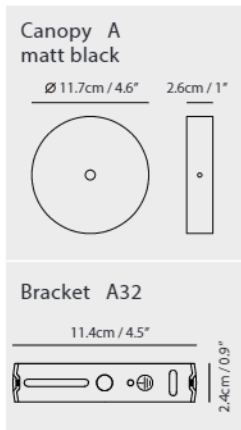
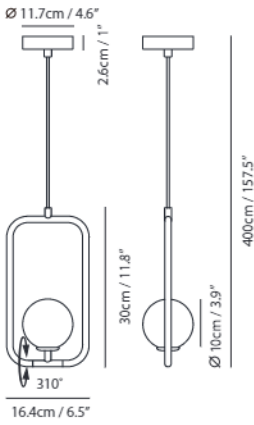

**Sircle Pendant S**

**Model**  
SG-100PV

**Material**  
mouth-blown glass, steel

**Light Source**  
G9 1 x 3W LED 2700K CRI90

**Weight**  
0.8kg / 1.8lb

**Color**  

 matt opal + champagne gold  
 matt opal + matt black

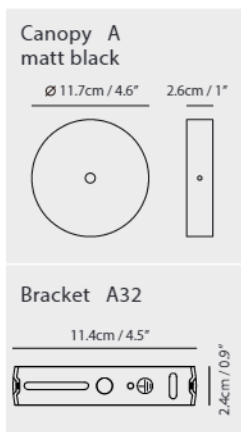
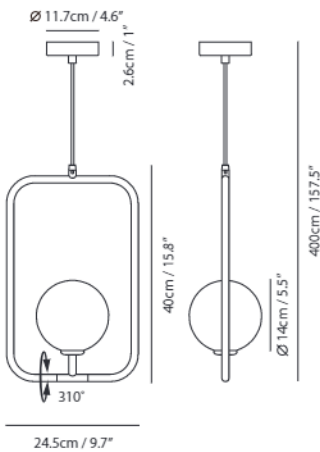

**Sircle Pendant L**

**Model**  
SG-140PV

**Material**  
mouth-blown glass, steel

**Light Source**  
G9 1 x 5W LED 2700K CRI90

**Weight**  
1.6kg / 3.5lb

**Color**  

 matt opal + champagne gold  
 matt opal + matt black





champagne gold

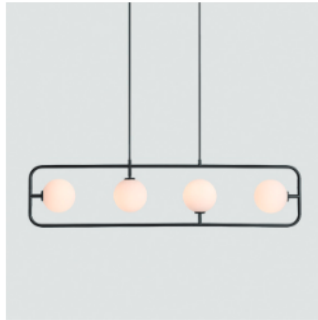

matt black



copper

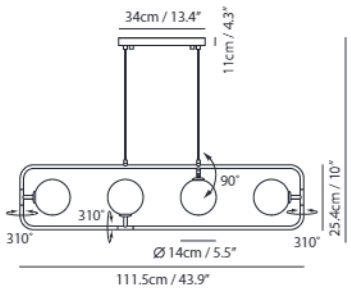

**Canopy C16**  
matt black

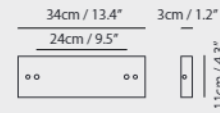

**Bracket A31**

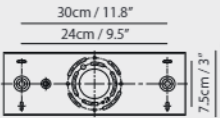



**Sircle Pendant PH4**

**Model**  
SG-140PH4

**Material**  
mouth-blown glass, steel

**Light Source**  
G9 4 x 5W LED 2700K CRI90

**Weight**  
5.0kg / 11lb

- Color**
-  matt opal + champagne gold
  -  matt opal + matt black
  -  matt opal + copper





champagne gold

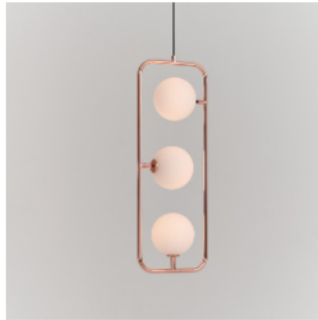

copper

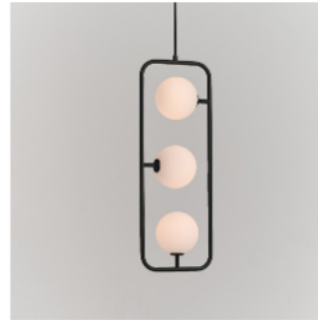

matt black

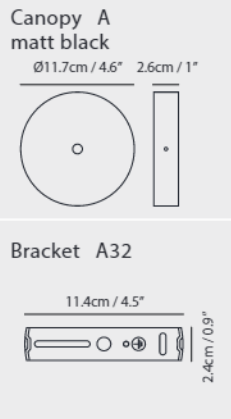
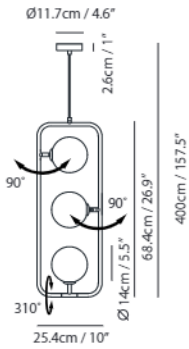

**Sircle Pendant PV3**

**Model**  
SG-140PV3

**Material**  
mouth-blown glass, steel

**Light Source**  
G9 3 x 5W LED 2700K CRI90

**Weight**  
2.3kg / 5.1lb

- Color**
-  matt opal + champagne gold
  -  matt opal + copper
  -  matt opal + matt black





champagne gold

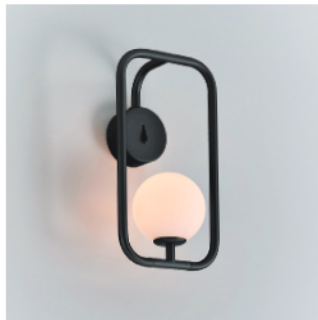

matt black

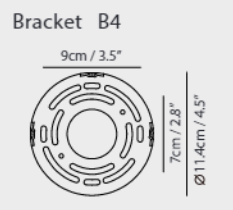
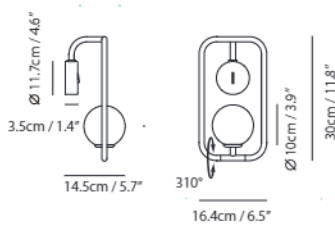

**Sircle Wall**



**Model**  
SG-100WV

**Material**  
mouth-blown glass, steel

**Light Source**  
G9 1 x 3W LED 2700K CRI90

**Weight**  
1.1kg / 2.4lb

**Color**

-  matt opal + champagne gold
-  matt opal + matt black

\* Fixture can be installed horizontally, or vertically, in both directions, offering a high degree of flexibility.