



OLO  $\Phi$  fuses the diameter symbol  $\Phi$  into basic shapes of circles and lines. With an omnidirectional light rotation capability, the shade of the wall/ceiling lamp can be tilted vertically as well as horizontally, and for the pendant lamp, it can be rotated vertically. With a Saturn ring-like appearance, the supportive U-bend frame and round frame are exquisitely finished in Matt Black. Mood-inducing lighting always creates for instant ambiances.

By Li, Hui Lun 李慧倫





shiny black



champagne gold

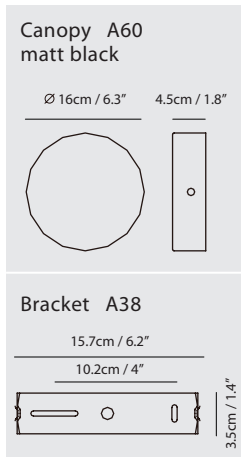
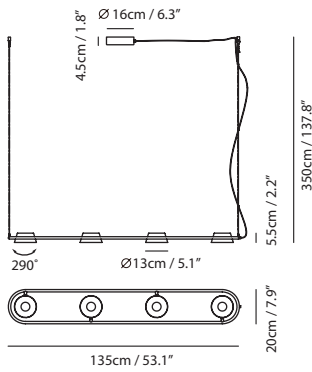

**OLO  $\Phi$  Pendant PL4**

**Model**  
SLD-130PL4



**Material**  
steel, PP

**Light Source**  
LED 4 x 6.5W 3000K  
CRI90 1650lm

**Driver**  
Built-in dimmable driver  
(Triac dimming)

**Weight**  
2.9kg / 6.4lb

**Color**

-  shiny black shade + matt black
-  champagne gold shade + matt black

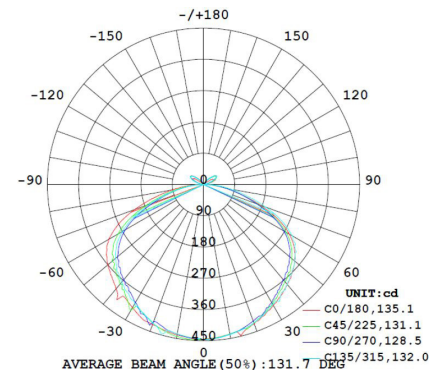





shiny black



champagne gold



pearl cocoa

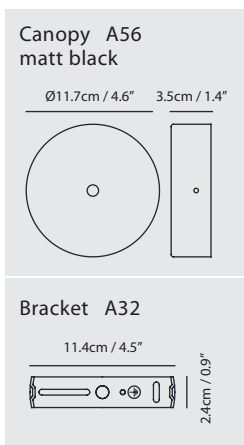
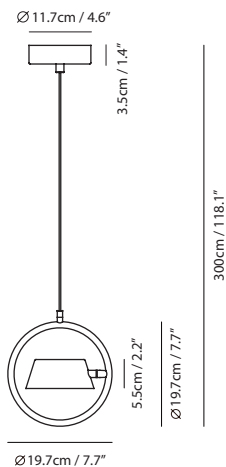

**OLO Ø Pendant P1**

**Model**  
SLD-130P

**Material**  
steel, PP

**Light Source**  
LED x 8W 3000K CRI>90 415lm

**Driver**  
Built-in dimmable driver  
(Triac dimming)

**Weight**  
0.9kg / 2lb

- Color**
- shiny black shade + matt black
  - champagne gold shade + matt black
  - pearl cocoa shade + matt black



OLO  $\Phi$  has revolutionized the world of light fixtures by incorporating the diameter symbol  $\Phi$  into their designs. This subtle touch adds an elegant and unique element to the basic elements of a circle and line. The result is a finely welded frame that is reminiscent of the illustrious Saturn ring, gracefully embracing the floating and flipping lamps within its arms. This petite lantern style table lamp offers an abundance of warm and soft light, almost like a soothing aria.

By Li, Hui Lun 李慧倫



shiny black shade +  
matt black



champagne gold shade +  
matt black

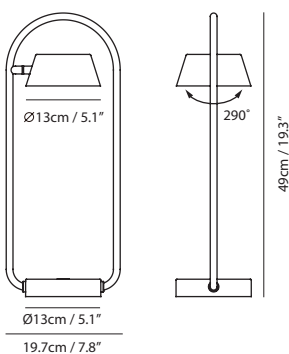

**OLO Φ Table**

**Model**  
SLD-130DTE

**Material**  
steel, PP

**Light Source**  
LED 6.5W 3000K CRI90 415lm

**Feature**  
Touch dimmer switch

**Weight**  
1.4kg / 3.1lb

**Cord**  
200cm / 78.7"

**Color**

- shiny black shade + matt black
- champagne gold shade + matt black



Introducing our latest addition to the collection: the OLO Φ Portable. This rechargeable light is the epitome of form and function, offering superior flexibility and ease of use.

With its signature design, from the hollow lampshade to the 290-degree rotation, the OLO Φ Portable not only adds a touch of elegance to any indoor space but also illuminates your outdoor adventures. This lamp is available in a wide range of versatile color combos, unveiling a perfect range for you.

By Li, Hui Lun 李慧倫



champagne gold shade + matt black



shiny black shade + matt black



coral orange shade + matt black



olive green shade + champagne gold

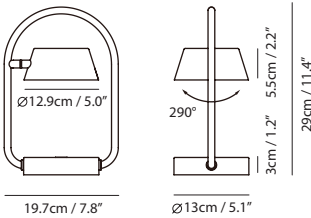

**OLO Φ Portable**





**Model**  
SLD-130DC

**Material**  
steel, PP

**Light Source**  
LED 3W 2700K CRI>90 255lm

**Feature**  
Touch dimmer switch, Rechargeable

**Weight**  
1.2kg / 2.6lb

- Color**
-  champagne gold shade + matt black
  -  shiny black shade + matt black
  -  coral orange shade + matt black
  -  olive green shade + champagne gold

\* 5000mAh Battery Capacity; Use the Type-C cable in the parts bag to charge the product.  
 \* Place away from ignition sources, and avoid a high-temperature environment in use.  
 \* Indicator: Lights up in red while charging; turns green when charging is complete.  
 \* 8hrs working time after full charge. (It takes 4 hours to complete charging with 5V 2A input)







shiny black



champagne gold

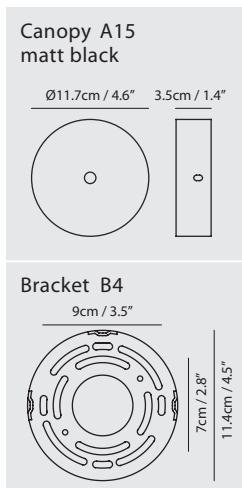
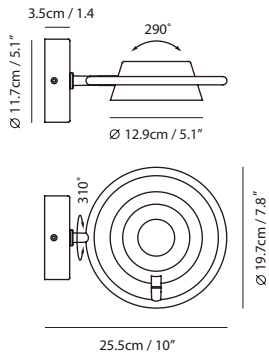

**OLO Φ Wall / Ceiling**

**Model**  
SLD-130CW

**Material**  
steel, PP

**Light Source**  
LED 6.5W 3000K CRI90 415lm

**Driver**  
Built-in dimmable driver (triac dimming)

**Weight**  
0.8kg / 1.8lb

**Color**  
 shiny black shade + matt black  
 champagne gold shade + matt black