

Components

- 1 X Gearwheel (a.1)
- 1 X Gearwheel (a.2)
- 30 X Slats (b)
- 1 X Electrical assembly (c)
- 1 X LED bulb E26 Warm light recommended (up to 20W)

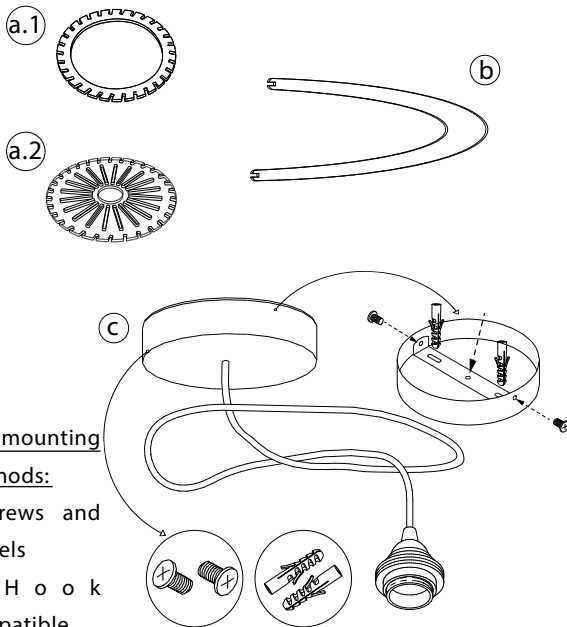

Two mounting methods:
1- Screws and dowels
2 - Hook compatible

A big thank you !

We are happy to have you on board with Atelier Loupiote and thank you for helping to grow this project that means so much to us.

Something radiant awaits you!

Conceived in our minds and crafted by our hands, all our luminaires are brilliantly made in our workshop in Lyon to ensure **100% local production.**

And to stay tuned, you can follow us on Facebook and Instagram! (content in french only)
Atelier-loupiote.fr

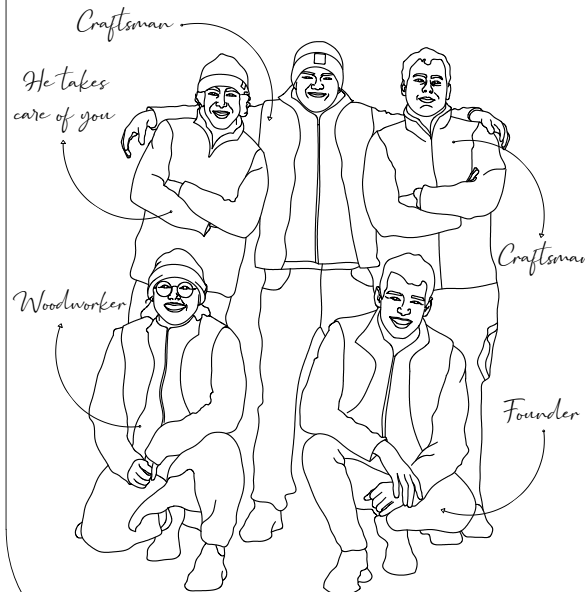

Our Loupiote team

ATELIER
Loupiote

X

 KIPLI

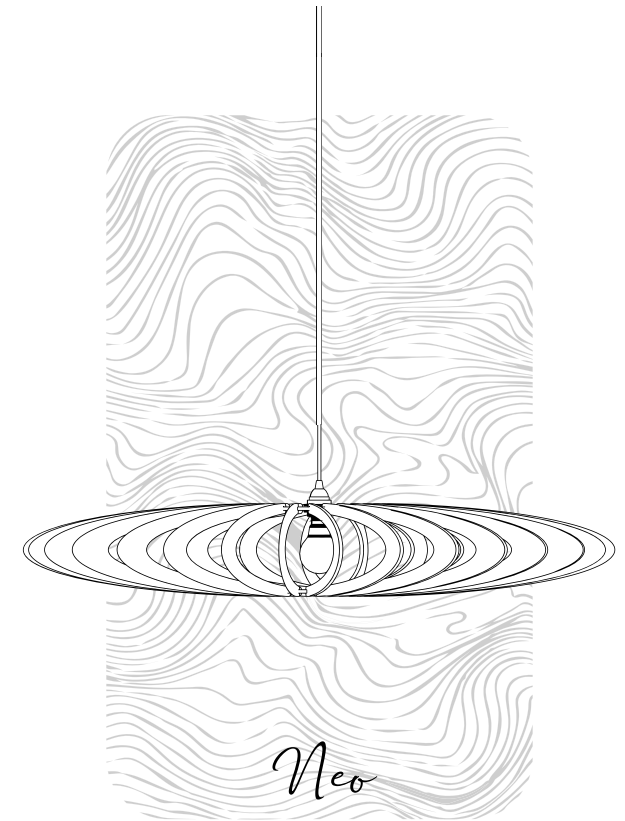

Our manual

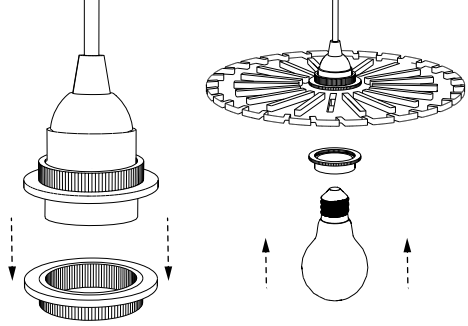

- 1 Unscrew the lower tightening ring of the socket. Insert the socket into the big gearwheel (a.2) and screw the ring back in place. Tighten both rings to securely hold the gearwheel (a.2) in place. Plug a LED bulb E26 into the socket.

For each slat, the short side should fit into the large gearwheel (a.2), and the long side into the small gearwheel (a.1).

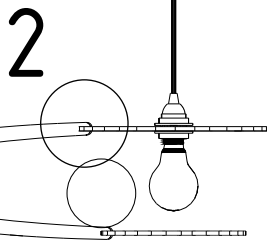

- 3 Insert a slat (b) in both gearwheels following the instructions of last step.

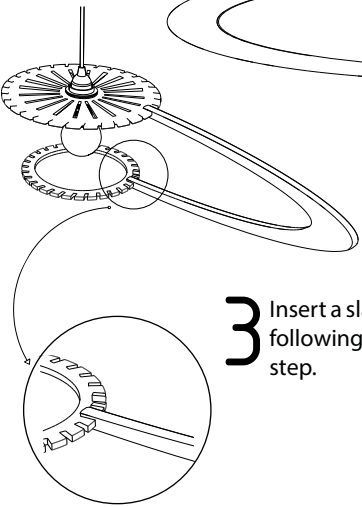

Insert a slat (b) on the opposite side in order to stabilize the model and facilitate the remainder of the assembly.

4

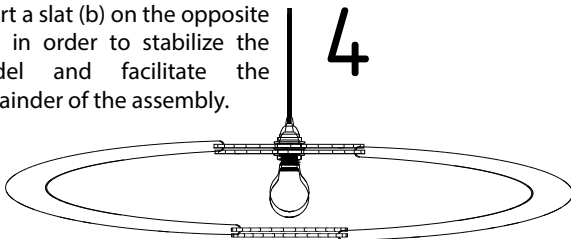

CAUTION !

Please make sure to cut off the electricity and seek assistance from a professional for the connection. Only turn on the electrical equipment once the assembly is complete and the bulb is screwed in place.

PRELIMINARY INFORMATION :

Some parts are fragile, handle them with care. We recommend setting up on a flat and stable surface to reduce the risk of breakage.

ARE YOU READY ?

Don't panic, we'll explain everything. Say goodbye to glue and tools; you only need your two hands for assembly. Pinky promise, it's a breeze. The parts are designed to fit together effortlessly. Just go with the flow!

NEED HELP ?

If you encounter any issues and require technical support, please contact our workshop directly via email at the following address: hello@atelier-loupiote.fr. We'll be happy to assist you.

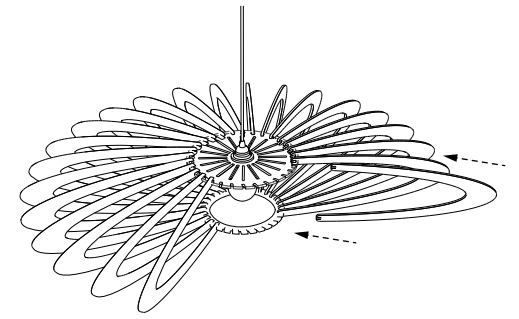

Keep inserting slats (b) until you complete the assembly.

5

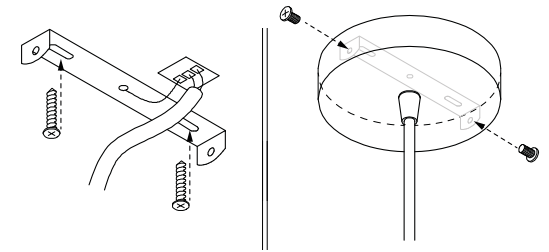

- 6 Adjust the cable. Screw the support bar into the ceiling, connect the cable to the power supply, and fasten the ceiling rose using the two screws. We recommend having this step done by a professional if you don't feel confident in handling the electrical system.

And you're done !

