

IN THE TUBE

by Dominique Perrault
& Gaëlle Lauriot-Prévost

DCWéditions
PARIS



Visit us at:
www.dcwe.fr

**INSTRUCTION
& USE SHEET US**

CONTENU / IN THE BOX

	× 1
	× 1
	× 2
	× 2
	× 2
	× 3
	× 2
	× 2

OUTILS NÉCESSAIRES / REQUIRED TOOLS

	Ø 8
		
		
		

ATTENTION

- La sûreté de l'appareil n'est garantie qu'en suivant scrupuleusement les instructions précédentes. Il est donc nécessaire de les conserver.
- Isoler l'appareil du secteur avant toute manipulation.
- L'appareil ne peut pas être installé dans une autre position que celle indiquée dans les instructions de montage.
- Le montage et les manipulations de l'appareil devront être exécutés avec la plus grande attention pour ne pas abîmer ses composants.
- Tout changement d'ampoule respectera le type et la puissance indiqués dans le descriptif technique.
- Les composants métalliques, en verre ou autre seront entretenus à l'aide d'un chiffon doux et de détergent neutre.
- DCW ÉDITIONS n'échangera ses articles défectueux que par l'intermédiaire d'un revendeur.
- En cas de doute sur le branchement de cette lampe, veuillez consulter un électricien qualifié. Tout câble endommagé doit être remplacé par un professionnel qualifié.

WARNING

- The safety of this fixture is only guaranteed if the instructions have been observed.
- Always disconnect power before working on fixture.
- Fixture must not be installed in any position other than that shown in instructions.
- Assembly and maintenance of fixture must be performed carefully so as not to damage components.
- Replacement bulbs must be of same type and wattage as specified in instructions.
- Metal surfaces, glass or other parts of fixture may be cleaned with a soft damp cloth and mild detergent.
- DCW ÉDITIONS will replace merchandise with manufacturing defects only if it is returned to the retailer from which it was purchased.
- If you are unsure about your wiring, please consult a qualified electrician. The damaged cables should be changed by manufacturer or distributor or qualified electrician.



Suspension / Ceiling lamp



Applique horizontale / Horizontal wall lamp



Applique verticale / Vertical wall lamp

EN SUSPENSION / AS A CEILING LAMP

Fr INSTRUCTIONS

1. Percez selon l'entraxe indiqué
2. Fixez les platines
3. Passez le câble métallique dans le canon
4. Vissez le canon sur la platine
5. Passez le câble métallique dans l'étrier et bloquez la position à l'aide de la sphère
6. Positionnez la lampe dans les étriers et verrouillez
7. Réglez la hauteur

En INSTRUCTIONS

1. Make holes according to the measurement between the two holes
2. Fix the ceiling mounts
3. Place the steel cable into the retaining piece
4. Screw the retaining piece on the ceiling mount
5. Insert the steel cable through the collar
6. Place and lock the lamp into the collar
7. Adjust the height

1

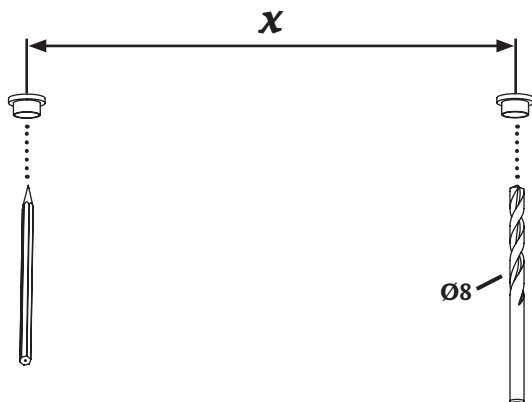

IN THE TUBE	X
100-350 →	30 cm
100-500 →	45 cm
120-700 →	65 cm
120-1300 →	125 cm

2



3

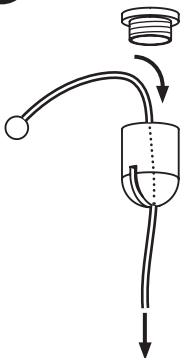

4

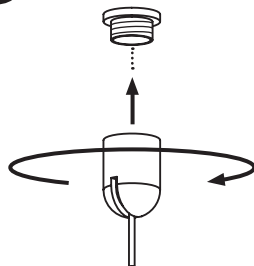

5

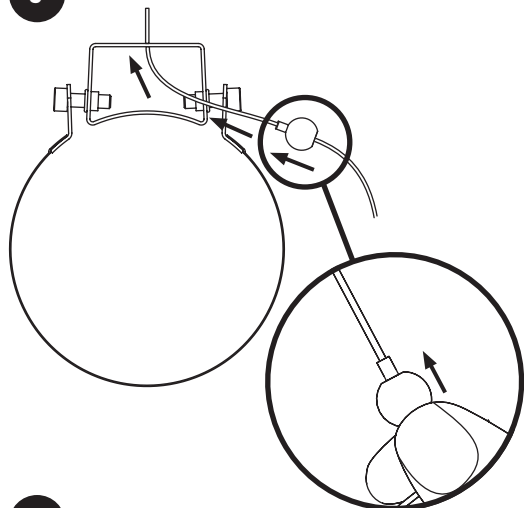

6

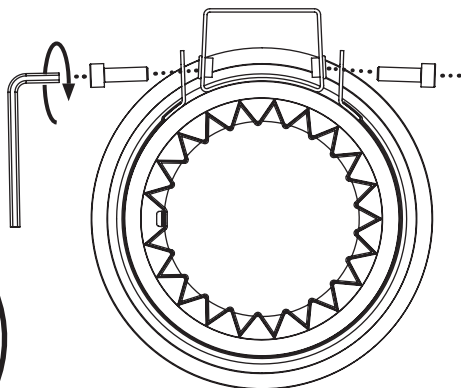

7

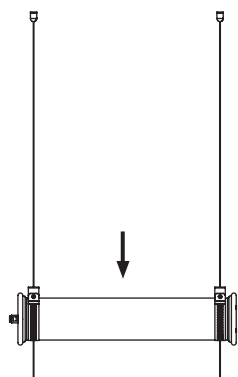

Actionnez le téton
pour descendre la
lampe / *Press the spigot
to down the lamp*

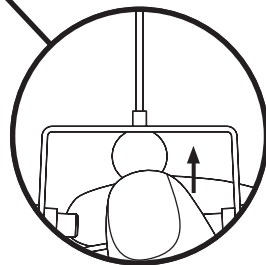
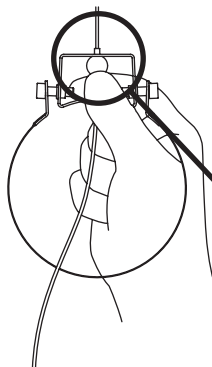
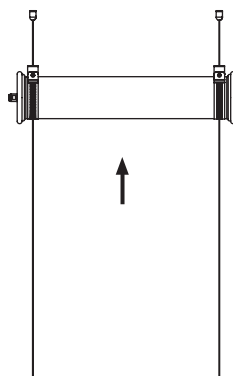
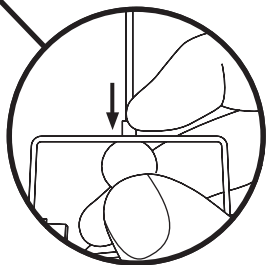
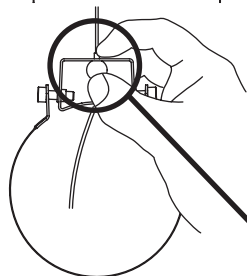

EN APPLIQUE / AS A WALL LAMP

Fr INSTRUCTIONS

1. Dévissez les pièces de l'étrier
2. Percez selon l'entraxe indiqué
3. Fixez les supports
4. Positionnez la lampe dans les étriers et verrouillez

En INSTRUCTIONS

1. Unscrew the collar
2. Make holes according to the measurement between the two holes
3. Fix the wall mounts
4. Place and lock the lamp into the collar

1

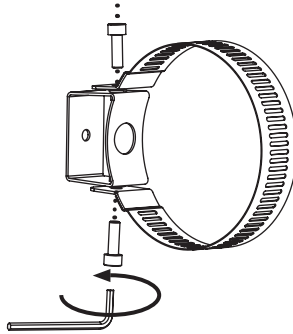

2

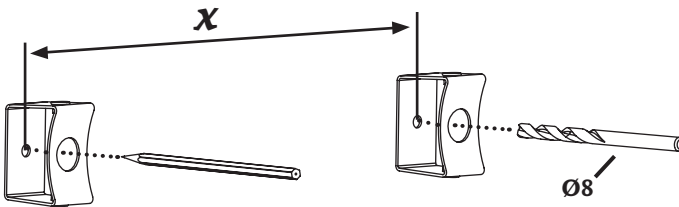

IN THE TUBE	x
100-350 →	30 cm
100-500 →	45 cm
120-700 →	65 cm
120-1300 →	125 cm

3

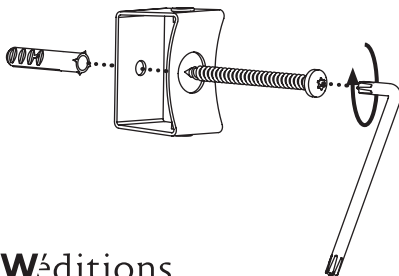

4

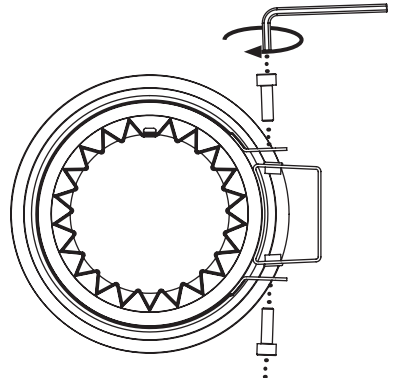

BOÎTIER DE CONNEXION / TERMINAL BOX

Fr INSTRUCTIONS

1. Dévissez les 2 vis
2. Fixez la platine au boîtier
3. Percez les joints avec un tournevis
4. Passez le câble et fixez la platine
5. Connectez les deux câbles
6. Revissez le capot de protection

En INSTRUCTIONS

1. Unscrew the 2 screws
2. Fix the wall mount to connection box
3. Pierce the seals with a screwdriver
4. Block the cable with the cord grip
5. Connect the wires
6. Close and screw the connection box

1

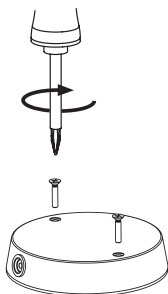

2

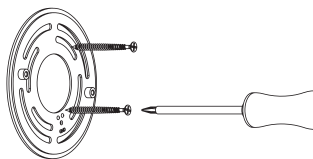

3



4

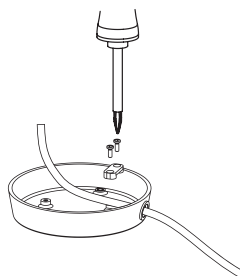

5

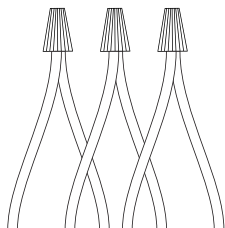

6

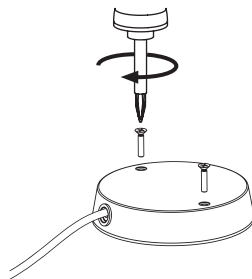

CHANGER LES AMPOULES / REPLACE THE BULBS

Fr INSTRUCTIONS

1. Dévissez le bouchon opposé à la sortie de câble
2. Glissez le corps hors du tube de verre avec des gants blancs
3. Placez les ampoules
4. Repositionnez les éléments et vissez fermement le bouchon dans l'axe

En INSTRUCTIONS

1. Unscrew the rubber plug opposite from the wire exit
2. Slide the lamp body out of the glass tube with white gloves
3. Place the bulbs
4. Reassemble the elements then screw firmly the plug in the axis

1

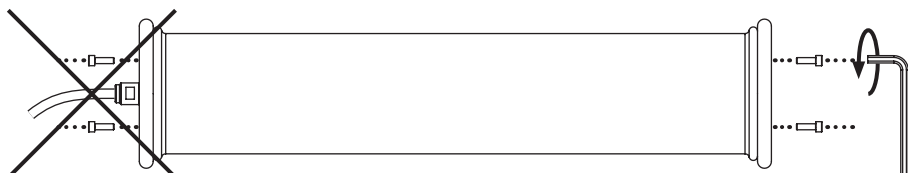

Ne jamais dévisser ce côté /
Never unscrew this side

2

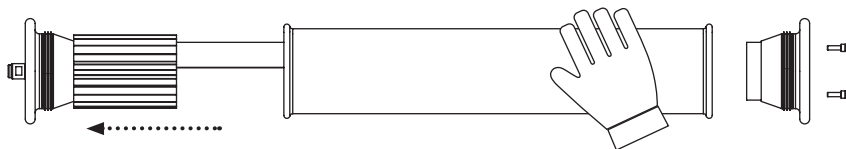

3

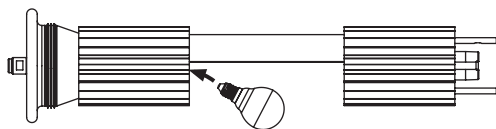

IN THE TUBE	Type	Qty.
100-350 →	E 12 →	2
100-500 →	E 12 →	2
120-700 →	E 26 →	4
120-1300 →	E 26 →	6

4

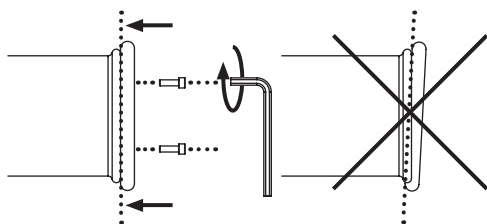

L'étanchéité de votre lampe dépend du bon positionnement du bouchon contre le tube de verre / Place the rubber plug perfectly against the glass tube, in order to keep its waterproof property